



# Hardware and Operations Manual

## SICRIT® SC-30X Ionization Set

consisting of

SICRIT® Control Unit SC-30 and SICRIT® Ion Source



Release January 2020

Plasmion GmbH - Am Mittleren Moos 48 - 86167 Augsburg - Germany

This manual has to be stored carefully and must be at hand to any user of the described system. In addition to this guide, Plasmion GmbH provides installation manuals for SICRIT® interfaces and additional modules. For installation and operation of interfaces and modules Plasmion refers to specific information in the respective manuals.



**Attention!**

Please read and understand this manual before operating the described system. In case you discover obvious errors or contradictions for your product, contact the manufacturer before operating the system.

The content of this document has been checked thoroughly and is believed to be reliable. However, Plasmion GmbH does not assume any responsibility for damages of foreign or own products and instruments resulting from improper use or any combination of the product with other instruments. Plasmion GmbH is not liable for consecutive damages resulting from integration and/or operation of its products in/with other systems. If the system is used in any manner not specified by Plasmion GmbH, the protection of the system could be impaired. Plasmion GmbH is not responsible for ignoring the outlined safety guidelines or the misuse of this system.

The technology and application of the system described in this manual is covered by patents and patent applications and is used under license.

All trademarks are property of their respective owners.

## Declaration of conformity

The products outlined in this manual are engineered and build according to the requirements of electrical safety and health protection as outlined in the EC low voltage directive and the electromagnetical compliance (EMC) directive. Any change or modification of any of the referred products, not verified by Plasmion GmbH, voids this declaration.

Plasmion GmbH certifies that the

**SICRIT® SC-30 Control Unit** and the

**SICRIT® Ion Source**

are designed and build to meet the EU Regulation No. 2014/35/EU (low voltage directive) and the Guideline 2014/30/EU (EMC Directive). The products fulfill the following safety requirements and safety standards for electrical measurement, control and laboratory use:

IEC/EN 61010-1:2010



The products fulfill the following directives for electromagnetical compliance of electrical measurement, control and laboratory use:

IEC/EN 61326-1:2012, Class A

CISPR 11/EN 55011:2009





The products are compliant with RoHS-Guideline 2011/65/EU.



<p><b>EG Konformitätserklärung</b> EC Declaration of conformity</p>		
Name des Herstellers: manufacturer's name	Plasmion GmbH	
Adresse des Herstellers manufacturer's address	Am Mittleren Moos 48 86167 Augsburg Germany	
<p><b>Der Hersteller erklärt, dass das Produkt</b> The manufacturer declares that the following product</p>		
Name des Produkts: product name	SICRIT Ionization Set	
Name des Modells: model name	SC-30X	
<p><b>mit den folgenden EG Richtlinien und harmonisierten Standards übereinstimmt:</b> is in conformity with the following EC Directives and harmonized standards:</p>		
Niederspannungsrichtlinie Low Voltage Directive 2014/35/EU	EN 61010-1:2010	
EMV-Richtlinie EMC Directive 2014/30/EU	IEC/EN 61326-1:2012, Klasse /class A CISPR 11/EN 55011:2009	
Ergänzende Informationen: Complementary information	Das Produkt hält die RoHS-Bestimmungen ein The product is in conformity with RoHS Directive 2011/65/EU	
Augsburg, Germany, 30. Juli 2018	 <hr/> <p>Jan-Christoph Wolf Geschäftsführer Executive Director</p>	

## Safety Instructions

The following safety labels on the product and within this manual indicate safety risks and necessary precautions that arise during installation or from operating the products.

	<p>[Attention!], marks possible dangers to your safety and health.</p>
	<p>[Dangerous Voltage!], indicates parts and situations where there is the risk of exposure to dangerous electrical voltages.</p>
	<p>[Attention Hot Surface!], indicates potentially hot surfaces that might cause burning injuries if touched without protective gear.</p>
	<p>[Note], marks important information or advice, not related to safety issues.</p>

## Table of Content

Declaration of conformity.....	ii
Safety Instructions .....	iv
1. Intended Use of the SICRIT® SC-30X Ionization Set .....	1
1.1 The SICRIT® Technology .....	1
1.2 The SICRIT® SC-30 Control unit.....	1
1.3 The SICRIT® Ion source.....	1
1.4 Guidelines and directives.....	2
2. Technical Data .....	3
2.1 Ambient conditions.....	5
2.2 In- and outputs of the SICRIT® Control unit SC-30.....	5
3. Installation of the SICRIT® Ionization Set SC-30X.....	7
3.1 Setting up the SICRIT® Control unit SC-30 .....	7
3.2 Connecting the SICRIT® Ion source to the SICRIT Control unit.....	7
3.3 Connection of the optional modules.....	7
4. SICRIT® SC-30 Control Unit Operation .....	8
4.1 Operation of control unit using display user interface .....	8
4.2 Menu navigation.....	9
5. Service and Maintenance of SICRIT® SC-30 Control Unit .....	14
5.1 Cleaning and Decontamination .....	14
5.2 Checking the SICRIT® SC-30 Control unit.....	14
5.3 Integration into other systems.....	15
6. Risk Avoidance or Residual Safety Risks.....	16
7. Operation with Potentially Harmful Substances.....	16
8. Troubleshooting the SICRIT® Control Unit SC-30 .....	17
8.1 Problem: The SICRIT Control unit SC-30 does not turn on .....	17
8.2 Problem: Error Message: LOW VOLTAGE AT HV-OUTPUT DETECTED .....	17
8.3 Problem: Error Message: HV AMPLIFIER.....	18
8.4 Problem: Error Message: THERMOFUSE TRIPPED .....	18
8.5 Problem: Error Message: MOUNTING OF SD-CARD FAILED.....	19
8.6 Problem: Error Message: IMPORT OF CONFIGURATION FAILED .....	19
9. Installation of the SICRIT® Ion Source .....	20
9.1 Installation preparation .....	21

9.2	Mounting the Ion source .....	21
10.	Setup and Operation of the SICRIT® Ion Source.....	24
11.	Service and Maintenance SICRIT® Ion Source.....	26
12.	Troubleshooting the SICRIT® Ion Source.....	28
12.1	Problem: The TIC is Spiking unexpectedly .....	28
12.2	Problem: Instable MS signals .....	28
13.	Replacement and Spare Parts.....	30

## 1. Intended Use of the SICRIT® SC-30X Ionization Set

The system described is intended for use only in laboratory and/or R&D environment. If the system is used in a way not specified by the manufacturer, misused or modified causing an infringement of the safety measures, Plasmion GmbH refuses any liability for consecutive damages in any form.

### 1.1 The SICRIT® Technology

Soft Ionization by Chemical Reaction In Transfer (SICRIT®) is a flow through ionization technique to be coupled with mass or ion mobility spectrometers. Inside the ion source a cold plasma is used for ionization of the analytes passing through. This enables direct gas phase measurements as well as coupling with chromatographic systems as GC or HPLC. The latter requires additional coupling modules.

### 1.2 The SICRIT® SC-30 Control unit

The SICRIT® SC-30 is the main control unit for the ionization as well as other combinable modules supplied by Plasmion GmbH. This includes ion source and e.g. the GC/SPME-Module (a full list of currently available SICRIT add-on modules can be found on [plasmion.de](http://plasmion.de)). The control unit and all add-on modules are intended for indoor use in laboratory R&D environment.

### 1.3 The SICRIT® Ion source

The SICRIT® Ion source is intended for coupling with the inlet of a mass spectrometer (MS) to ionize gaseous or aerosol components drawn into the system. Its internal plasma is controlled and empowered by the SC-30 control unit. For connection with the SC-30 the originally supplied cables must be used. The ion source is intended for use in laboratory R&D environment.

The mechanical connection with the MS is realized by the respective MS adapter interface supplied by Plasmion GmbH. Please refer to the respective interface information and installation guide supplied for your specific MS system for further details.

The possible flow rates through the source depend on the MS inlet flow. Typical flow rates are in the range of 0.5 – 1.5 L/min. To avoid damage of your MS system do not overpressure the inlet of the connected SICRIT ion source, although a gas tight connection is possible.



## 1.4 Guidelines and directives

The control unit and the ion source are designed and build to meet following European legislative standards:

- EU directive 2014/35/EC (Low Voltage Directive)
- EU directive 2014/30/EU (EMC Directive)
- EU directive 2011/65/EU (RoHS 2)

Labeling and marks can be found on the bottom plate of the control unit and the label of the ion source.

## 2. Technical Data

### SICRIT® Control Unit SC-30



Dimensions	270 x 200 x 80 mm
Weight	2.1 kg
Supply Voltage	100-240 VAC 50-60 Hz max. 400 W
Power Connector	Connector type IEC/EN 60320-1/C14 
Fuses	2 x 2.0 A-T
IP-Code	IP30
Protective class	II
HV - Output	2 x 0 - 1100 VAC (0 - 3000 V <sub>pp</sub> ) 10.0 - 50.0 kHz max. 100 W
Modules Output	24 VDC max. 100 W
Operation Temperature	5 °C to 40 °C
Storage Temperature	20 °C to 100 °C
Operation Humidity	< 80% RH (non condensating)

## SICRIT® Ion Source

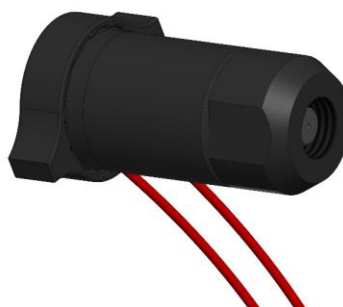

Dimensions	45 x 20 x 20 mm
Weight	150 g
Supply Voltage (supplied by the control unit)	2x 0-1100 VAC (0-3000 V <sub>pp</sub> ) 10.0 – 50.0 kHz max. 100 W
Electrical connectors	2 Pin HV quick lock connectors Only use the originals cables!
IP-Code	IP30 (open system) IP40 (gas-tight connection to ion source)
Protective Class	II
Operation Conditions	5 °C to 60 °C surface temperature < 80% RH (non condensating)
MS Interface / Sheat Gas Temperature	max. 250° C
Storage conditions	-20° C to 100° C < 80% RH (non condensating)
Carrier Gas Temperature (flow through)	5 °C to 250° C (continuous), to 320 °C (short-term) 0 to 90% RH (non condensating)
Possible Carrier Gases	Air, N <sub>2</sub> , CO <sub>2</sub> , Helium* *contact the product support for further information
Flow rate	Depending on MS instrument (typically 0.5 – 1.5 L/min)
Note	A specific SICRIT® MS interface is required for connection and operation

## 2.1 Ambient conditions

- Indoor use in laboratory R&D environment (maximum altitude 2000 hm)
- Transient and temporary overvoltage according to overvoltage categorie II of main supply voltage
- Rating of pollution degree 2 (slight contamination)

## 2.2 In- and outputs of the SICRIT® Control unit SC-30

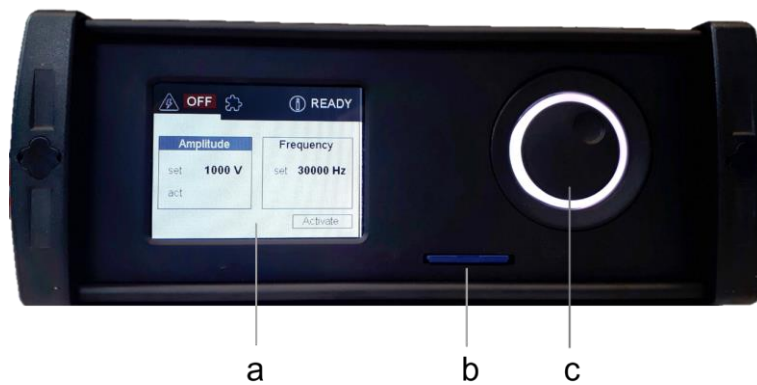

Figure 1: SICRIT® SC-30 front view.

- a) Display for direct control via user interface
- b) SD card slot with SD card
- c) Rotary encoder as control element (with color coding status LED ring)

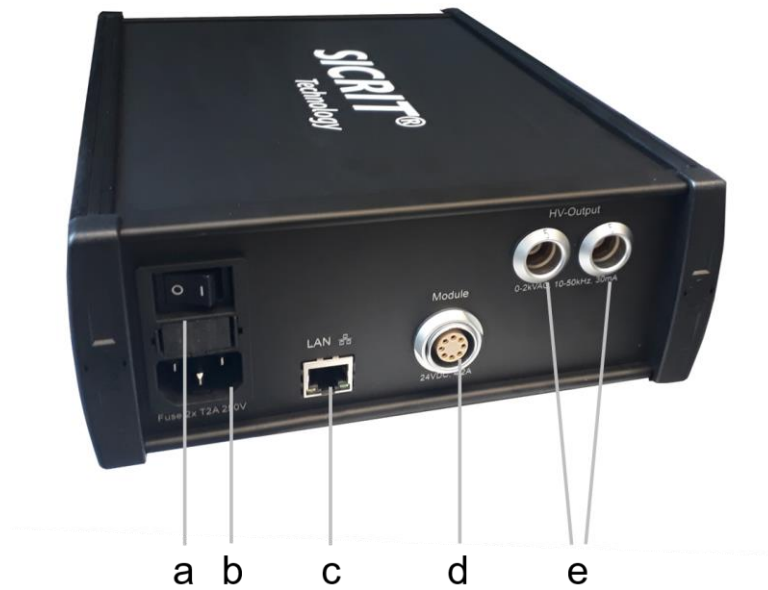

Figure 2: SICRIT® SC-30 rear view with ports.

- a) Main power switch On/Off
- b) Power input: type IEC/EN-60320-1/C14, 100-240 V, 50-60 Hz, 400 W
- c) Ethernet port (for optional remote control)
- d) Modules output: GC-SPME module  
(24 VDC, 100 W; thermal stability of port: 80 °C)
- e) HV-Output Ion Source: 0-1100 VAC, 10-50 kHz, max. 100 W, thermal stability of port: 80 °C,  
please pay attention to maximum bending radius of 4 cm

### 3. Installation of the SICRIT® Ionization Set SC-30X

#### 3.1 Setting up the SICRIT® Control unit SC-30

Take the device out of the packaging case and check it for visible damages. Place it on a firm surface and ensure sufficient air circulation. Do not use the device as base for other devices! Connect the unit to the power grid by the supplied cables on port (Fig. 2b). Operate the device only on a grounded plug socket with at minimum 16 A protection (100–240 V, 50–60 Hz). Turn on the system by pressing the integrated main power switch (Fig. 2a).

#### 3.2 Connecting the SICRIT® Ion source to the SICRIT Control unit

**TURN OFF** the SC-30 Control unit, using the main power switch (Fig. 2a). The control unit has to be turned off for every plugging operation.

To connect the ion source plug in the connection cables in the corresponding sockets (Fig. 2e). There is no orientation of the cables! Check if the connections are clicked firmly into place.



Attention!

The HV-Output can supply voltages up to 1100 VAC. Never unplug the device during operation of the system and ensure correct connection of both plugs!

#### 3.3 Connection of the optional modules

**TURN OFF** the SC-30 Control unit, using the main power switch (Fig. 2a). The control unit has to be turned off for every plugging operation.

All SICRIT® modules e.g. the GC/SPME Module are connected to the control unit via port (Fig. 2d). After any manipulation check if the connections are clicked firmly into place. Please refer to the specific module installation guide supplied with your product.

Correct plugging will unlock the module tab menu in the user interface.

## 4. SICRIT® SC-30 Control Unit Operation

### 4.1 Operation of control unit using display user interface

Turn on the main power switch (Fig. 2a). During software loading the LED ring will turn blue and the Plasmion logo will be displayed. The display should respond within 5 seconds and show the following screen (Fig. 3).

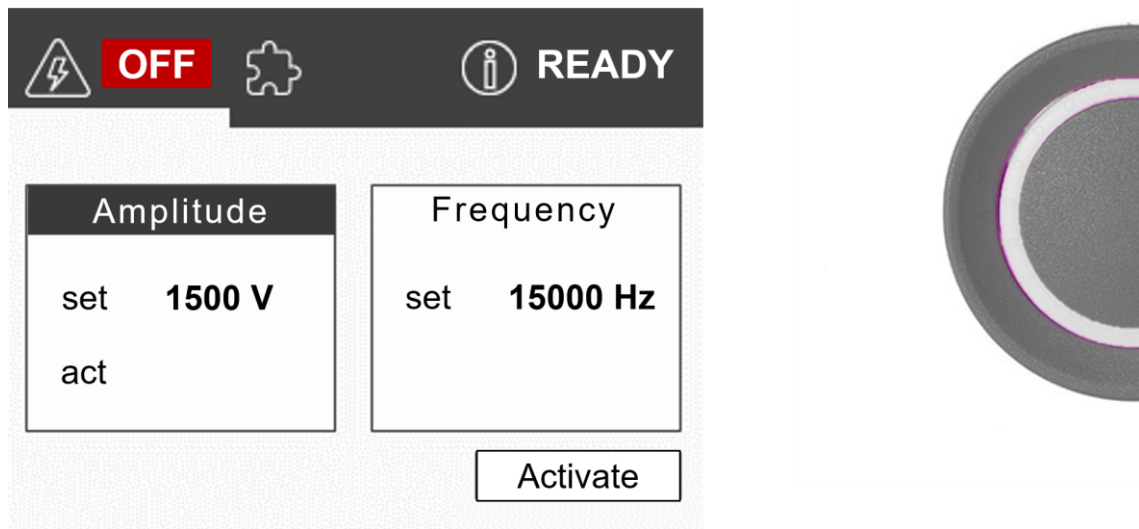

Figure 3: Front panel with display and HV starting screen (without module) and rotary encoder for SC-30 operation. The LED ring codes following device status: Booting (blue), Control unit on (white), loading SD card parameters (green, blinking), HV output (purple), Module output (cyan), error (red, blinking)

The SC-30 system is controlled via a rotary encoder on the front panel. Inputs are given by rotating and pressing the encoder. Pressing allows for selecting the tabs and settings, rotation allows for setting values or moving between menu tabs and windows. Set and actual values are always displayed but can only be modified, if the respective position is selected. The actual cursor position is indicated by white letters on grey background. After pressing the encoder button on the window menu, the set value can be modified. The active menu is indicated by bold white letters on white background. Non-active positions are indicated by black letters on white background.

## 4.2 Menu navigation

The software user interface of each tab is composed of the status header, the menu window(s), and the activation button. The header shows the status of the ion source, the optional modules, and the Ethernet connection. HV output is visualized by the voltage symbol and ON (green background) or OFF (red background), respectively. In case of connecting an additional SICRIT module, the puzzle symbol is complemented by ON (module activated)/OFF. The connectivity status is indicated by READY and ON/OFF, respectively).

The setting options in the tab windows are briefly explained below.

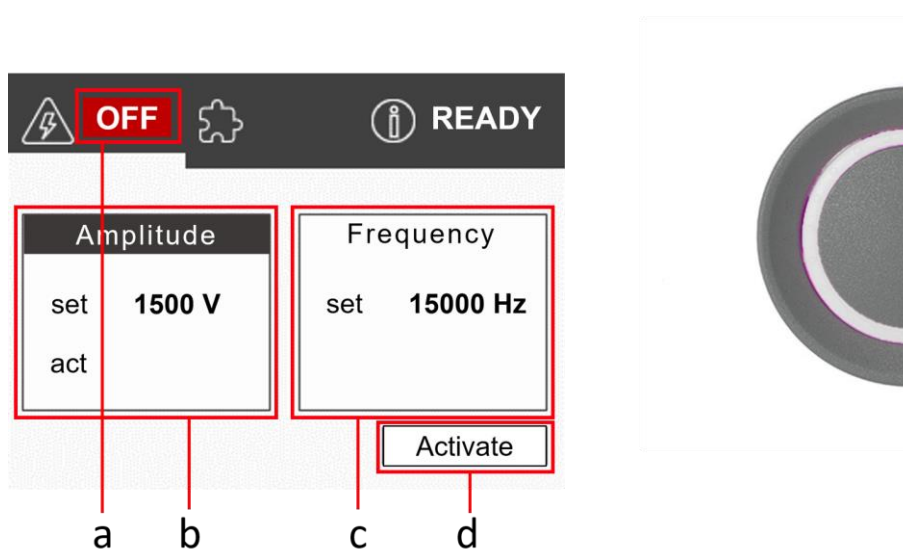

Figure 4: Active tab for ion source/HV settings.

- a) Actual status of HV-Output ON/OFF
- b) Menu window for setting of voltage set/act
- c) Menu window for setting of frequency set
- d) Button for activation of HV output Activate/Deactivate

The ion source tab allows for adjustment the HV settings supplying the ion source and, therefore, the cold plasma conditions. The HV output can be modified in terms of voltage and frequency. The voltage value displayed corresponds to the *peak-to-peak* amplitude  $V_{pp}$  of the AC sinus-wave.

The voltage set value can be modified in steps of 50 V, the maximum output voltage is limited to 2500  $V_{pp}$  for frequencies below 25 kHz, and 3000  $V_{pp}$  for for frequencies above 25 kHz. Depending on the measurement conditions, typical operation voltages lie between 1000  $V_{pp}$  and 1600  $V_{pp}$ . The frequency can be set to values between 10 kHz and 50 kHz in steps of 250 Hz.



When a high voltage is supplied by pressing the **ACTIVATE**-Button, the color of the rotary encoder will turn purple and the active output is indicated by **ON** besides the voltage symbol in the display.

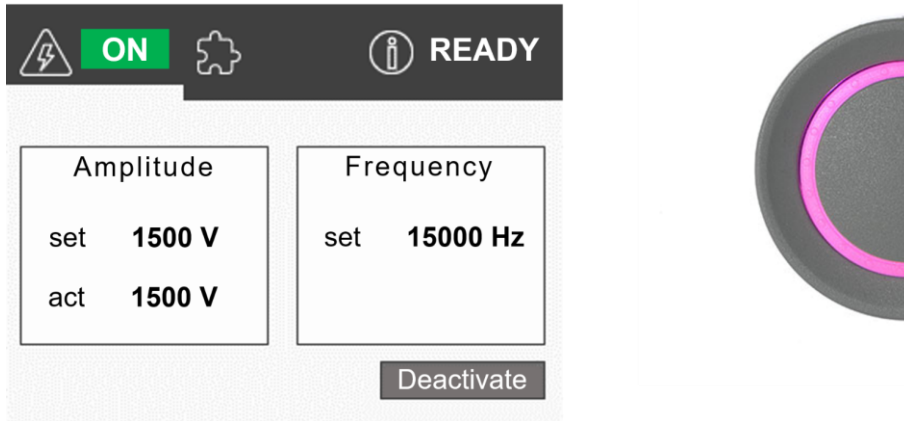



Figure 5: User interface and rotary encoder after activation of HV output.

The software allows for adjustment of voltage and frequency values during operation (HV output active) giving the opportunity to modify the plasma conditions in real time during measurements. Please change the set parameters in small steps to avoid overvoltages and overloading of the electronics.

	<p>Attention!</p> <p>The HV-Output can supply voltages up to 1100 VAC. Never unplug the device during operation of the system and ensure correct connection of both plugs!</p>
---	--

	<p>The software allows for adjustment of voltage and frequency values during operation (HV output active). To avoid overloading of the electronics, please do not vary the set values in short time intervals and wait until the actual value reaches the target value.</p> <p>In exceptional case of overloading, the system will shut down and the error code <i>Low Voltage at HV-output detected</i> will be displayed in the status window.</p>
---	--

The module tab allows for setting parameters of optional modules and is only active in case of plugging a module in port (Fig. 2d). In Figure 6, the module tab is depicted on example of the GC/SPME Module.

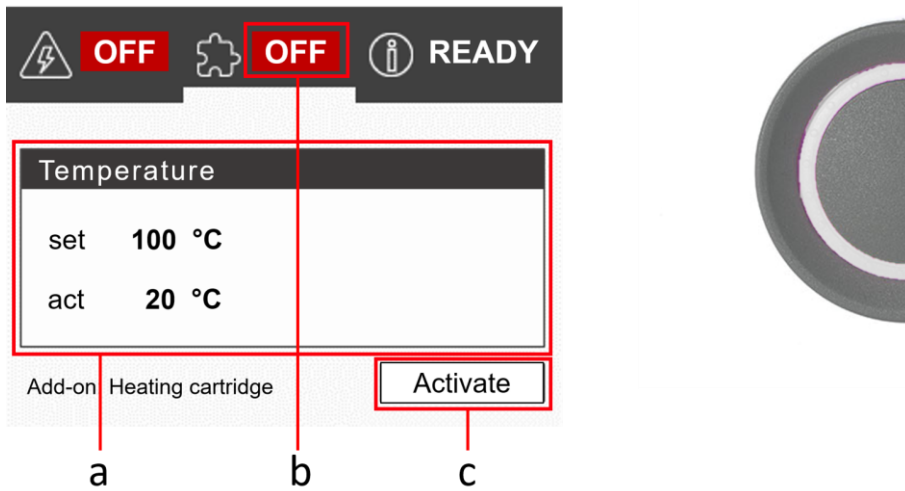

Figure 6: Active tab window for control of optional modules.

- a) Menu for temperature settings set/act
- b) Actual status of module output ON/OFF
- c) Button for activation of module output Activate/Deactivate

Connecting heating systems, e.g. the SICRIT® GC/SPME Module, the temperature can be controlled in the module tab. Depending on the connected module, the set value (1°C steps) of the temperature is limited in accordance to the module function (i.e. 320 °C for the GC/SPME Module). The heating controller is activated after confirmation of the ACTIVATE-Button, indicated by cyan LED ring lights and ON status besides the puzzle symbol (Fig. 7; in case of concurrent HV output, the LED ring will show purple lights).

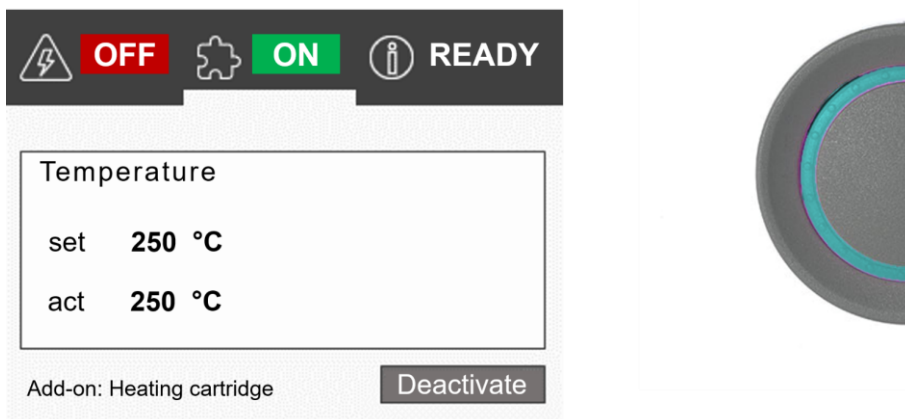



Figure 7: User interface and rotary encoder after activation of module output.



The PI heating control of the GC/SPME Module is designed for fast desorption ramps. By heating straight to maximum operation temperature (rt to 320 °C) there is the possibility of a short overshooting of the heating. The system should reach stable temperature within 10 minutes. For best performance, set a value 10% below the desired value and increase it to the desired final temperature when the set value is reached.

The information tab gives information about the actual system status and shows error messages. In operational condition, the message “Device configuration imported from SD-card” is displayed. In error case (red-blinking LED ring), the respective error message will be displayed in the status box. To quit the error message and reset the system, set the message window active by pressing the encoder button and then hold the encoder button pressed for a second time at least for one second. Reset and reload of parameter presettings is indicated by white LED ring lights and the status dialog “No messages present”.

The control unit can be optionally operated by remote desktop user interface. The status window displays the configuration of the IP-address of the Ethernet port. After confirmation of the ACTIVATION-Button, the control unit can be controlled via the desktop software and status will turn from READY to ON.

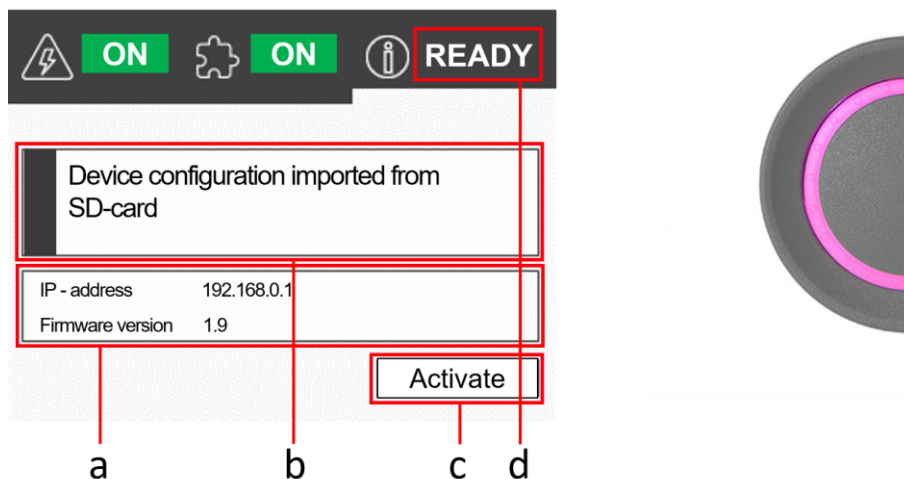

Figure 8: Active tab window with status information.

- a) Status window with information about IP-address and firmware version
- b) Menu window for status and error messages
- c) Button for activation of ethernet port Activate/Deactivate
- d) Actual status of remote connection OFF/READY/ON



After occurrence of system errors, the system can be resetted by quitting the error message.

Before restarting the system and activating the source or module output, make sure, that the cause of the fault has been identified and rectified!

In case of questions regarding the error cause, please get in contact with the product support!

## 5. Service and Maintenance of the SICRIT® SC-30 Control Unit

### 5.1 Cleaning and Decontamination

The SICRIT® SC-30 Control unit does not require any service or maintenance. In an unplugged state, the unit may be cleaned with a humid cloth. The display may be cleaned using a fine dry cloth. Any contact of the device with liquids has to be avoided!

### 5.2 Checking the SICRIT® SC-30 Control unit

The operational status of the device can be checked using the display. After turning on the device the display should show the main menu within 5 seconds. The display should respond towards inputs via the rotary encoder and not show any error messages. The set high voltage should be reached within few seconds. Heating of the optional modules should show a response within 20 seconds (except for cooldown operations or if the set and actual temperature are very close).

If the device displays an error or deviates from the described behaviour, please see the troubleshooting section of this manual.

Do not operate the system if the casing shows some obvious damages or becomes too hot (25 °C above RT).

If liquids are spilled over and/or have entered the system or any attached parts/modules, immediately disconnect the system from the power grid. Before reoperating the system, please contact the supplier.

If you encounter reasonable doubts about the functionality of the system, any attached module, or the integrated system contact the supplier before operating the device.

There are no serviceable parts inside the SICRIT® SC-30 Control unit!

The electrical fuses are accessible via the power connector. Before changing the fuses, separate the system from the power grid by unplugging the power cable. The system uses two 2.0 A-T fuses.

### 5.3 Integration into other systems

Operate the system on a power circuit that is separated from the mass spectrometer. Make sure all cables are attached and guided properly.



Make sure that all health and safety regulations are met when integrating the device into other systems.

For integration of the device into existing measurement devices or processes, it might be necessary to prepare an individual risk assessment and to ensure and deploy individual safety measures and guidelines.

## 6. Risk Avoidance or Residual Safety Risks

Regularly check the casing and cables for damages.

Ensure that access to the system is restricted for any unauthorized or untrained personnel.

Visually check the contact pins of the connectors for changes and damages.

Check if all connections are engaged before operating the system.

Never use the system without the connected ion source.

## 7. Operation with Potentially Harmful Substances

The risks of operation and handling of harmful or toxic substances that can be analyzed with the SICRIT® Ion source fall to the operator. Stick to all safety guidelines and take all necessary precautions. Ensure that the substances introduced do not damage the system. The materials used in the SICRIT® Ion source are PEEK, stainless steel and ceramics. Consider also the durability at higher temperatures.

The device itself does not contain harmful substances.

For recycling of the system, please contact the manufacturer.

## 8. Troubleshooting the SICRIT® Control Unit SC-30

In the following section problems are discussed that might occur during operation of the system. If you do not feel confident to solve the problems after this brief troubleshooting guide, please contact the manufacturer for further advice. Turn off the device and separate it from the power grid, before performing any service action.



Please support us in the further development of the devices by sending us a short description of the error, its occurrence and/or the solution via email to [support@plasmion.de](mailto:support@plasmion.de) – we appreciate your efforts!

We are further happy to receive feedback on the handling or operation, since we are always eager to improve our customers' experience.

### 8.1 Problem: The SICRIT Control unit SC-30 does not turn on

The device or the electronic is not supplied with electrical power.

Check if the display responds to turning the power button off and on. If the display stays dark, check the following points:

- Check the power connectors and sockets by means of another device (e.g. desk lamp).
- Check the fuses of the control unit and change them if necessary, as described above.
- Check if the device casing got too hot ( $> 40\text{ °C}$ ). If so, let it cool down for half an hour before turning it back on. Before reoperation, change the placement to a position where the system can dissipate its heat more efficiently, e.g. at a well-ventilated place.

### 8.2 Problem: Error Message: LOW VOLTAGE AT HV-OUTPUT DETECTED

The HV set value is not reached within the normal range of performance, so there there is a problem with HV output or HV amplifier. This error case may result from frequent changes in voltage and/or frequency changes during activated HV output.

- Before changing HV set values, deactivate the HV output
- In case of changing the set values during source operation, the actual value should reach the set value before further vary the parameters.



If the error message is not result of fast set value changes, please check following advices:

- Turn the device off. Check if all connectors are properly engaged and if the HV-cables show obvious damages. Ensure a proper cable placement.
- Check if the device got too hot ( $> 40\text{ °C}$ ). If so, let it cool down for half an hour before turning it back on. Before reoperation change the placement to a position where the system can more efficiently dissipate the heat, e.g. at a well-ventilated place.
- Check and eventually replace the plasma core (as described in the ion source maintenance section).
- Further troubleshooting assistance is available via phone or email.

### 8.3 Problem: Error Message: HV AMPLIFIER

The HV amplifier does not reach the HV set value within the the normal range of performance. This error indicates an electronic overload or hardware defect.

- Turn the device off. Check if all connectors are properly engaged and if the HV-cables show obvious damages. Ensure a proper cable placement.
- Check if the device got too hot ( $> 40\text{ °C}$ ). If so, let it cool down for half an hour before turning it back on. Before reoperation change the placement to a position where the system can more efficiently dissipate the heat, e.g. at a well-ventilated place.
- Further troubleshooting assistance is available via phone or email.

### 8.4 Problem: Error Message: THERMOFUSE TRIPPED

The GC/SPME Module is equipped with a resetting thermofuse to prevent the module from unintended overheating in case of hard- or software error. Tripping the fuse will result in switching off the heating and showing the error message in the display.

- Check, if the GC/SPME Module is freely positioned and the air can circulate. Don't cover the housing with thermal insulation material.
- If the thermofuse has been tripped, wait  $< 1$  hour for resetting of the fuse before heating up again.

## 8.5 Problem: Error Message: MOUNTING OF SD-CARD FAILED

The SD card is not loaded during booting of the device.

- Turn off the device and check if the SD card is properly inserted in the SD card slot on the front side of the control unit.
- Remove and reinsert the SD card. After reset of the system, the SD card should be detected and the firmware is loaded.
- For further troubleshooting assistance, please contact the product support.

## 8.6 Problem: Error Message: IMPORT OF CONFIGURATION FAILED

The software settings are not loaded from SD card.

- Turn off the device and check if the SD card is properly inserted in the SD card slot on the front side of the control unit. Remove and reinsert the SD card. After reset of the system, the SD card should be detected, and the firmware is loaded.
- For further troubleshooting assistance, please contact the product support.



## 9. Installation of the SICRIT® Ion Source

SICRIT® Ion sources can be attached to any MS-system equipped with a dedicated interface supplied by Plasmion GmbH. Please visit [plasmion.de](http://plasmion.de) to find out if there is an interface available for your specific MS-instrument. Please contact [support@plasmion.de](mailto:support@plasmion.de) if you are interested in a customized SICRIT® solution, or if there is no interface available yet.

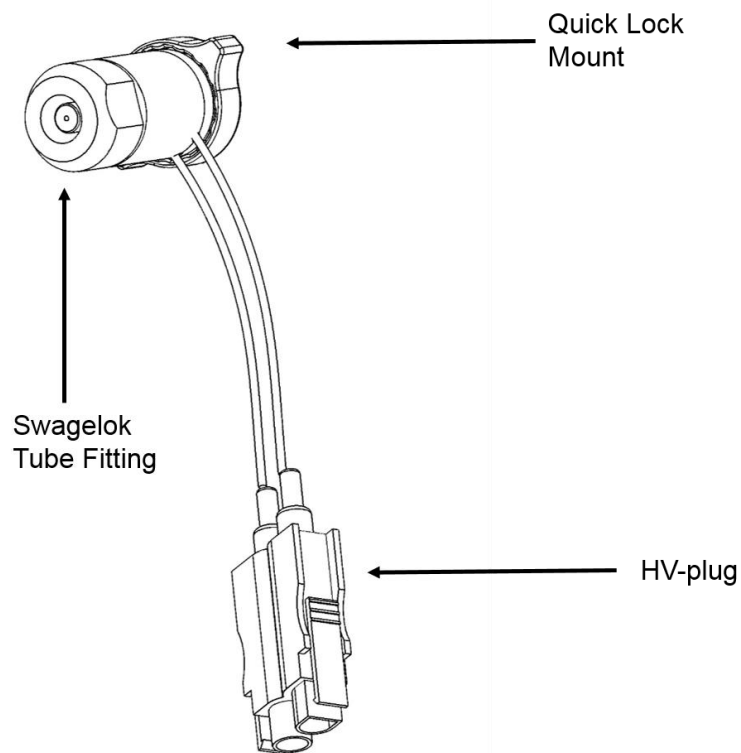
In the following section, the coupling of the SICRIT® Ion source is described on example of a Thermo Fisher Orbitrap system.



*Figure 9: SICRIT® Ion source with HV-plug and quick lock for the MS interface connection. For sampling and module connection, the ion source features a Swagelok tube fitting.*

	<p>Attention!</p> <p>Some parts of the mass spectrometer interface can be very hot and cause burnings or injuries. Before performing the installation, let the system cool down, wear protective gear and refer to the instructions given in the respective MS manual.</p>
	<p>Attention!</p> <p>Plasmion GmbH is not liable for any damage caused by ignoring the MS manufacturer's instruction manual, or damages that can occur during improper manipulation of the MS interface.</p>

## 9.1 Installation preparation

Before mounting the SICRIT® Ion source to your MS, install your specific SICRIT® MS interface following the steps described in the interface installation manual.

- Put your MS-instrument in standby mode and let API inlet cool down.
- Replace the API ion source housing with the SICRIT® Interlock and install, where required, the ion source adapter (on example of Thermo API inlet: SICRIT® Transfer capillary).
- Check the vacuum of the first pumping stage in the status window of the MS software.

## 9.2 Mounting the SICRIT® Ion source

After installation of the SICRIT® Interlock and transfer capillary, you can now mount the SICRIT® Ion source by means of the quick lock mount (Fig. 10).

- Press the ion source onto the adapter
- Firmly hold the source and rotate the lock about ¼ turns clockwise, until you hear a “click” sound. This signalizes that the lock is engaged, and mounting is finished.

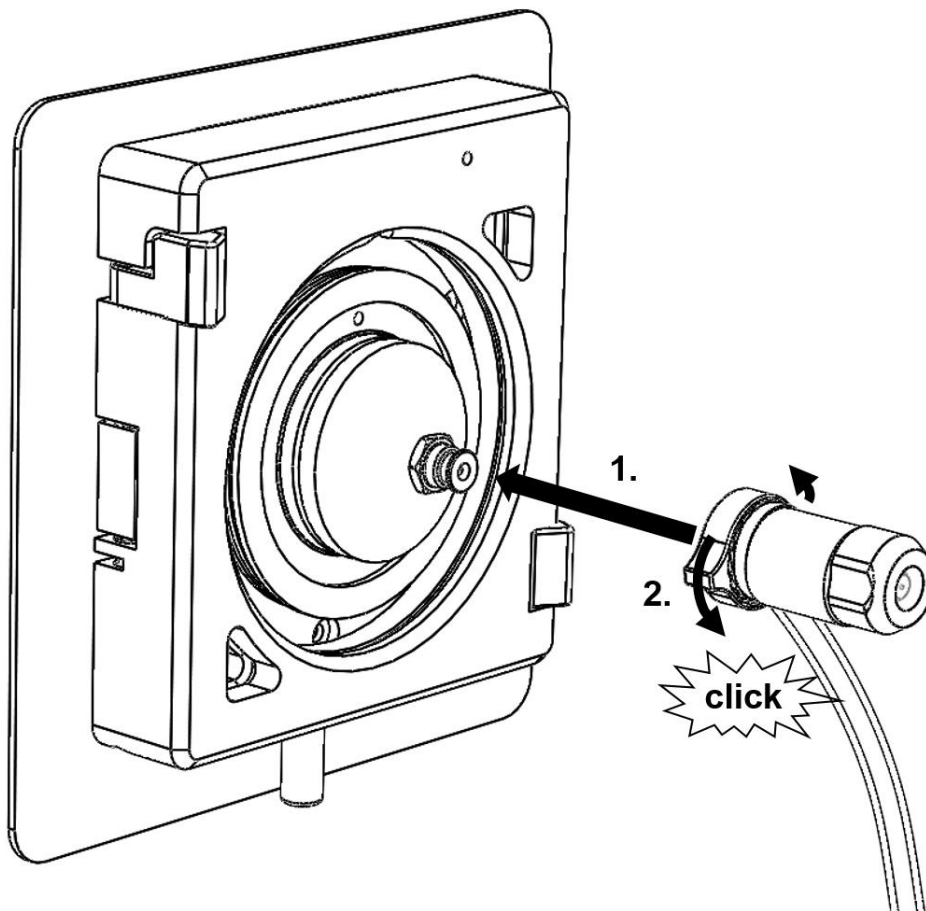

Figure 10: Mounting of the SICRIT® Ion source on the SICRIT® Transfer capillary.

	<p>On new sources the locking might require some force. The locking mechanism becomes easier after a few installations.</p>
	<p>The MS instrument software recognizes the SICRIT® Ion source as standard (nano)-ESI- source. Make sure that spray voltage is set to 0! Note that the maximum allowed API inlet temperature is 250 °C with a mounted SICRIT® Ion source. Make sure to control these settings, as you could damage the SICRIT® Ion source, or your MS.</p>

- After mounting the source, take the safety cap out of the interface mounting kit and place it over the source (Fig 11a) until you here a click. For details on the mounting procedure of the safety cap, please refer to the respective interface installation manual.

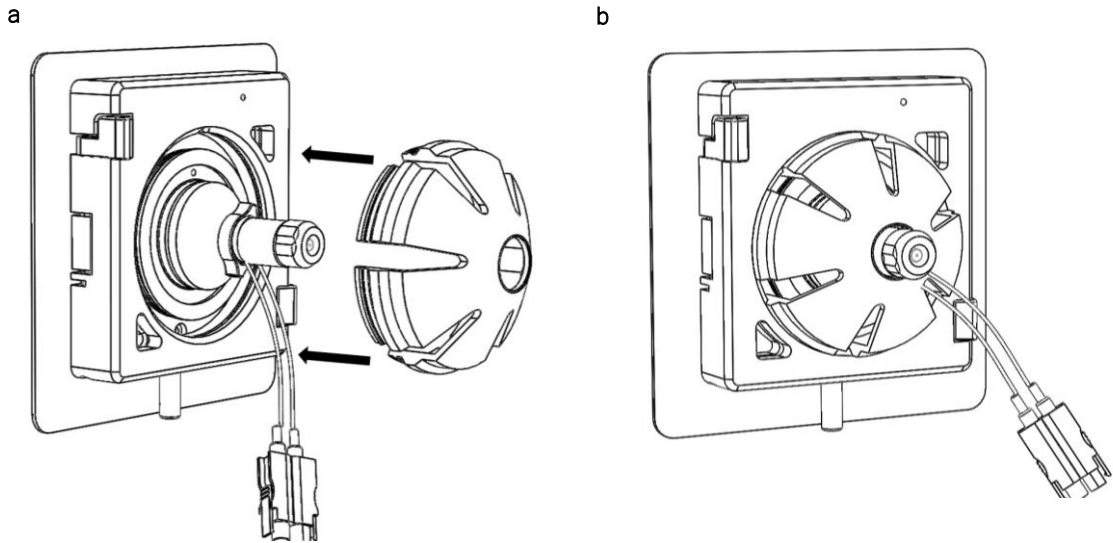

Figure 11: a) Mounting of the TX2 Safety cap, b) fully mounted TX2 interface and SICRIT Ion source.

- Connect the ion source with the control unit using the supplied cables (Fig 12). Make sure the control unit is turned off before plugging in the high voltage cables.

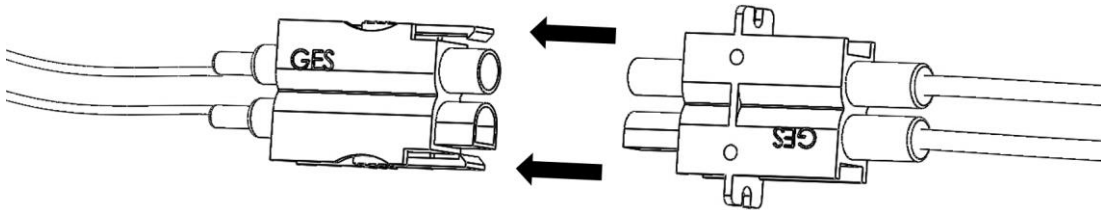

Figure 12: HV connector of the ion source cables and the HV cables of the control unit.



#### Attention!

Only use genuine cables supplied by the manufacturer. Avoid bending the cables (minimal bending radius is 4 cm). Do not place the cables over sharp edges or hot surfaces. Avoid strain on the cables and use strain relief measures.

To enable a flexible sample delivery, the ion source is equipped with a 6 mm gas tight Swagelok fitting. Make sure to minimize mechanical stress on the source during installation, in order to avoid damaging the source. If possible, use flexible tubing (e.g. PTFE) for sample delivery to decouple the source from mechanical tensions.

For coupling with SICRIT add-on modules please refer to the specific installation and coupling guides that are supplied with these devices.



## 10. Setup and Operation of the SICRIT® Ion Source

Please refer to the specific setup and operation notes of your control unit. Generally, the ionization, respectively the plasma, ignites at voltages above 1000 V. For best performance, the source should be operated at a voltage of about 200 – 500 V above the ignition voltage. The recommended maximum output voltage is 2000 V to avoid damages on the plasma core.

### Sampling

The SICRIT Ion source is designed for continuous sampling and online measurements. There is no specific requirement for the sampling atmosphere, except that high particle loads in the carrier gas stream might cause depositions or damages within the attached MS-system. When noble gases are used as atmosphere, the ignition voltage is drastically reduced! Also make sure to avoid highly corrosive gas atmospheres, since they might damage the ion source or the subsequent inlet system of your MS.

Ensure to choose a sampling setup that ensures “ambient” pressure at the inlet of the SICRIT Ion source, e.g. using a T-piece and an overflow.

	<p>Attention!</p> <p>To avoid damages to your MS System avoid overpressure on the SICRIT inlet!</p>
	<p>Attention!</p> <p>To minimize the chance of contaminations or damages to your MS system avoid high particle loads (e.g. aerosols) in the sample gas stream passing into the SICRIT source!</p>

To improve the ionization efficiency a gas humidifier should be installed in closed sampling systems (see Fig. 13). However, ensure that no droplets are transported into the source or that humidity exceeds the specified limits (s. data sheet).

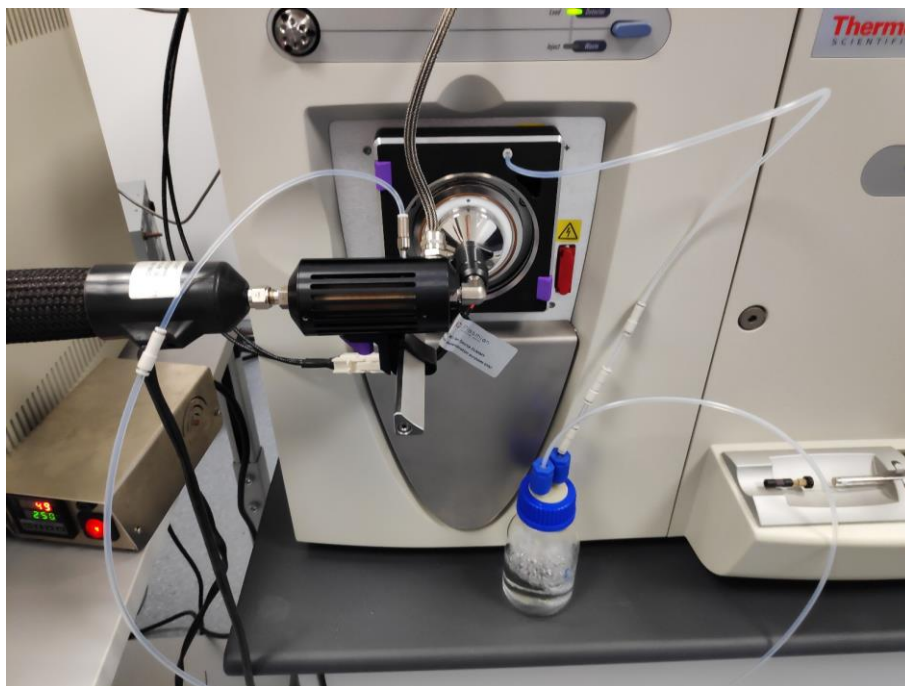

Figure 13: Setup for humidifying the carrier gas.



## 11. Service and Maintenance of the SICRIT® Ion Source

The operation of the plasma source causes slight consumption of the dielectric barrier material inside the plasma core. Therefore, the core has a limited lifetime and has to be replaced periodically. This is also necessary for the unlikely event that contaminations have been deposited in the source.

There is no predefined core exchange interval, since the lifetime depends on operation conditions, analyte matrix and temperature. If sensitivity drops or your total ion count (TIC) signals get instable, consider changing the core. A minimum lifetime of 1000 hours at 200 V above Plasma ignition voltage for standard operation conditions is guaranteed.

### Change of the Plasma core

	<p><b>Attention!</b></p> <p>Before any manipulation on the ion source switch off the control unit and disconnect the cables.</p>
---	--

The plasma core is build into the ion source. To exchange it, turn off the control unit, disconnect the cables and unmount the ion source from the MS, following the above mounting instructions in reverse order.

Use the supplied mounting tool to take the core out of the ion source (Fig. 14).

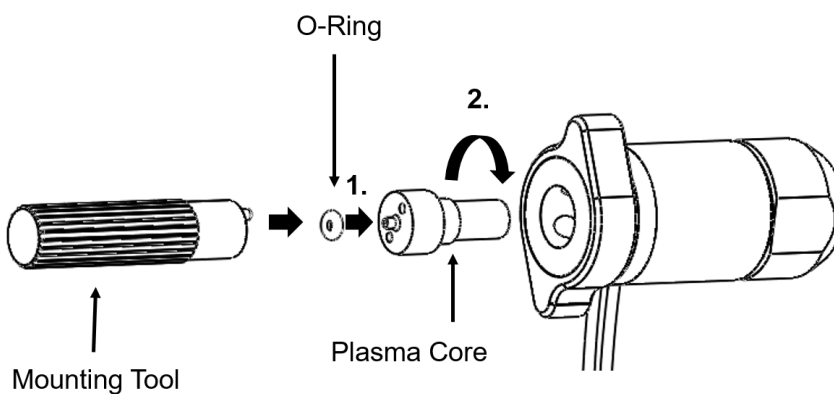

Figure 14: Changing the plasma core using the supplied tool.

- Place the bracket of the mounting tool in the sockets of the core.
- Unscrew the core counterclockwise from the ion source using the tool. If the core cannot be taken out easily, carefully hit a firm surface to loosen it and take it out.
- Check the sealing O-ring for damages or deformations and replace it if necessary.

- Put in the new core and mount it by screwing it in clockwise (only hand tight!) using the provided mounting tool.
- Make sure to not forget the O-ring.



Make sure the bracket of the mounting tool firmly fits the sockets of the core while screwing in and out.

Only tighten the core hand tight! Due to warming effects from the interface or sampling module, the connection might tighten later on.

## 12. Troubleshooting the SICRIT® Ion Source

In the following section common problems are discussed that might occur during operation of the system. If you do not feel confident to solve the problems after this brief troubleshooting guide, please contact the manufacturer for further advice. Turn off the device and separate it from the power grid, before performing any service action.



Please support us in the further development of the devices by sending us a short description of the error, its occurrence and/or the solution via email to [support@plasmion.de](mailto:support@plasmion.de) – we appreciate your efforts!

We are further happy to receive feedback on the handling or operation, since we are always eager to improve our customer experience.

### 12.1 Problem: The TIC is Spiking unexpectedly

Error: Fast spiking TIC (vertical flanks) signals indicate water droplets have been drawn into the system that change the ionization efficiency drastically.

- Make sure the distance of the humidifier and the source is sufficient. If necessary, interate a small filter (e.g. paper).
- Make sure the temperature of the humidifier is lower than the gas temperature anywhere in the system to avoid condensation and subsequent droplet formation.

### 12.2 Problem: Instable MS signals

Error: Tuning problems.

- Ensure your systems ion optics are tuned adequately for the operation of the SICRIT® Ion source. For sole ambient atmosphere choose constant background signals (e.g. plasticizers) and tune the system for maximum signal or use the automatic total TIC tuning.
- Check if the set voltage is about 200 V above igniton voltage. Note: The ignition voltage may vary with changing gas phase temperature.

Error: The plasma is instable.

- Check if there is „ambient pressure“ on the SICRIT® Ion Source inlet. If the pressure or the flow rate gets too low the signal may get instable. If you require such low pressures for sampling, please contact the manufacturer for technical advice.

- Check the ion source and the inlet adapter for contamination or cloggings (e.g. large particles). Unmount the source following the mounting instructions in reverse order. Visibly inspect the source. You should be able to see directly through the source. If not, clean it with a thin (< 0.6 mm) piece of wire. Clean the SICRIT adapter (e.g. transfer capillary) following the instructions for the ion transfer capillary in the MS manual.
- Check if the inner electrode is contaminated, by taking out the core as described above. You should be able to see the inner electrode as a small pin inside the ion source. Use a small cotton swab with methanol and clean the inner electrode.
- Check if the plasma core of the ion source is worn out and the plasma ignition is instable. Replace the ion core as described above if necessary. An electrical shot between the electrodes may result in the error message *Low Voltage at HV-output detected*.

Error: There is a leak in the sampling system, which can be e.g. obvious by high background signals.

- Check if the connections are gas tight. Especially check that the quick lock connector of the source is fully engaged and that the inlet capillary is mounted properly.

## 13. Replacement and Spare Parts

<b>Description</b>	<b>Part No.</b>
SICRIT® Ion Source (complete)	03-01-01
Plasma core	03-01-04
SICRIT® Mounting tool	03-01-05
HV Cables (Ion Source  Control Unit)	02-03-01