

MIRA XTR DS



2.926.01XX

Product manual

8.0926.8005EN / 2021-09-15



Metrohm Raman
407 South 2nd Street
Laramie, WY 82070
USA
+1 307 460 2089
info@metrohm.com
www.metrohm.com

MIRA XTR DS

2.926.01XX

Firmware version 8.0.3.40 or higher

Product manual

8.0926.8005EN /
2021-09-15

Technical Communication
Metrohm Raman
Laramie, WY 82070

This documentation has been prepared with great care. However, errors can never be entirely ruled out. Please send comments regarding possible errors to the address above.

Copyright

This documentation is protected by copyright. All rights reserved.

Trademark notice

Android™ and Google Play™ are trademarks of Google LLC in the United States and/or other countries.

Bluetooth® is a registered trademark of Bluetooth SIG, Inc.

HazMasterG3® is a registered trademark of Alluviam LLC.

Windows® is a registered trademark of Microsoft Corporation in the United States and other countries.

All other trademarks are the property of their respective owners.

Table of contents

1	Overview	1
1.1	Instrument description	1
1.2	Model versions	1
1.3	MIRA software	2
1.4	Third party software	2
1.5	About the documentation	3
1.6	Additional Information – Software tutorials	5
1.7	Accessories	5
2	Safety	6
2.1	Intended use	6
2.2	Responsibility of the operator	6
2.3	Personnel requirement	7
2.4	Safety instructions	7
2.4.1	Danger from electrical potential	7
2.4.2	Laser safety	7
2.4.3	Warning stickers on the instrument	9
2.4.4	Warning sticker on the autofocus stand-off attachment	11
2.5	Design of warning messages	11
2.6	Meaning of warning signs	12
3	Functional description	14
3.1	Overview of the instrument	14
4	Delivery and storage	16
4.1	Delivery	16
4.2	Packaging	16
4.3	Storage	16
5	Installation	17
5.1	Installing HazMasterG3 app for Android	17
5.2	Installing MIRA Cal M for Android	18
5.3	Energy supply	20
5.3.1	Energy supply with batteries	20
5.3.2	Energy supply with MIRA PowerPack	23
5.4	USB connection	29



5.5	Safe shutdown	29
6	Initial configuration	31
7	Operation and control	32
7.1	Smart Tips – Overview	32
7.2	Attaching Smart Tips	36
7.3	Acquiring data	52
7.4	Acquiring data with the iUA	60
7.5	Acquiring data with the AFSO	63
7.6	Settings	67
7.6.1	Operating Procedures menu	69
7.6.2	Calibrating the instrument	74
7.6.3	Viewing, enabling and disabling libraries	76
7.6.4	System Settings menu	76
7.7	Viewing and editing samples in the scan log	90
7.8	Safe shutdown	92
8	Maintenance	93
8.1	Cleaning the product surface	93
9	Disposal	95
10	Technical specifications	96
10.1	Ambient conditions	96
10.2	Interfaces	97
10.3	Energy Supply	97
10.4	Dimensions and materials	97
10.5	Operating specifications	98

1 Overview

1.1 Instrument description

Metrohm Instant Raman Analyzers (MIRA) are handheld, high-power Raman spectrometers designed for rapid, nondestructive identification of unknown chemical samples, both liquid and solid. Barely larger than a smartphone, MIRA spectrometers are the only handheld Raman spectrometers currently on the market with Orbital Raster Scan (ORS) technology.

1.2 Model versions

MIRA XTR DS instruments are available in the following versions:

Table 1 Model versions

2.926.0110	MIRA XTR DS Basic	Laser class 3B
	MIRA XTR DS Basic is a starter package that contains the basic components required for operating MIRA XTR DS.	
	Check Metrohm Website for included parts.	
2.926.0120	MIRA XTR DS Advanced	Laser class 3B
	MIRA XTR DS Advanced includes a wide range of attachments suitable for standard applications in the field of first responders, military and security officials.	
	Check Metrohm Website for included parts.	



NOTICE

To purchase additional *Accessories* (see *chapter 1.7, page 5*).

1.3 MIRA software

MIRA Cal DS software

In order to configure a MIRA DS or MIRA XTR DS instrument, the following software is needed:

Table 2 Model versions

6.06071.020	MIRA Cal DS USB Stick
-------------	-----------------------

To download the latest version of MIRA Cal DS software and firmware, click on the following link:

<https://www.metrohm.com/en/support-and-service/software-center/mira-cal/>

MIRA Cal M mobile app

MIRA Cal M allows the user to analyze, manage, or share samples acquired on MIRA DS or MIRA XTR DS instruments. MIRA Cal M mobile app can be installed on an Android™ device optionally (see "Installing MIRA Cal M for Android", page 18).

1.4 Third party software

HazMasterG3® software

HazMasterG3 is a CBRNE/IED and HME investigative tool for use in traditional incident response situations. It delivers insights and guidance for 167,000+ chemical agents (toxic industrial chemicals (TICs), toxic industrial materials (TIMs), chemical warfare agents (CWAs), precursors, trade names, etc.).

HazMasterG3 is compatible with MIRA DS and MIRA XTR DS sample data and can be installed on an Android or Windows® device optionally.

Table 3 Model versions

6.6071.640	HazMasterG3 Software
------------	----------------------

The HazMasterG3 software is optional. To purchase the HazMasterG3 software, click on the following link:

<https://www.metrohm.com/en-us/products-overview/66071640>

1.5 About the documentation



NOTICE

Please read through this documentation carefully before putting the product into operation.

The document contains important safety information and warnings which you must follow in order to ensure safe operation of the instrument. Metrohm is not responsible for damages and safety hazards that occur from using the instrument in a manner that is not specified in the user manual.

Symbols and conventions

The following icons and formatting may appear in this documentation:

(5-12)	Cross-reference to figure legend
	The first number refers to the figure number, the second to the product part in the figure.
1	Instruction step
	Carry out these steps in the sequence shown.
Method	Designations for names of parameters, menu items, tabs and dialog windows in the software.
File ► New	Menu or menu item
Work area / Properties	Menu paths in order to arrive at a particular position in the software.
[Next]	Button or key

Proprietary information statement

This manual contains the valuable proprietary information of Metrohm Raman, Inc. and its affiliates, including all designs and related material, and such information is disclosed in confidence. It is intended solely for the information and use of the persons operating and maintaining the equipment described herein. No part of this manual may be reproduced, copied, translated, incorporated in any other material, disclosed or transmitted in any form or by any means, whether electronic, mechanical, photocopying, recording, or otherwise to any other persons for any other purpose without the express written permission of Metrohm Raman, Inc. To obtain such permission, or to obtain additional copies of this manual, please contact Metrohm Raman, Inc.



Continuous improvements

To remain the leader of the industry, Metrohm Raman, Inc. has a policy of continuous improvement of its products. As such, all products, product specifications, data and operating instructions are subject to change without notice.

Liability disclaimer

Metrohm Raman, Inc. and its affiliates take steps to assure that their published specifications and manuals are correct. Nevertheless, errors do occur. Metrohm Raman, Inc. and its affiliates reserve the right to correct any such errors and disclaim all liability resulting therefrom. The equipment described in this manual is warranted in accordance with the terms of Metrohm Raman, Inc.'s warranty. However, actual performance of such equipment is dependent upon factors such as system configuration, customer data and operator control. Since implementation by customers of the equipment may vary, the suitability of specific equipment configurations and applications must be determined by the customer and is not warranted by Metrohm Raman, Inc. or its affiliates.

Export control statement

These items are controlled by the U.S. Government and authorized for export only to the country of ultimate destination for use by the ultimate consignee or end-user(s) identified on the invoice. They may not be resold, transferred, or otherwise disposed of, to any other country or to any person other than the authorized ultimate consignee or end-user(s), either in their original form or after being incorporated into other items, without first obtaining approval from the U.S. Government or as otherwise authorized by U.S. law and regulations.

No liability for certain damages

Metrohm Raman, Inc., its affiliates, and anyone else involved in the design, manufacture, or delivery of the accompanying product (including hardware and software) shall not be liable, under any circumstances, for any loss of profits or any special, incidental, consequential, exemplary, or punitive damages whatsoever (including, without limitation, damages resulting from cost of replacement, loss of use, loss of data, loss of royalties, loss of profits, loss of revenue, loss of business, loss of prospective economic advantage, or failure or delay in performance) arising out of the use of or inability to use such product, even if Metrohm Raman, Inc. or its affiliates have been notified of the possibility of such damages.

1.6 Additional Information – Software tutorials

Refer to the following manuals for information about the software:

- Tutorial MIRA Cal DS: 8.105.8069EN
- Tutorial MIRA Cal M: 8.0105.8023EN

Insert the product number into the search field on <https://www.metrohm.com> to find the manuals.

1.7 Accessories

Up-to-date information on the scope of delivery and on optional accessories can be found on the Metrohm website. Download this information as follows:

Downloading the accessories list

- 1 Go to <https://www.metrohm.com>.
- 2 Enter the article number of the product (e.g. **2.1001.0010**) into the search field.
The search result is displayed.
- 3 Click on the product.
Detailed information regarding the product is shown on various tabs.
- 4 On the **Included parts** tab, click the link to download the PDF.
The PDF file with the accessories data is loaded.



NOTICE

Metrohm recommends downloading the accessories list from the Internet and keeping it for reference purposes.



2 Safety

2.1 Intended use

Metrohm products are used for the analysis and handling of chemicals and other materials.

Usage therefore requires the user to have basic knowledge and experience in handling chemicals. Knowledge with respect to the application of the fire prevention measures prescribed for laboratories is also mandatory. Be sure to take proper safety precautions when working with chemicals

Adherence to this technical documentation and compliance with the maintenance specifications make up an important part of intended use.

Any utilization in excess of or deviating from the intended use is regarded as misuse.

Specifications regarding the operating values and limit values of individual products are contained in the "Technical specifications" section, if relevant.

Exceeding and/or not observing the mentioned limit values puts people and components at risk. The manufacturer assumes no liability for damage due to non-observance of these limit values.

The EU declaration of conformity loses its validity if modifications are carried out on the instruments and/or the components.

2.2 Responsibility of the operator

The operator must ensure that basic regulations on occupational safety and accident prevention in chemical laboratories are observed. The operator has the following responsibilities:

- Instruct personnel in the safe handling of the product.
- Train personnel in the use of the product according to the user documentation (e.g. install, operate, clean, eliminate faults).
- Train staff on basic occupational safety and accident prevention regulations.
- Provide personal protective equipment (e.g. protective glasses, gloves).
- Provide suitable tools and equipment to carry out the work safely.

The product may be used only when it is in perfect condition. The following measures are required to ensure the safe operation of the product:

- Check the condition of the product before use.
- Remedy defects and malfunctions immediately.
- Maintain and clean the product regularly.

2.3 Personnel requirement

Only qualified personnel may operate this product. A qualified person is a user who has thoroughly reviewed this document and has a comprehensive understanding of the operations of the instrument.

The instrument is used for the analysis of chemical compounds, some of which may be hazardous. The user must be capable of recognizing and avoiding possible dangers, and be aware of standards, laws and regulations governing the handling of such chemicals.

2.4 Safety instructions

2.4.1 Danger from electrical potential



WARNING

Electric shock from electrical potential

A considerable danger of injury exists in connection with touching live parts.

- Never open the housing of the instrument when the power cord is connected. You can not service or replace any parts inside the housing.
- Only personnel who have been issued Metrohm qualification may perform service and repair work on electric and electronic parts.
- The electrical safety of the instrument is ensured as part of the international standard IEC 61010.

2.4.2 Laser safety

Nominal ocular hazard distance (NOHD)

The following information refers to the nominal ocular hazard distance (NOHD) for MIRA DS and MIRA XTR DS instruments in accordance with EN 60825-1, "Safety of laser products", see "Operating specifications", page 98.



WARNING

Eye injury by laser radiation

Laser radiation can cause serious eye injuries.

- Follow the safety measures and instructions.
- Instruments must be used by trained personnel only.
- Instruments of the laser class 3B must be used in protected and labeled rooms only.
- When working with open laser beams (Smart Tips of the laser class 3B) appropriate protective glasses must be used, see chapter "Operating specifications" in the MIRA device manuals.
- Observe the nominal ocular hazard distance (NOHD).
- Follow the provisions of the IEC 60825-1 standard "Safety of laser products" and the regulations for the use of laser systems in your country.

You can purchase protective laser glasses (6.7560.010) from Metrohm AG *Accessories* (see chapter 1.7, page 5).

Laser classification depending on Smart Tips

Attached Smart Tip	Laser Class 1	Laser Class 3B
Right Angle Attachment		X
Universal Attachment		X
Intelligent Universal Attachment		X
Stand-off Attachment		X
Autofocus Stand-off Attachment		X
Contact Ball-Probe		X
Calibration Standard	X	
Vial Holder	X	
Tablet Holder	X	
Short Working Distance Attachment Lens (SWD)		X
Long Working Distance Attachment Lens (LWD)		X
Extra Long Working Distance Attachment Lens (XLWD)		X

Attached Smart Tip	Laser Class 1	Laser Class 3B
SERS Attachment		X

Tablet Holder, Vial Holder and Calibration Standard have an interlock mechanism for measurement. This mechanism prevents laser radiation from emerging. The laser stops immediately if:

- The lid of the Smart Tip is opened.
- The attached Smart Tip is disconnected from the instrument.



WARNING

Risk of injury by laser radiation

Serious eye injuries by laser radiation.

- SERS Attachment (6.07506.040) does not have an interlock mechanism. Laser light can emerge from the laser aperture when the door is open.
- Please use caution and ensure that the instrument is powered off before opening this door for decontamination.

See also

Operating specifications (chapter 10.5, page 98)

2.4.3 Warning stickers on the instrument

The instrument is equipped with laser warning stickers, which are explained below.

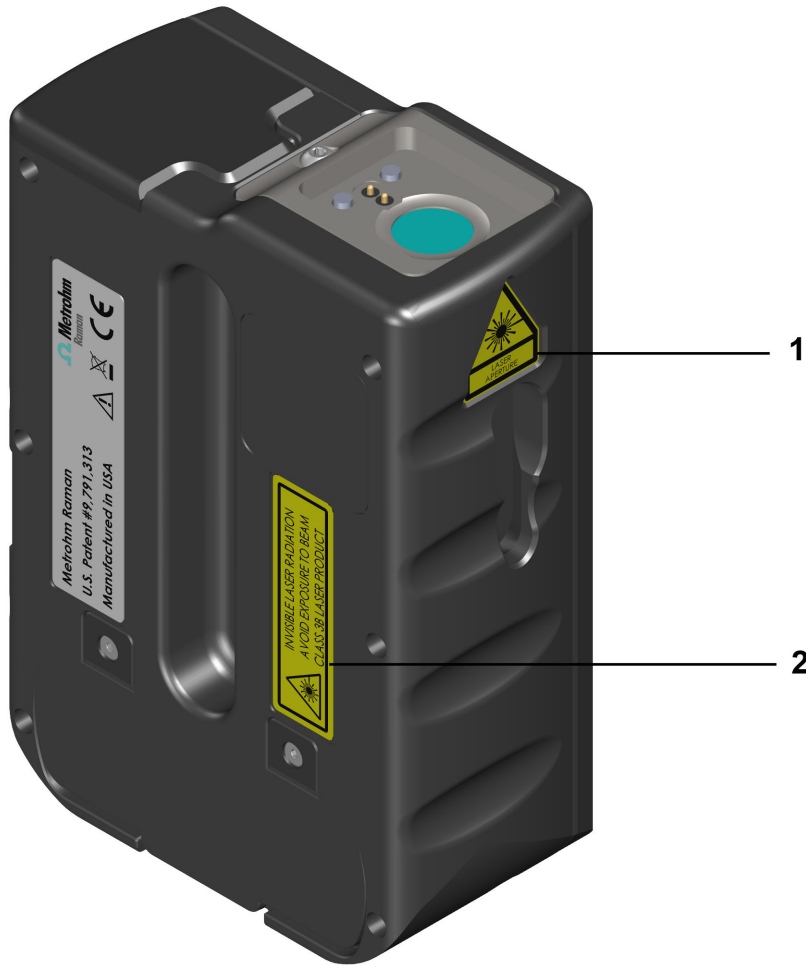

Figure 1 Warning stickers on the left side and rear of the instrument

1 Laser aperture sticker

Emergence of laser

2 Laser classification sticker

Laser classification of the instrument: laser class 3B

Invisible laser radiation

Avoid exposure to beam

Laser specifications

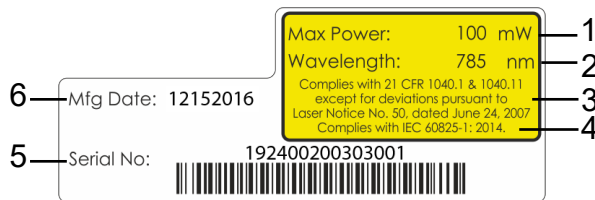

Figure 2 Sticker at the bottom of the instrument

1 Max Power: 100 mW

2 Wavelength: 785 nm

3 Complies with 21 CFR 1040.1 & 1040.11 except for deviations pursuant to Laser Notice No. 50, dated June 24, 2007

4 Complies with IEC 60825-1:2014

5 Serial number

6 Manufacturing date: month / day / year

2.4.4 Warning sticker on the autofocus stand-off attachment

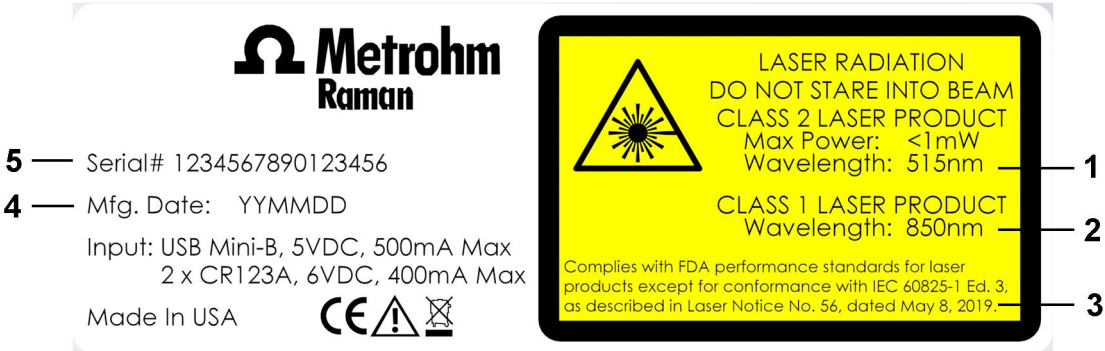

1 Wavelength: 515 nm Class 2

2 Wavelength: 850 nm Class 1

3 Compliance information
Complies with FDA performance standards for laser products except for deviations pursuant to Laser Notice No. 56, dated May 8, 2019.

4 Manufacturing date

5 Serial number

2.5 Design of warning messages

There are 4 hazard levels for warning messages. The following signal words are used for classifying the hazard levels in warning messages:

- **DANGER** indicates a hazardous situation which, if not avoided, will result in serious injury or death.
- **WARNING** indicates a hazardous situation which, if not avoided, could result in serious injury or death.
- **CAUTION** indicates a hazardous situation which, if not avoided, could result in minor or moderate injury.
- **NOTICE** indicates a hazardous situation which, if not avoided, could result in property damage.

Warning messages differ in design (color and warning sign) depending on the hazard level:



DANGER

Type and source of danger

Consequences when not observing the notice: An irreversible injury that may result in death is very probable.

- Measures to avoid the danger



WARNING

Type or source of danger

Consequences when not observing the notice: A serious injury that may result in death is probable.

- Measures to avoid the danger



CAUTION

Type or source of danger

Consequences when not observing the notice: A minor to moderate injury is probable.







- Measures to avoid the danger

2.6 Meaning of warning signs

This documentation uses the following warning signs:

Table 4 Warning sign according to ISO 7010

Warning sign	Meaning
	General warning sign
	Warning of electrical voltage
	Warning of hand injuries
	Warning of sharp object

Warning sign	Meaning
	Warning of hot surface
	Warning of biological hazard
	Warning of toxic materials
	Warning of flammable materials
	Warning of corrosive substances
	Warning of optical radiation
	Warning of laser beams

Depending on the intended use of the product, the corresponding warning sign stickers must be placed on the product.



3 Functional description

3.1 Overview of the instrument

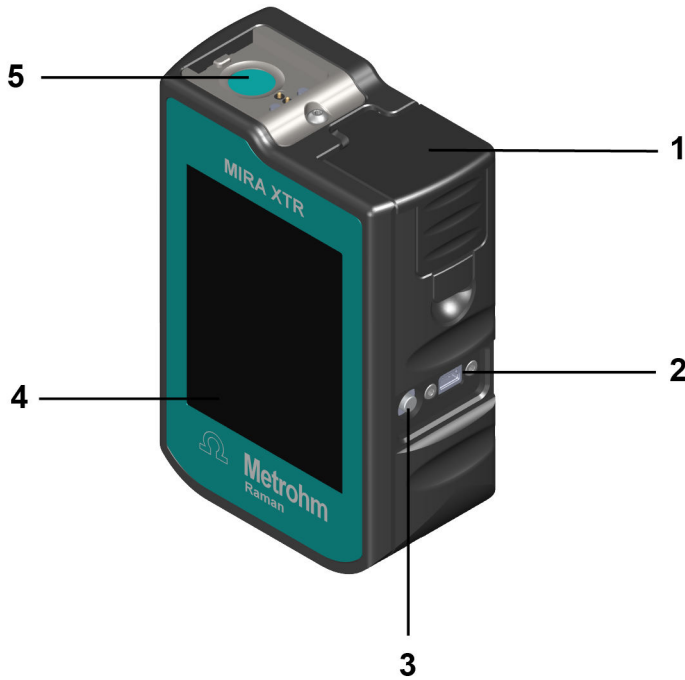

Figure 3 MIRA XTR DS – Front

1	Battery compartment	2	Type B mini USB connector
3	On/off switch	4	Touch screen
5	Magnetic smart tip fixture / laser aperture		



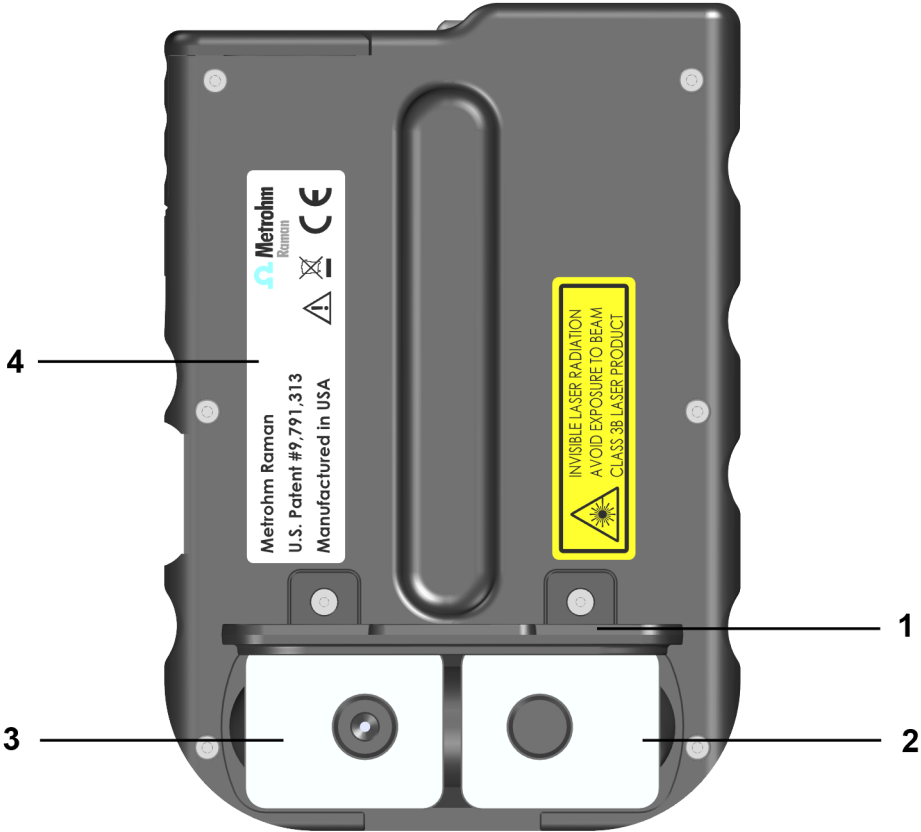

Figure 4 MIRA XTR DS – Rear

1 Accessories covering	2 Long Working Distance Attachment Lens (LWD) Storage
3 Short Working Distance Attachment Lens (SWD) Storage	4 Type plate

4 Delivery and storage

4.1 Delivery

Inspect the delivery immediately upon receipt:

- Check the delivery against the delivery note to ensure completeness.
- Check the product for damage.
- If the delivery is incomplete or damaged, contact your regional Metrohm representative.

4.2 Packaging

The product and accessories are supplied in protective special packaging. Keep this packaging to ensure safe transportation of the product. If a transport locking device is present, keep this as well for future reuse.

4.3 Storage



NOTICE

Always remove batteries if the instrument is not in use.

5 Installation

5.1 Installing HazMasterG3 app for Android

The installation of HazMasterG3 is optional (6.6071.640).

HazMasterG3 is a CBRNE/IED and HME investigative tool for use in traditional incident response situations. It delivers insights and guidance for 167,000+ chemical agents (toxic industrial chemicals (TICs), toxic industrial materials (TIMs), chemical warfare agents (CWAs), precursors, trade names, etc.).

Install app from USB flash drive

- 1** Plug the USB flash drive into the Android device. Use the adapter if necessary.
- 2** USB flash drive files may automatically open when plugged in. If they do not, navigate on the Android device to **Files**.
- 3** Look for the HazMasterG3 app. [InstallMe_1st.apk](#) Select the app.
- 4** You will be asked if you want to install. Click **Next ► Install**.
You may have to turn off the security on the phone to install the app.
- 5** A message will display that the app has been installed.
- 6** On the Android device, navigate to **Apps** and select **HazMaster**.
When prompted, grant the requested permissions.
Refer to the HazMasterG3 manual for help with the application.



5.2 Installing MIRA Cal M for Android

The installation of MIRA Cal M is optional.

With MIRA Cal M you can conveniently store, manage and exchange data acquired on a MIRA instrument. The app allows not only to activate or deactivate purchased libraries, but also to transfer data between the MIRA instrument and MIRA Cal M.

Getting the app on Google Play™

MIRA Cal M was developed for Android version 8.0 to 11.0.

- 1** On the Android device, open the Google Play Store app.
Alternatively, you can also go to play.google.com.
- 2** Select the white bar at the top of the page to bring up the keyboard.
Type: **MIRA Cal M**
- 3** Select the **MIRA Cal M** app.
- 4** Select **[Install]**.
- 5** Once download and installation are completed, open the **MIRA Cal M** app.
When prompted, grant the requested permissions.

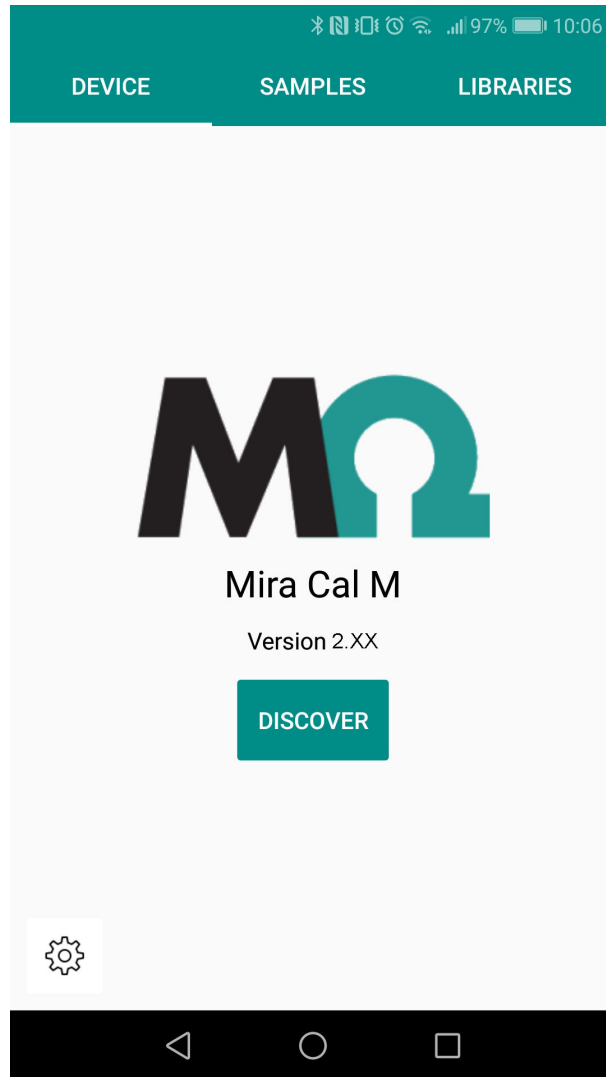

Figure 5 MIRA Cal M home screen



NOTICE

When MIRA Cal M is launched, libraries are downloaded in the background. For a successful download, the app has to be open and the Android device has to be connected to the internet. This process can take a few minutes.



5.3 Energy supply

5.3.1 Energy supply with batteries

Battery indicator	Charge status
	Full
	Almost full
	Half full
	Yellow battery warning We recommend to change the batteries when the battery indicator changes color from yellow to red.
	Red battery warning The instrument will give a low battery warning and then shut down.



NOTICE

Power save mode

You can configure a shutdown delay to save power (see "System Settings menu", page 76).

An optional MIRA PowerPack is available for up to 9 hours of operation (see "Energy supply with MIRA PowerPack", page 23).

Changing batteries

The instrument uses exchangeable or rechargeable batteries of type AA 1.5Vdc x 2.



NOTICE

Battery type recommendation

Use AA Energizer® Ultimate Lithium™ batteries. We also support rechargeable NiMH Panasonic eneloop pro™ batteries.

1



Pull the lever.



2



Open the top cover.
Exchange batteries. Refer to the plus and minus signs on the housing.

3



Close the top cover.

4



Push the top cover down until it latches closed.

5.3.2 Energy supply with MIRA PowerPack

The optional MIRA PowerPack is a Li-Ion battery pack. The MIRA PowerPack can be attached to power the instrument for up to 9 hours of operation.



NOTICE

During the operation with MIRA PowerPack, the shutdown delay is disabled. It's recommended to insert batteries in the instrument as a backup.



Figure 6 MIRA PowerPack – Front

1 Charge indicator

4 LED indicator lights show the state of charge.

2 Check button

The check button  lights up the charge indicator.

3 Lock button

The lock button is used for mounting the MIRA PowerPack on the instrument.

4 USB Mini-B plug

The USB Mini-B plug connects the MIRA PowerPack to the instrument.



Figure 7 MIRA PowerPack – Rear

1 USB-C connector

USB connector for charging the MIRA PowerPack.



NOTICE

Do not bend the cable.



Charging instructions

MIRA PowerPack is shipped at <25% charge, in accordance with IATA regulations. Please charge MIRA PowerPack fully before first use.

- 1 Plug the power charger to the power grid and connect the USB-C plug to the MIRA PowerPack USB-C connector.



The charge indicator will flash briefly while the MIRA PowerPack negotiates the charge voltage.

After a few seconds, the charge indicator will display the current state of charge.

Charging	
	0% - 25%
	25% - 50%
	50% - 75%
	75% - 100%
	100%
Red lights progressing 1 - 4	Charging paused due to temperature.



NOTICE

If no LED lights up after 30 minutes of charging, press for 10 seconds.

- As soon as the MIRA PowerPack is fully charged (all 4 LEDs are green), disconnect the charger from the power grid.

Installing the MIRA PowerPack

Remove the lanyard from the lanyard pins.



- Facing the front of MIRA DS and MIRA PowerPack, hook the MIRA PowerPack's right latch onto the instrument's right lanyard pin.
- Press and hold the lock button.
- Rotate the MIRA PowerPack's left latch onto the instrument's left lanyard pin.
- Release the lock button.







Connect the USB Mini-B plug to the instrument.

Checking the MIRA PowerPack state of charge

- 1 To check the state of charge, press the Check button .

The MIRA PowerPack charge indicator will light for approximately 3 seconds. 4 LED indicator lights show the state of charge.

MIRA PowerPack state of charge	
	75% - 100%
	50% - 75%
	25% - 50%
	<25%
	<5%, No output

5.4 USB connection



NOTICE

We do not recommend to use third party USB cables, only use the provided Metrohm USB Mini-B cable (order number 6.215.1110).

Energy supply

For stationary use in the laboratory, you can operate the instrument with the USB interface which is connected to a powered USB hub. The USB hub also allows data transfer.



NOTICE

Battery charging function

The instrument has no charging function for rechargeable batteries. You must replace drained batteries.

Synchronization

Connect the instrument to the Windows PC that uses the USB Mini-B cable.

If the instrument is off, connecting the USB cable to a Windows PC initiates an instrument start-up.

5.5 Safe shutdown



NOTICE

To prevent unexpected behavior in the instrument, always perform a safe shutdown.

A **safe shutdown** is performed in the following cases:

- The on/off switch is pressed.
- The battery is low.
- A battery-powered instrument is not in use for the duration specified in the shutdown delay.

An **unsafe shutdown** is performed in the following cases:



- The on/off switch is pressed and held for 3 seconds or longer.
- The battery door is opened while running on batteries only.
- The USB is unplugged while running on USB only.



6 Initial configuration



NOTICE

Configuration

Use MIRA Cal DS software to change instrument settings and to install spectral libraries.

Refer to MIRA Cal DS software tutorial for detailed information (see *"Additional Information – Software tutorials"*, page 5).



7 Operation and control

7.1 Smart Tips – Overview

Smart Tips are attached to the instrument with magnetic connectors. The Smart Tips contain a memory chip so that the instrument can identify them. Due to design, Smart Tips will not allow operation of the instrument when seated in an incorrect position.

The scope of delivery depends on the model version of the instrument (see "*Model versions*", page 1). You can purchase other attachments separately from Metrohm AG (see "*Accessories*", page 5). The following Smart Tips are available:

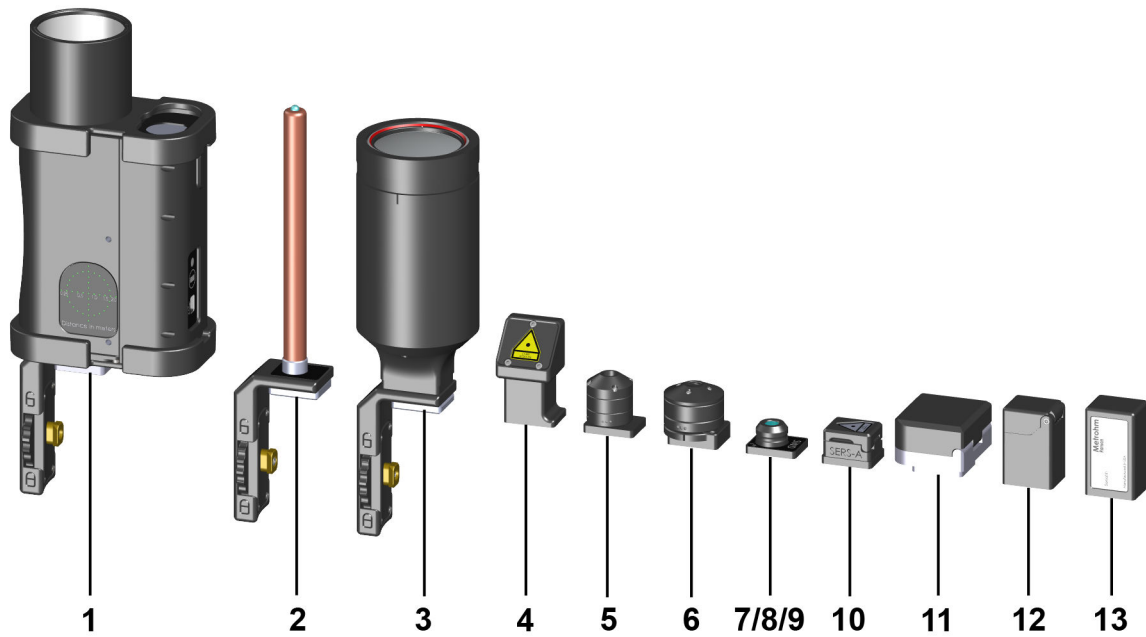

1 Autofocus Stand-off Attachment (6.07506.070)

The Autofocus Stand-off Attachment allows the collection of data from a distance of 0.3 m to 2.0 m.

The Autofocus Stand-off uses a class 2 green aiming laser to help target the sample. It then automatically obtains a range to the target and adjust the Raman collection lenses to obtain high quality data.

Perfect for mounting on a robot. The Autofocus Stand-off Attachment is not meant to be used outdoors. It is designed for use in low light situations. Class 3B laser operation.

2 Contact Ball-Probe (6.07506.030)

The Contact Ball-Probe allows to collect data from a substance with no concern of proper focus. Simply contact the substance with the probe to acquire the data.

The 6" (15.3 cm) stainless steel construction allows for easy cleaning.

The focal point on the probe is 400 microns from the tip of the lens. This means the probe will not perform well on substances through a bag. The probe is designed for direct contact of liquids and solids.

Sleeves are available to prevent contamination of the Contact Ball-Probe.

Class 3B laser operation.



3 Stand-off Attachment (6.07506.020)

The Stand-off Attachment allows to collect data from a distance of 0.25 m to 1.5 m.

The Stand-off Attachment can be used to identify the contents in a 55 gallon drum/barrel or scan a container from across the room.

The Stand-off Attachment is not meant to be used outdoors. It is designed for use in low light situations.

Class 3B laser operation.

5 Universal Attachment (6.07506.010)

The Universal Attachment is an attachment with 3 different sampling distances.

Use position 1 for focusing through bottles. The focal point is approximately **5 mm** from the end of the attachment.

Use position 2 for thin plastic bags. The focal point is approximately **3 mm** from the end of the attachment.

Use position 3 for direct contact. The focal point is approximately **1.0 mm** from the end of the attachment.

Class 3B laser operation.

7 Short Working Distance Attachment Lens (SWD) (6.07505.010)

A short distance lens for point and shoot measurement with class 3B laser operation.

The focal point is approximately **1.0 mm** from the top of the lens.

The SWD attachment lens is used for samples with direct contact or in thin plastic bags.

4 Right Angle Attachment (6.07506.000)

The Right Angle Attachment allows the collection of data by placing the substance on a surface and laying the MIRA DS down next to the substance with the Right Angle Attachment covering the substance.

Ideal for a baggie on the hood of a squad car.

Class 3B laser operation.

6 iUA – MIRA intelligent Universal Attachment (6.07506.060)

The iUA provides the flexibility of an universal attachment with the intelligence of the MIRA Smart Attachment feature.

Use position 1 for direct contact. The focal point is approximately **1.0 mm** from the end of the attachment.

Use position 2 for thin plastic bags. The focal point is approximately **4 mm** from the end of the attachment.

Use position 3 for focusing through bottles. The focal point is approximately **8 mm** from the end of the attachment.

In combination with the Content ID operating procedure, the iUA will display the container material and the internal contents in an easy to understand display.

Class 3B laser operation.

8 Long Working Distance Attachment Lens (LWD) (6.07505.000)

A long distance lens for point and shoot measurement with class 3B laser operation.

The focal point is approximately **8 mm** from the top of the lens.

The LWD attachment lens is used for samples in thick-walled bottles.

9 Extra Long Working Distance Attachment Lens (XLWD) (6.07505.020)

The extra long working distance attachment lens is used for point and shoot measurements.

The focal point is approximately **18 mm** from the top of the lens.

The XLWD attachment lens is used for samples in very thick containers as for example glass bottles.

Class 3B laser operation.

10 SERS Attachment (6.07506.040)

The SERS Attachment accommodates proprietary SERS substrates.

Class 3B laser operation.

11 Tablet Holder (6.07504.000)

The Tablet Holder is used for different tablet or capsule shapes. A spring-loaded holder helps to mount and position the sample.

Interlock mechanism allows measurement with class 1 laser operation. The laser stops if the housing is opened.

12 Vial Holder (6.07502.000)

The Vial Holder is used for samples in glass vials.

Interlock mechanism allows measurement with class 1 laser operation. The laser stops if the housing is opened.

13 Calibration Standard (6.07501.010)

The Calibration Standard is needed for the calibration of the instrument. The Calibration Standard contains an ASTM 1840 reference sample. The Calibration Standard is in the scope of delivery.



7.2 Attaching Smart Tips

Using Calibration Standard



Attach the Smart Tip by engaging the bottom left corner of the tip into the left edge of the mounting point. Rotate the tip into position.



Using Attachment Lenses



WARNING

Eye injury by laser radiation

Laser radiation can cause serious eye injuries.

- Follow the safety measures and instructions.
- Instruments must be used by trained personnel only.
- Instruments of the laser class 3B must be used in protected and labeled rooms only.
- When working with open laser beams (Smart Tips of the laser class 3B) appropriate protective glasses must be used, see chapter "Operating specifications" in the MIRA device manuals.
- Observe the nominal ocular hazard distance (NOHD).
- Follow the provisions of the IEC 60825-1 standard "Safety of laser products" and the regulations for the use of laser systems in your country.



Attach the Smart Tip by engaging the bottom left corner of the tip into the left edge of the mounting point. Rotate the tip into position.



Using Universal Attachment



WARNING

Eye injury by laser radiation

Laser radiation can cause serious eye injuries.

- Follow the safety measures and instructions.
- Instruments must be used by trained personnel only.
- Instruments of the laser class 3B must be used in protected and labeled rooms only.
- When working with open laser beams (Smart Tips of the laser class 3B) appropriate protective glasses must be used, see chapter "Operating specifications" in the MIRA device manuals.
- Observe the nominal ocular hazard distance (NOHD).
- Follow the provisions of the IEC 60825-1 standard "Safety of laser products" and the regulations for the use of laser systems in your country.



Attach the Smart Tip by engaging the bottom left corner of the tip into the left edge of the mounting point. Rotate the tip into position.



The Universal Attachment has 3 positions. Rotate the attachment to change the position.



The dots indicate the position of the Universal Attachment.

Using intelligent Universal Attachment**WARNING****Eye injury by laser radiation**

Laser radiation can cause serious eye injuries.

- Follow the safety measures and instructions.
- Instruments must be used by trained personnel only.
- Instruments of the laser class 3B must be used in protected and labeled rooms only.
- When working with open laser beams (Smart Tips of the laser class 3B) appropriate protective glasses must be used, see chapter "Operating specifications" in the MIRA device manuals.
- Observe the nominal ocular hazard distance (NOHD).
- Follow the provisions of the IEC 60825-1 standard "Safety of laser products" and the regulations for the use of laser systems in your country.



Attach the Smart Tip by engaging the bottom left corner of the tip into the left edge of the mounting point. Rotate the tip into position.



The intelligent Universal Attachment has 3 positions. Rotate the attachment to change the position.



The dots indicate the position of the intelligent Universal Attachment.

On screen messaging indicates each position use: 1 dot = Surface, 2 dots = Bag, 3 dots = Bottle.

Using Vial Holder

Closing the lid prevents laser radiation from emerging.

The lid contains a safety feature which cancels the measurement and stops the laser if you open the lid.



Attach the Smart Tip by engaging the bottom left corner of the tip into the left edge of the mounting point. Rotate the tip into position.



Open the Vial Holder and insert a vial to measure its contents.

Using Right Angle Attachment



WARNING

Eye injury by laser radiation

Laser radiation can cause serious eye injuries.

- Follow the safety measures and instructions.
- Instruments must be used by trained personnel only.
- Instruments of the laser class 3B must be used in protected and labeled rooms only.
- When working with open laser beams (Smart Tips of the laser class 3B) appropriate protective glasses must be used, see chapter "Operating specifications" in the MIRA device manuals.
- Observe the nominal ocular hazard distance (NOHD).
- Follow the provisions of the IEC 60825-1 standard "Safety of laser products" and the regulations for the use of laser systems in your country.



Attach the Smart Tip by engaging the bottom left corner of the tip into the left edge of the mounting point. Rotate the tip into position.

Using Contact Ball-Probe**WARNING****Eye injury by laser radiation**

Laser radiation can cause serious eye injuries.

- Follow the safety measures and instructions.
- Instruments must be used by trained personnel only.
- Instruments of the laser class 3B must be used in protected and labeled rooms only.
- When working with open laser beams (Smart Tips of the laser class 3B) appropriate protective glasses must be used, see chapter "Operating specifications" in the MIRA device manuals.
- Observe the nominal ocular hazard distance (NOHD).
- Follow the provisions of the IEC 60825-1 standard "Safety of laser products" and the regulations for the use of laser systems in your country.



Attach the Smart Tip.

Seat the brass knob into the recess on the left side of the instrument.



Tighten using the brass knob on the attachment. Do not over tighten.

Using Stand-off Attachment



WARNING

Eye injury by laser radiation

Laser radiation can cause serious eye injuries.

- Follow the safety measures and instructions.
- Instruments must be used by trained personnel only.
- Instruments of the laser class 3B must be used in protected and labeled rooms only.
- When working with open laser beams (Smart Tips of the laser class 3B) appropriate protective glasses must be used, see chapter "Operating specifications" in the MIRA device manuals.
- Observe the nominal ocular hazard distance (NOHD).
- Follow the provisions of the IEC 60825-1 standard "Safety of laser products" and the regulations for the use of laser systems in your country.



Attach the Smart Tip.

Seat the brass knob into the recess on the left side of the instrument.



Tighten using the brass knob on the attachment. Do not over tighten.





Manually adjust the adjustment ring to the desired Stand-off distance and acquire the data.



NOTICE

It is recommended to use a tripod when using the stand-off attachment.

Using Autofocus Stand-off Attachment



WARNING

Eye injury by laser radiation

Laser radiation can cause serious eye injuries.

- Follow the safety measures and instructions.
- Instruments must be used by trained personnel only.
- Instruments of the laser class 3B must be used in protected and labeled rooms only.
- When working with open laser beams (Smart Tips of the laser class 3B) appropriate protective glasses must be used, see chapter "Operating specifications" in the MIRA device manuals.
- Observe the nominal ocular hazard distance (NOHD).
- Follow the provisions of the IEC 60825-1 standard "Safety of laser products" and the regulations for the use of laser systems in your country.

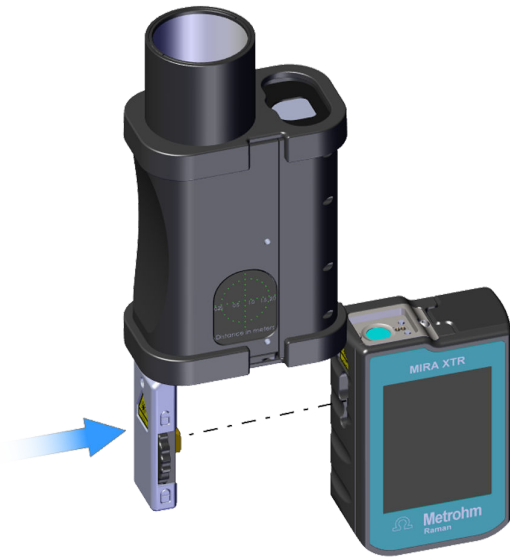

Attach the Smart Tip.

Seat the brass knob into the recess on the left side of the instrument.



Tighten using the brass knob on the attachment. Do not over tighten.



NOTICE

It is recommended to use a tripod when using the autofocus stand-off attachment.

Follow the on screen instruction to turn on the aiming laser and obtain a distance to the target.

Using SERS Attachment**WARNING****Eye injury by laser radiation**

Laser radiation can cause serious eye injuries.

- Follow the safety measures and instructions.
- Instruments must be used by trained personnel only.
- Instruments of the laser class 3B must be used in protected and labeled rooms only.
- When working with open laser beams (Smart Tips of the laser class 3B) appropriate protective glasses must be used, see chapter "Operating specifications" in the MIRA device manuals.
- Observe the nominal ocular hazard distance (NOHD).
- Follow the provisions of the IEC 60825-1 standard "Safety of laser products" and the regulations for the use of laser systems in your country.

**WARNING****Risk of injury by laser radiation**

Serious eye injuries by laser radiation.

- SERS Attachment (6.07506.040) does not have an interlock mechanism.
Laser light can emerge from the laser aperture when the door is open.
- Please use caution and ensure that the instrument is powered off before opening this door for decontamination.



Attach the Smart Tip.

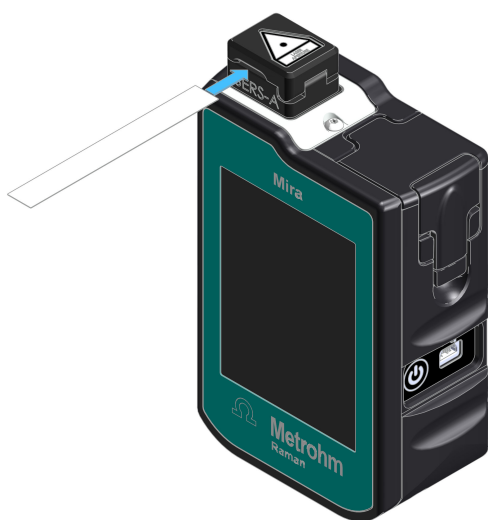

Slide the SERS paper substrate, **printed side down**, into the slot on the side of the attachment. Insert the strip until resistance is met. The attachment accommodates the strip at the optimal depth.





Remove the attachment from the instrument or power down the instrument.

Open the hinged door of the attachment.

Remove the strip.

Wipe down interior surfaces with a kimwipe or swab. Use ethanol or isopropanol to clean the attachment.



NOTICE

Cleaning is intended to remove residues from previous substrates, rather than for polishing the window.

Using Tablet Holder

Closing the lid prevents laser radiation from emerging.

The lid contains a safety feature which cancels the measurement and stops the laser if you open the lid.



Attach the Smart Tip by engaging the bottom left corner of the tip into the left edge of the mounting point. Rotate the tip into position.

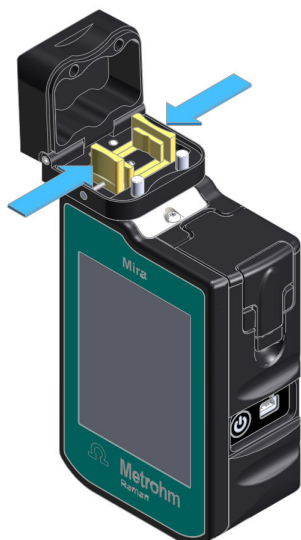

Open the Tablet Holder. Push the levers and position the sample in the middle.

Release the levers to fix the sample.

7.3 Acquiring data

The following steps show how to acquire spectra with the instrument.



NOTICE

Default pincode of the instrument is **1234**. Additional pin codes have to be defined and synchronized beforehand on MIRA Cal DS Software. User preferred operating procedures need to be created beforehand using instrument settings or MIRA Cal DS software.

Starting the instrument

Prerequisites:

The instrument is connected to the power supply or has battery power.

- 1 Switch on the instrument by using the on/off switch.

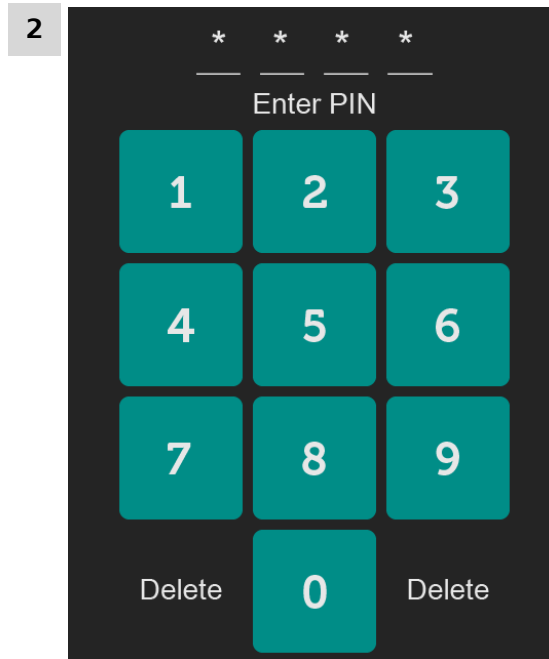

Enter **1234** (default pincode) or a user configured pin code.

After the PIN code is entered a prompt screen for calibration will appear.

- 3** To calibrate the system, select **[Calibrate Device]** (see "Calibrating the instrument", page 74).

To skip the calibration and move to the home screen, select **[Skip]**.

Acquiring Data

1 Attaching a smart tip

If not already done, attach the correct smart tip to the instrument (see "Attaching Smart Tips", page 36).

The display indicates:

- The attached smart tip (e.g. Universal)
None = No attachment found. The Arm Laser button is not active.
- **Laser Ready:** The laser is ready to be armed.

2 Changing the operating procedure

The display shows the current procedure, e.g.: **Default Procedure**

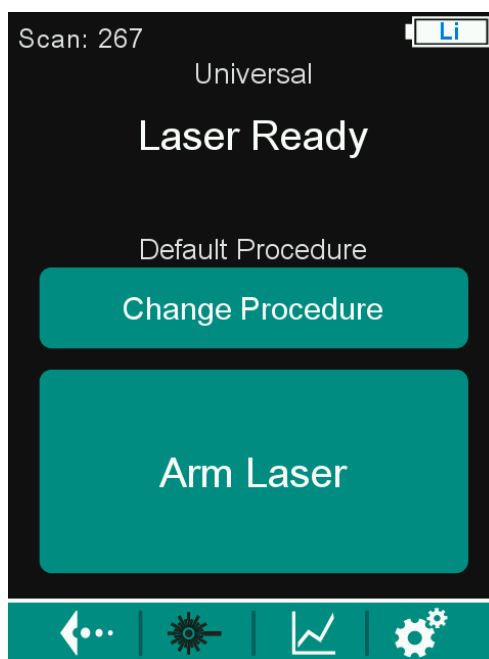

MIRA XTR DS is designed to be used with the default procedure. If one wishes to build and use a user procedure, be aware that this might affect the performance of the MIRA XTR DS matching algorithms. Select **[Change Procedure]** and select an operating procedure from the drop-down menu.



NOTICE

The **Default procedure** will match the scanned sample to all of the enabled libraries present on the instrument. The default procedure enables smart acquire to automatically adjust laser power and integration time.

The SERS Attachment automatically enables a specialized **SERS operating procedure**. The SERS operating procedure optimizes acquisition parameters and references specific SERS libraries.

The intelligent Universal Attachment (iUA) automatically enables the specialized **Content ID operating procedure**. The Content ID operating procedure optimizes the identification of contents in polymer or glass containers (*see "Acquiring data with the iUA", page 60*).

3 Arming the laser

Select **[Arm Laser]**.

The display indicates: **Laser Armed**

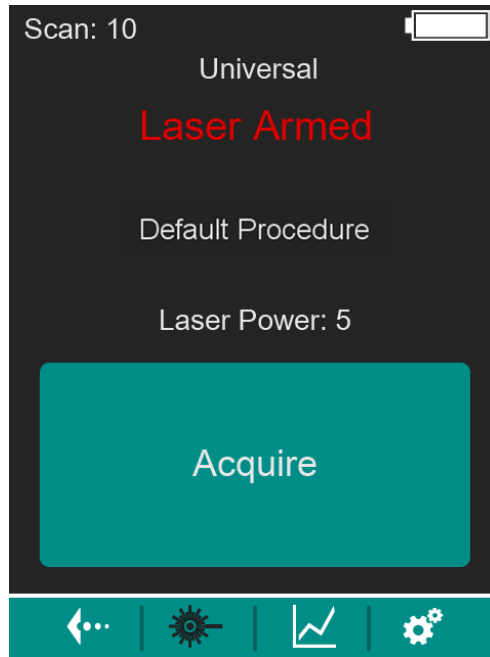

4 Measuring the sample

Start the measurement with **[Acquire]**.



The status screen will indicate the stage of the smart acquire. You can abort the acquisition only during the actual data collection. Once the matching starts, the process cannot be aborted.

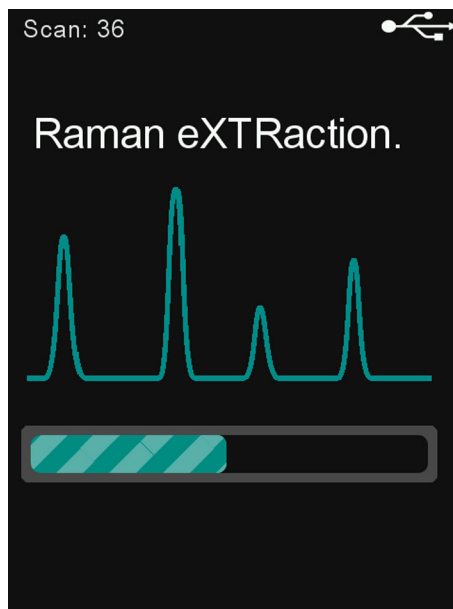
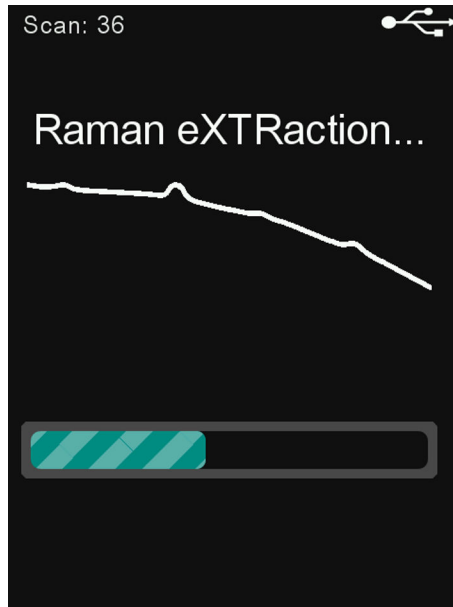

If MIRA XTR DS detects fluorescence, the **Raman eXTRaction** screen automatically appears. Once the extraction is complete the data will be matched to the enabled libraries.

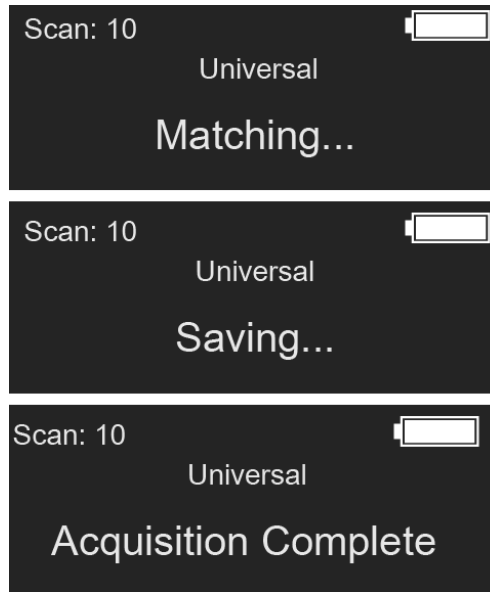

When the measurement is finished, the result appears as specified in the operating procedure.

5 Examining the result

The results are displayed in 2 tabs: **Mixture** and **Identification**. Select the different tabs to see the identification and mixture results. Note: Both tabs may be empty if no mixture or no identification is found.

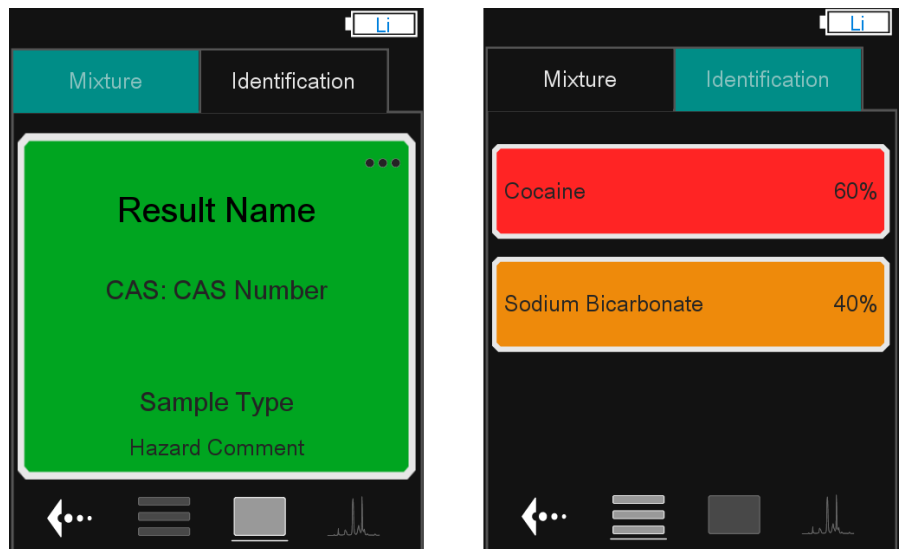

Select the three dots in the upper right corner to see GHS data or the HQI.

6 Measuring the next sample

Select **[Back]** button to return to the **Laser Ready** display.

Select **[Acquire]** to start the measurement.

Identification screens

Identification screen	Color code	Hazard level
	Green	Safe
	Orange	Caution
	Red	Danger
	Blue	No information
	Grey	Inconclusive For example, because of a low signal. Explore different techniques.

Identification screens for mixtures

Result list

If it is a mixture, the result list button shows a list of all components. To view the details of a component, select the respective component.

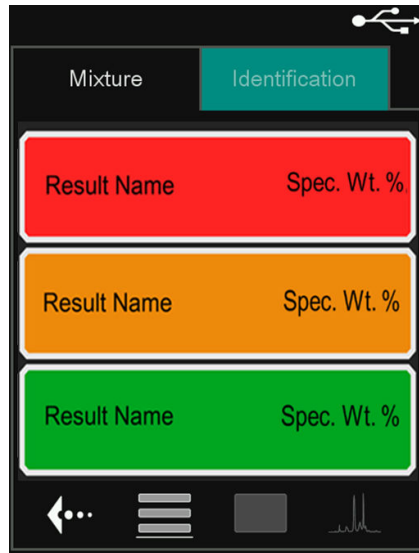

Result Name 

After acquisition is complete, the color coded Result Name screen is shown automatically.

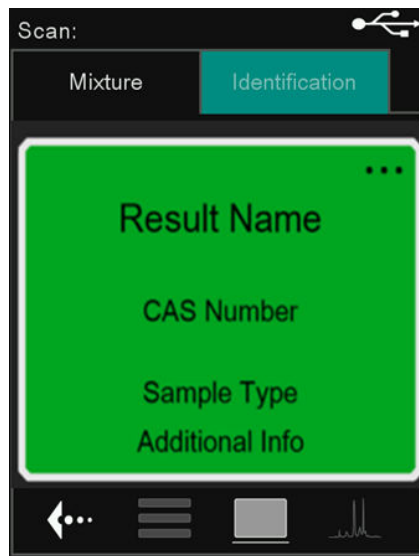

Spectrum 

The spectrum button shows the spectrum of the current sample. It will be overlaid with a spectrum from the library if available.

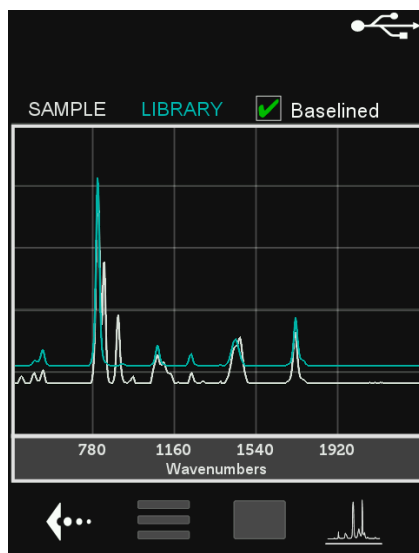

Select **SAMPLE** or **LIBRARY** above the spectral viewing window to hide the corresponding spectrum.

Activate **Baselined** to see the unprocessed raw spectrum.

7.4 Acquiring data with the iUA

The following steps show how to acquire spectra with the **intelligent Universal Attachment (iUA)**.

The intelligent Universal Attachment (iUA) automatically enables the specialized **Content ID operating procedure**. The Content ID operating procedure optimizes the identification of contents in polymer or glass containers. The Content ID operating procedure is only available on the instrument, not in MIRA Cal DS or in the mobile app.

With the iUA attached, rotate the iUA to the 3 different positions. The display shows the optimum use of the set position:

- 1 = Surface, focal point in approximately <1 mm distance
- 2 = Bag, focal point in approximately 4 mm distance
- 3 = Bottle, focal point in approximately 8 mm distance

1 Attaching the iUA

If not already done, attach the intelligent Universal Attachment (iUA) to the instrument (see "Attaching Smart Tips", page 36).

The display indicates:

- The attached iUA and its position, e.g. for position 1: **IUA-1**
- **Laser Ready**: The laser is ready to be armed.
- An instruction, e.g. **Rotate To IUA-3**

2 Changing the operating procedure

To optimize the identification of contents in polymer or glass containers, select **[Change Procedure]** and load the **Content ID operating procedure**.



NOTICE

In the following instructions we assume that the **Content ID operating procedure** is loaded.

3 Follow the instruction on the display, e.g. **Rotate To IUA-3**: Rotate the iUA to position 3.

The display shows the set position, e.g.: **IUA-3**.

4 Arming the laser

Select **[Arm Laser]**.

The display indicates: **Laser Armed**

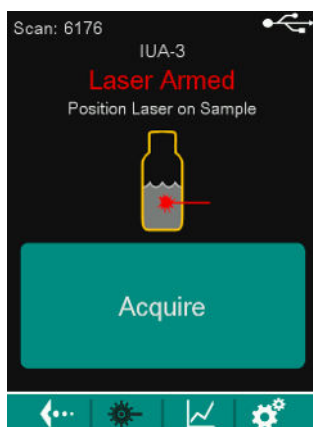

5 Measuring the sample

Follow the instruction on the display, e.g. **Position Laser on Sample**.

Start the measurement with **[Acquire]**.

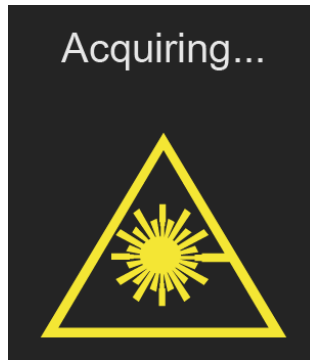

When the sample measurement is finished, the instrument is ready for the container measurement.

6 Measuring the container

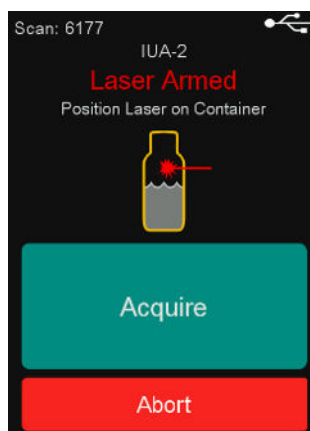

Follow the instruction on the display, e.g. **Position Laser on Container**.

Start the measurement with **[Acquire]**.



When the measurement is finished, the result appears as specified in the operating procedure.

7 Examining the result

The results are displayed in 2 tabs: **Contents** and **Container**. Select the different tabs to see the respective result.

Contents result

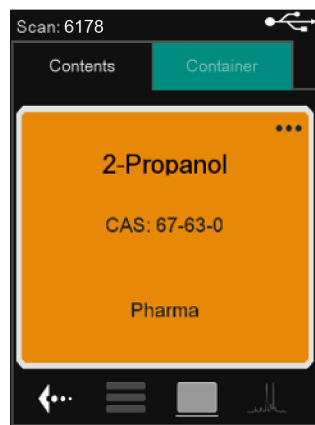

Container result

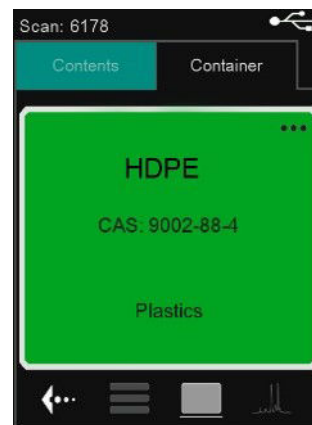

Select the three dots in the upper right corner to see GHS data or the HQL.

8 Measuring the next sample

Select the **[Back]** button to return to the **Laser Ready** display.

To start the measurement, follow the instruction on the display.

7.5 Acquiring data with the AFSO

The following steps show how to acquire spectra with the Autofocus Stand-off Attachment (AFSO).

1 Attaching the AFSO

Attach the Autofocus Stand-off to the instrument (*see "Attaching Smart Tips", page 36*).

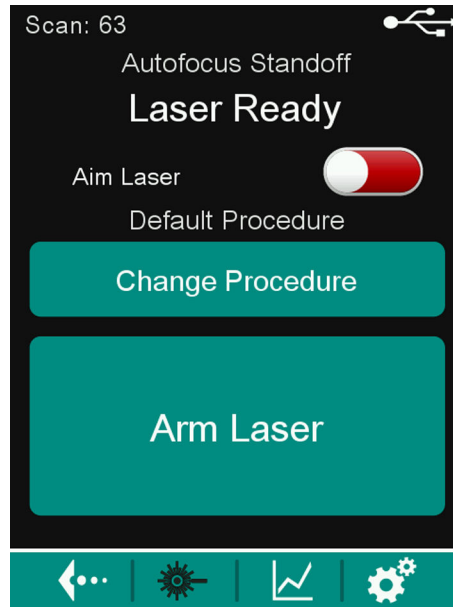

- The **[Aim Laser]** toggle automatically appears on the top of the **Arm Laser** screen.
- The selected operating procedure appears and can be changed by the **[Change Procedure]** button.
- The laser is ready to be armed.

2 Arming the laser

- Toggle the aiming laser on or off.
- Select **[Arm Laser]**.

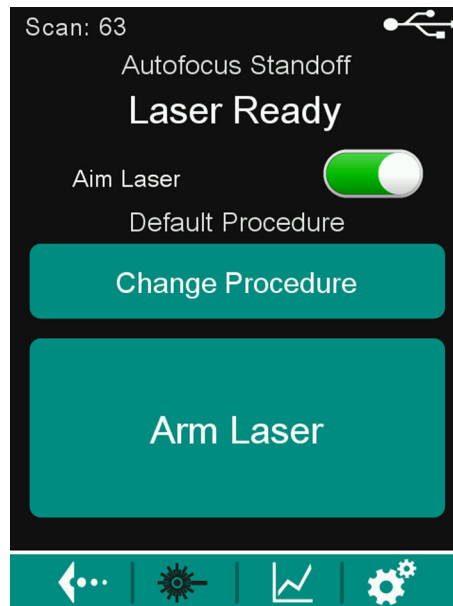

- **[Aim Laser]** on: A class 2 green aiming laser helps to target the sample.
- **[Aim Laser]** off: The aiming laser is shut off.



NOTICE

The aiming laser is a 514 nm Class 2 laser.

The device will automatically obtain a distance to the target and report it in the **Acquire** screen.

3 Entering the distance manually

To enter the distance manually, select the distance window by pressing on the **Distance** display box. Enter the distance and select **[Next]**.

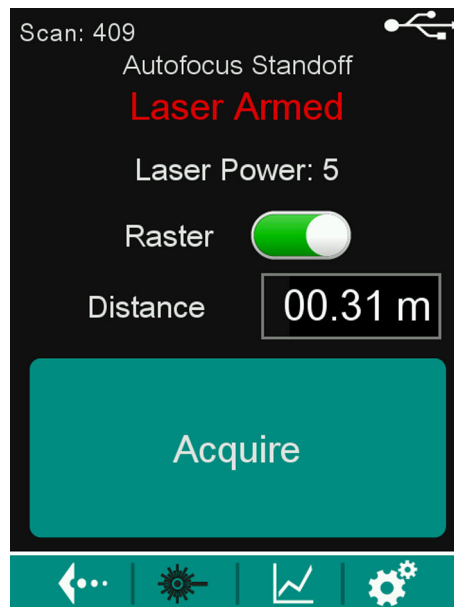

NOTICE

The range of the autofocus is 0.3 to 2.0 meters. In manual mode you cannot input numbers outside of this range. For best results, keep the distance to the sample between 0.3 and 0.40 meters.

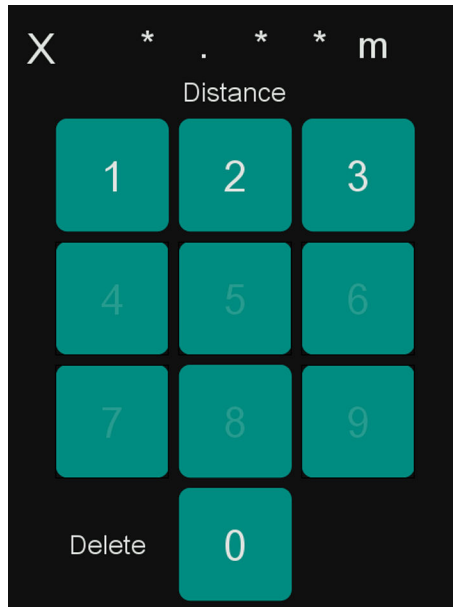

4 Measuring the sample

Start the measurement with **[Acquire]**.

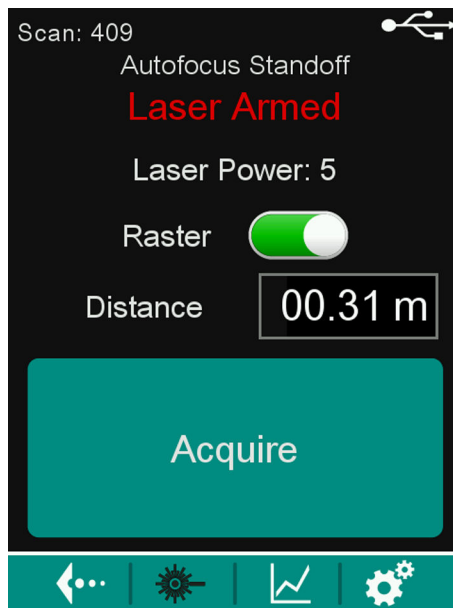

5 Examining the result

See "Acquiring data", page 52.

7.6 Settings





Brightness setting

- 1 Swipe the upper edge of the screen down.
- 2 Adjust the brightness in the popping down window.
- 3 Swipe up to close the brightness adjustment tool.

Menubar



In the Menubar, you can access several sections.

- Back to previous screen 
- Home screen / Arm laser 
- Scan log 
- Settings 

Open settings

- 1 Select .

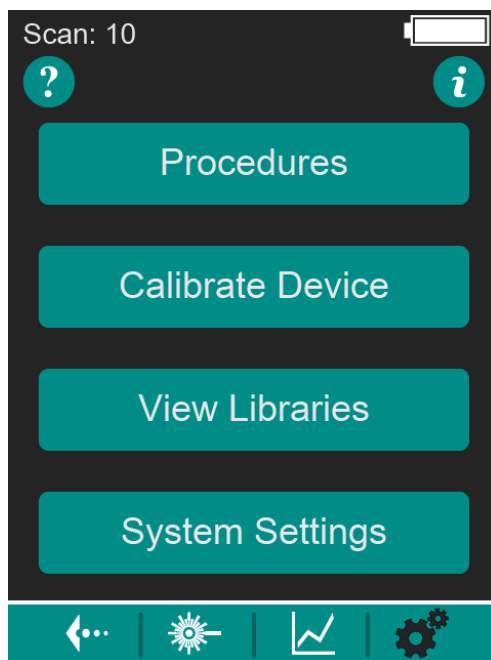



Figure 8 Settings menu

The menu offers the following settings.

- **[Procedures]:** see "Operating Procedures menu", page 69
- **[Calibrate Device]:** see "Calibrating the instrument", page 74
- **[View Libraries]:** see "Viewing, enabling and disabling libraries", page 76
- **[System Settings]:** see "System Settings menu", page 76

2 Info screen

To view the info screen, select .

The shown information includes:

- Time: HH:MM:SS UTC
- Date: YYYY-MM-DD
- Device Name
- Serial #
- Device Model
- PKG Version
- Language PKG
- Range: 400–2300 cm⁻¹
- Wavelength: 785 nm
- Cal Date: YYYY-MM-DD HH:MM:SS UTC
- Disc Space
- Temperature
- Voltage
- Board Rev

- FCC ID
- MAC ID

7.6.1 Operating Procedures menu

The **Operating Procedures** menu opens with , then **Procedures**

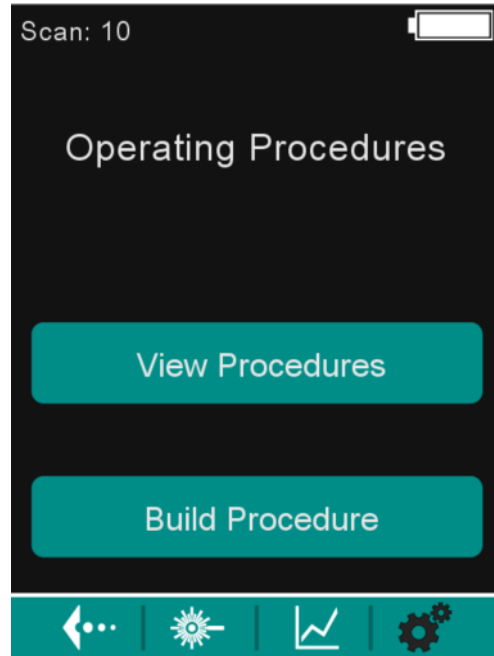

Figure 9 Operating Procedures menu

The menu offers the following options.

- **[View Procedures]** and their parameters, delete procedures: see "Viewing or deleting operating procedures", page 69
- **[Build Procedure]**: see "Building operating procedure", page 70

Viewing or deleting operating procedures

1

Select , then **Procedures ► View Procedures**.

The instrument displays the stored operating procedures.





2 To view the procedure settings, select the name of the corresponding procedure.

3 To delete a procedure, select . Confirm with **[Delete]**.

Building operating procedure



NOTICE

Procedures created on the instrument cannot be edited on the instrument or in MIRA Cal DS.

1 Select , then **Procedures ► Build Procedure**.

2 Naming procedure

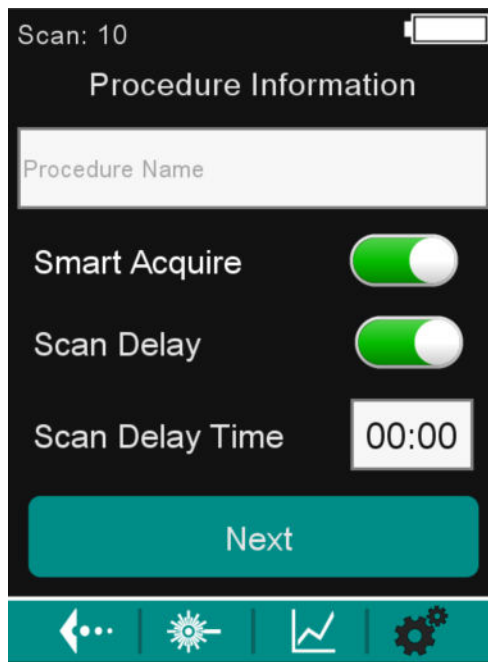

The procedure must be named. Select the Procedure Name input field. Enter the name on the keyboard. Confirm with **[Enter]**.

3 Scan Delay

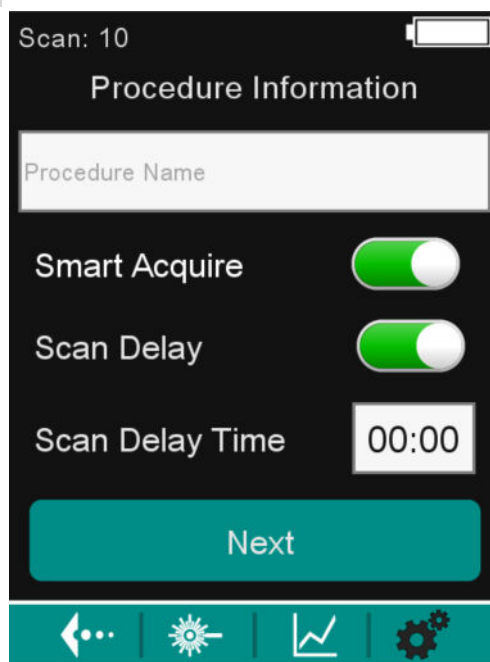

To set a delay before the start of a scan, enable **Scan Delay** and set the scan delay time.

4 Smart Acquire

Either enable or disable Smart Acquire.

- **Enabling Smart Acquire**



Enabling **Smart Acquire** on a custom operating procedure will run samples through the smart acquire noise and fluorescence rejection routines before matching against the enabled libraries.

- **Disabling Smart Acquire**

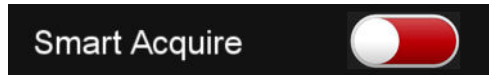

Select **[Next]**.

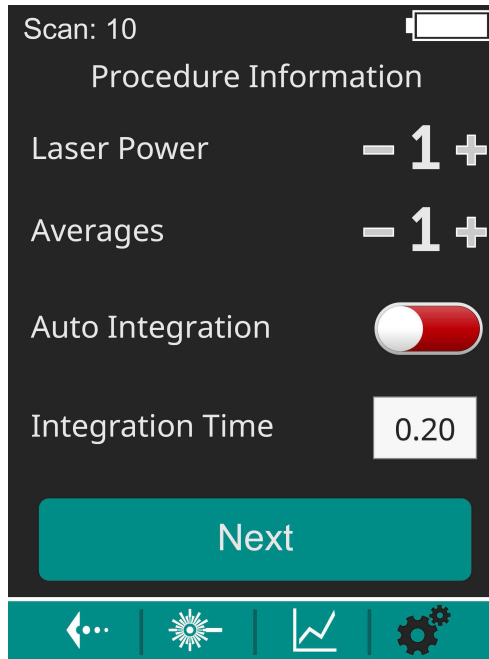

Define the **Laser Power** (1 - 5) and the number of **Averages**.
Activate **Auto Integration**, or deactivate **Auto Integration** and set an **Integration Time**.

Select **[Next]**.

5 Processing XTR

Select the **[Select Mode]** button.

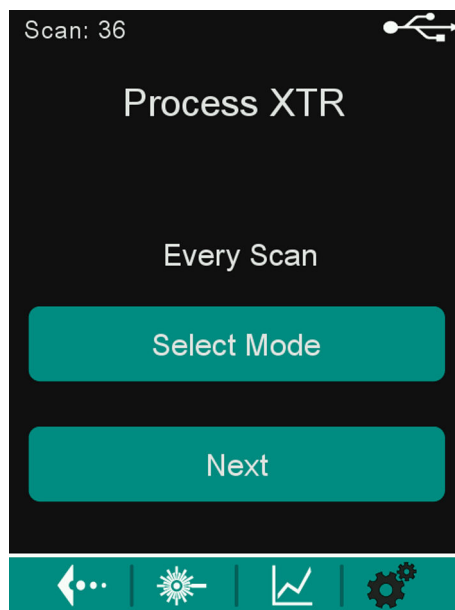

Choose the XTR Mode and select **[Next]**.

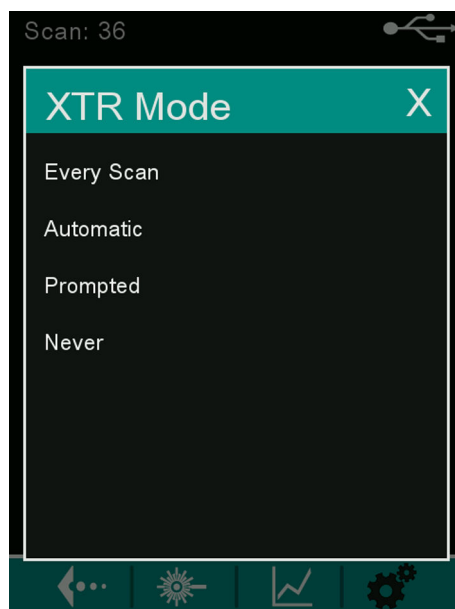

- **[Every Scan]** will always process the data using XTR algorithm regardless if fluorescence is detected or not.
- **[Automatic]** will automatically process the data using XTR algorithm when fluorescence is detected.
- **[Prompted]** prompts the user if fluorescence is detected.
- **[Never]** will never process the data using XTR algorithm.

6 Matching libraries

Matching will be performed against the enabled libraries.



NOTICE

If no libraries are enabled, it will always give an inconclusive result.

7 Saving procedure

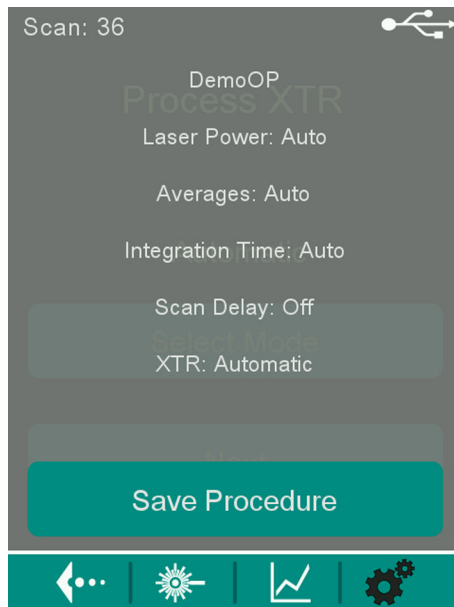

Review the procedure settings and select **[Save Procedure]**.

7.6.2 Calibrating the instrument



NOTICE

Instrument calibration can also be done in MIRA Cal DS software with a connected instrument.

- 1 Attach a Metrohm provided Calibration Standard (see "Attaching Smart Tips", page 36).

Place the instrument upright.

- 2



Select , then **[Calibrate Device]**.

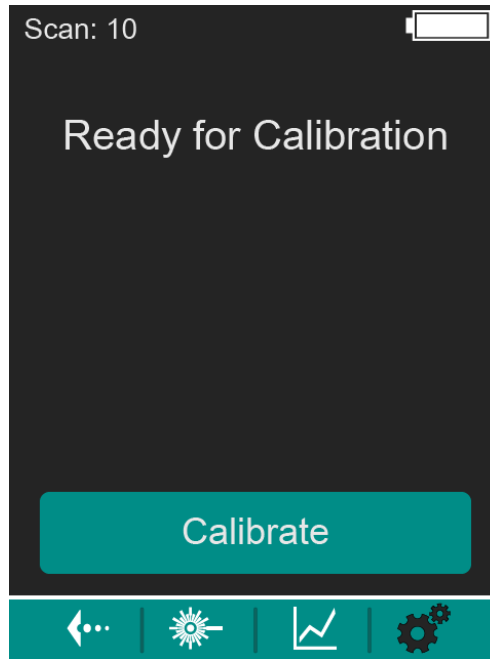

3 With the Calibration Standard attached and the instrument placed upright, select **[Calibrate]**.

4 Ensure that the calibration is successful.

Once the calibration is complete, a screen with the system suitability test will indicate if the system passed or failed.

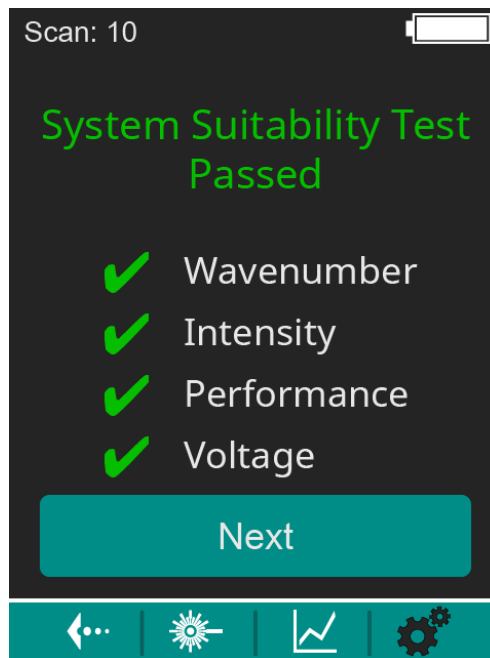

5 Select **[Next]**.

The home screen appears.

7.6.3 Viewing, enabling and disabling libraries

- 1 Select , then **[View Libraries]**.

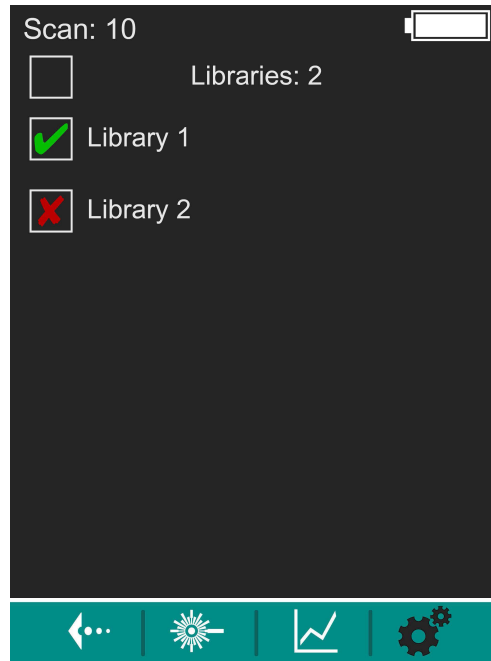

Figure 10 View Libraries screen

The instrument shows the installed libraries.

- 2 Enable or disable the libraries for matching.
- 3 To add libraries to the instrument, use the MIRA Cal DS Software.

7.6.4 System Settings menu

- Select , then **[System Settings]**.

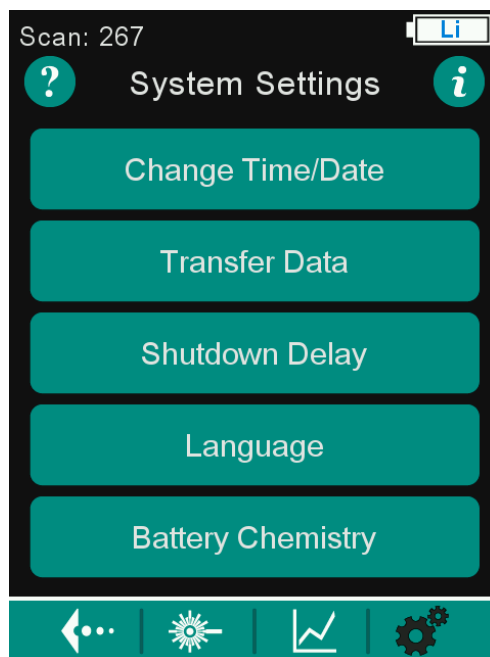



Figure 11 System Settings menu

The menu offers the following system settings:

- **[Change Time/Date]:** see "Change Time and Date", page 77
- **[Transfer Data]:** see "Transfer Data: Mount the instrument as Storage Device", page 77, see "Transfer Data: Bluetooth ® wireless technology", page 79
- **[Shutdown Delay]:** see "Shutdown Delay", page 86
- **[Language]:** see "Language", page 87
- **[Battery Chemistry]:** see "Battery Chemistry", page 88

Change Time and Date

- 1  Select , then **System Settings ► Change Time/Date**.
- 2 Adjust the time. Select **[Next]**.
- 3 Adjust the date. Select **[Save]**.

Transfer Data: Mount the instrument as Storage Device

Spectral data can be transferred to the Windows PC using **Mount as Storage Device** mode.

- 1  Select , then **System Settings ► Transfer Data**.

- 2 Plug in the instrument to a Windows PC using the provided USB cable.

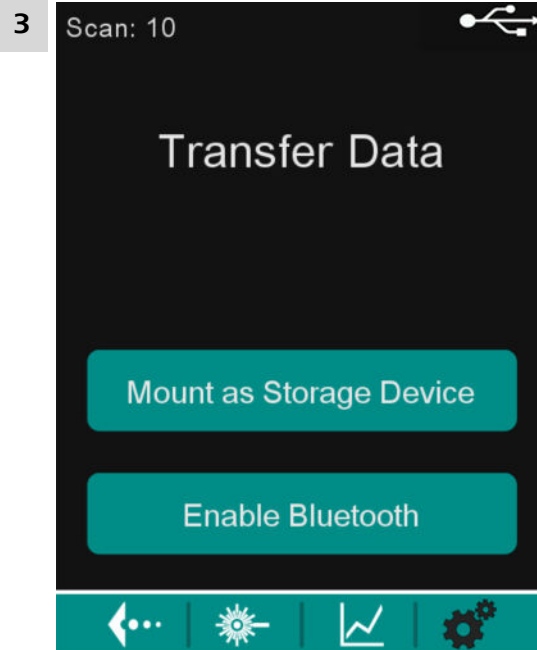

Select **[Mount as Storage Device]**.

The instrument will undergo a setup to install device drivers onto the Windows PC.



NOTICE

When connecting to a PC, a window pops up asking if you want to **[Scan and Fix]** or **[Continue without Scanning]**. Select **[Continue without Scanning]** to avoid issues with the device, the software and/or the PC.

- USER (F:)
 - hazmaster
 - scannumber
 - screenShots

The instrument will show up on the Windows PC as a storage device. i.e. User (E) above.

4 Importing sample files into MIRA Cal DS

For example, you can import sample files into MIRA Cal DS:

- Open MIRA Cal DS.
- Select **[Advanced]**.
- Select **File ► Open ► Samples**.
- Navigate to the mounted Android device. Open **scannumber**.
- Select one or more ***.rmb** files. Select **[Open]**.

The sample files are now in the MIRA Cal DS database.

5 Copying files to the Windows PC

Files in the scannumber folder can be copied directly to the Windows PC for later viewing or sharing.

6 To disconnect, select **[Disconnect Storage Device]**.

Transfer Data: Bluetooth® wireless technology

Spectral data can be transferred to an Android device via Bluetooth® wireless technology. The instrument needs to be within 10 m of the Android device, either tablet or cell phone.

1 Enabling Bluetooth on the instrument

Select , then **System Settings ► Transfer Data**.

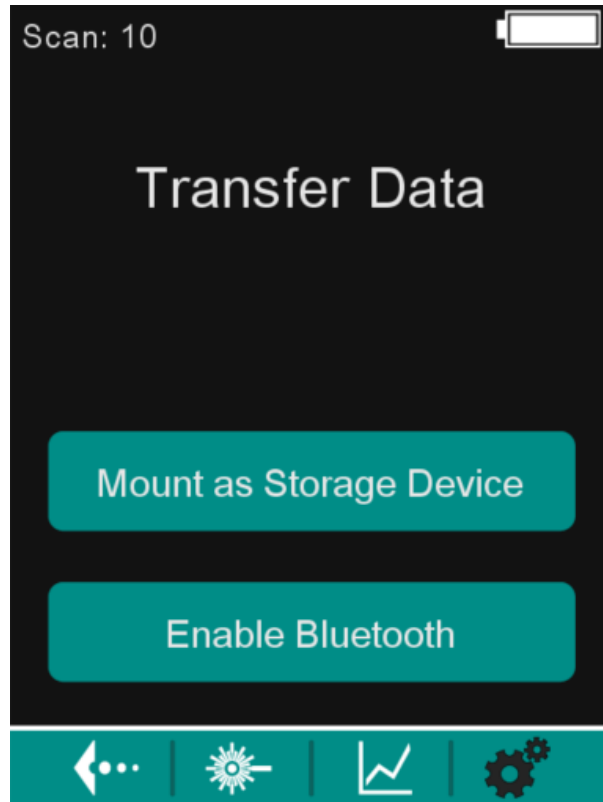

Select **[Enable Bluetooth]**.

The instrument indicates: **Bluetooth Mode**.

2 Pairing and connecting

On the Android device, open MIRA Cal M.

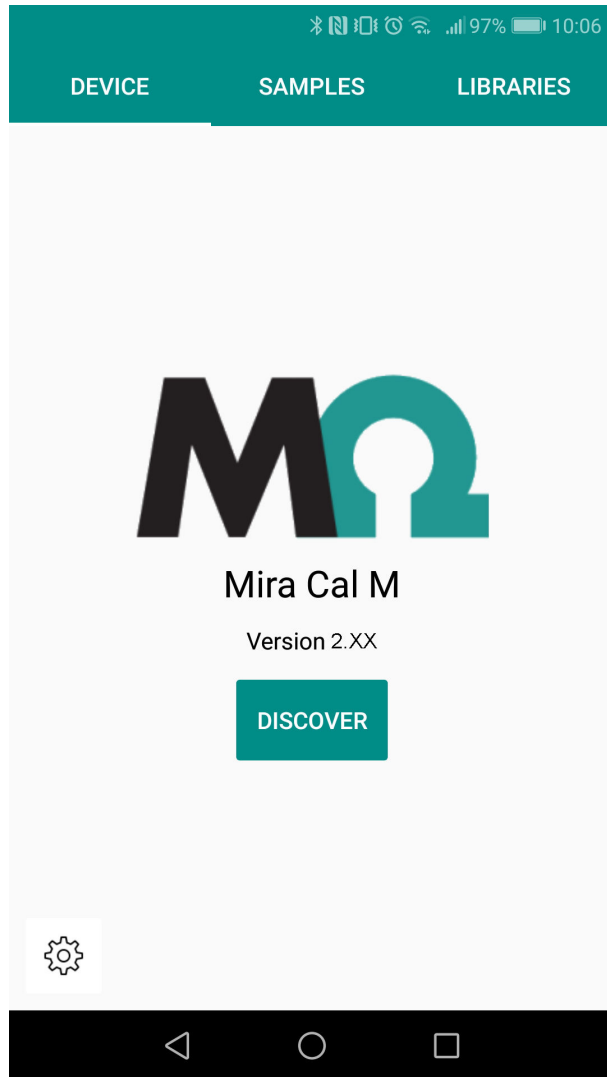

Select **Discover**.



NOTICE

The instrument will appear in the available devices with the model name followed by the serial number.

Example: MIRA DS 192600200020300000

If no devices are detected, ensure that Bluetooth is enabled on the Android device.

- 3 On the Android device, select MIRA DS 1926xxxxxxxxxxxxxx.

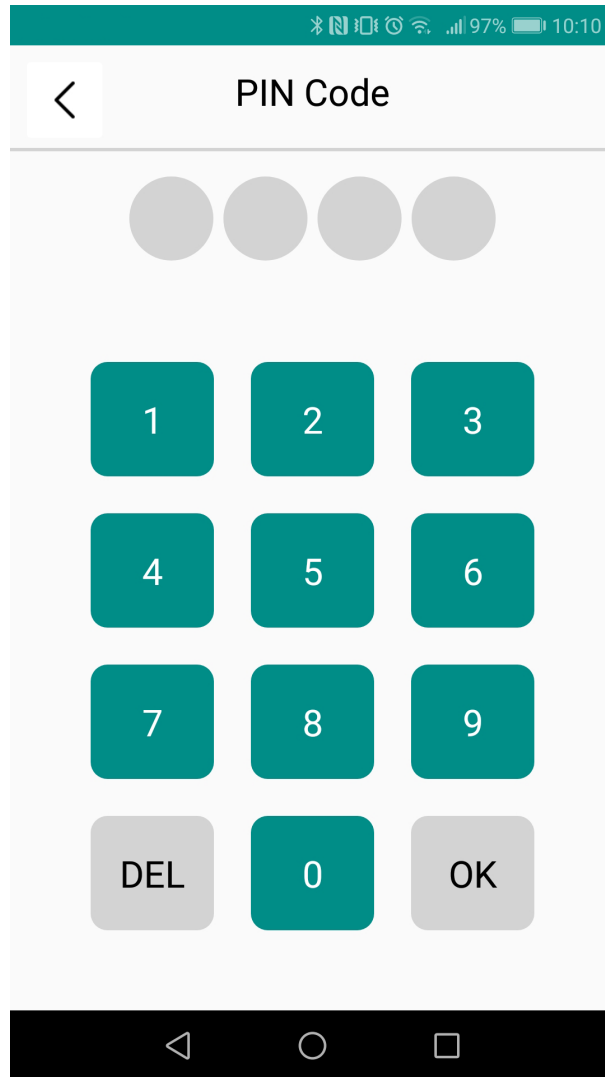

Enter the PIN code **9999**. Select **OK**.

The Android device is now connected to the instrument. The instrument is ready to transfer data or acquire a spectrum.

4 MIRA Cal M

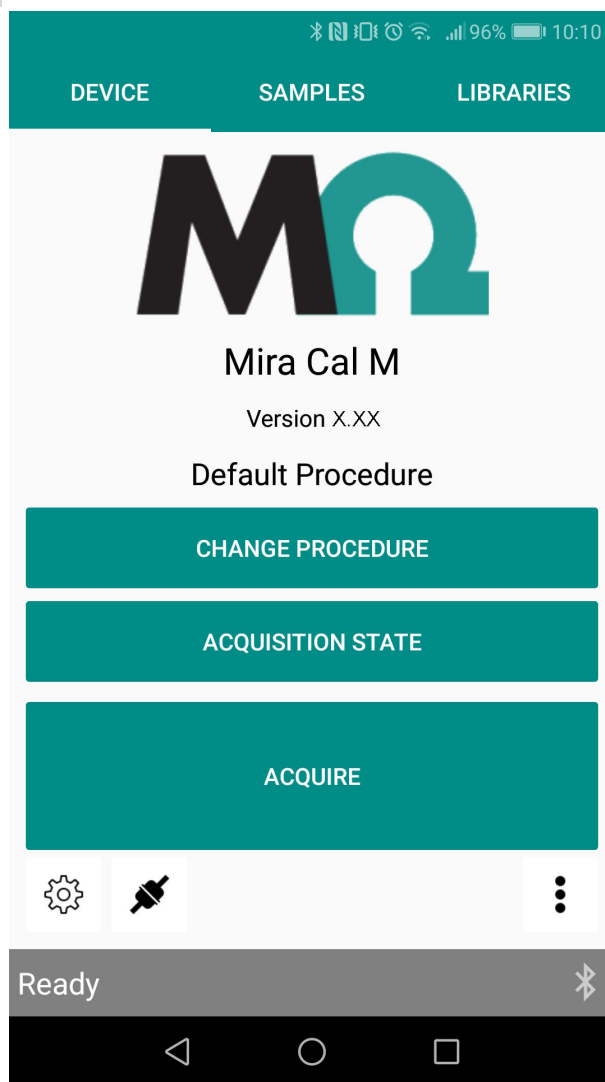

The DEVICE tab of MIRA Cal M allows changing of the procedure, editing of the acquisition state, and acquiring a spectrum.

5 Operating procedure

The display shows the current procedure, e.g.: **Default Procedure**.

The instrument is designed to be used with the default procedure. If one wishes to build and use a user procedure, be aware that this might affect the performance of the instrument matching algorithms. Select **[Change Procedure]** and select an operating procedure from the drop-down menu.



NOTICE

The default procedure will match the scanned sample to all of the enabled libraries present on the instrument. The default procedure enables smart acquire to automatically adjust laser power and integration time.



NOTICE

The SERS Attachment automatically enables a specialized SERS operating procedure. The SERS operating procedure optimizes acquisition parameters and references specific SERS libraries.

The intelligent Universal Attachment (iUA) automatically enables the specialized Content ID operating procedure. The Content ID operating procedure optimizes the identification of contents in polymer or glass containers.

6 App-based acquisition

In MIRA Cal M select **[Acquire]**.

MIRA Cal M indicates that the acquiring is in progress and the laser is active:



The instrument warns that the laser is active:



Figure 12 Warning symbol: Laser active

7 Downloading data from the instrument

- In the home screen of MIRA Cal M, open the menu .

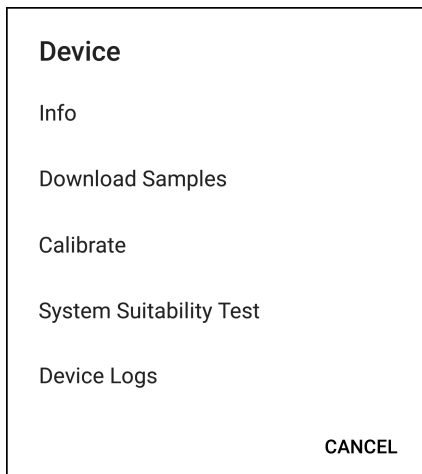

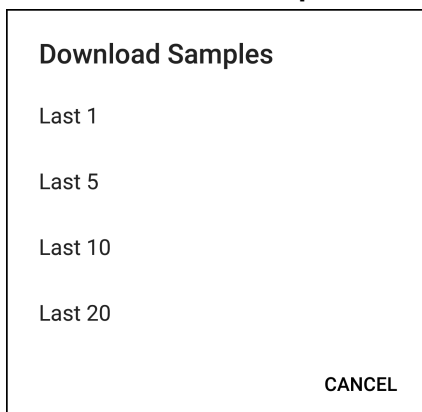

- Select **[Download Samples]**.



- Select the number of scans to download.

MIRA Cal M downloads the samples from the instrument.



8 Exporting data

- In MIRA Cal M, select **Samples**, , **[Export]**.
- Choose the information to be shared.  **[External Data]**.
- Choose the scans to be exported. 

The exported data can be found in the Android internal storage or memory card: **MetrohmRaman ► MIRACalM ► Exports ► Samples**

For example, you can connect the Android device to a Windows PC and access the exported data from the PC. Samples can be imported in MIRA Cal DS with **File ► Open ► Samples**.

9 Emailing data

- In MIRA Cal M, select **Samples**, , **[Export]**.
- Choose the information to be shared.  **[Email]**.
- Choose the scans to be sent.  Select the desired mail client or messenger and send the files.

10 Disconnecting

In MIRA Cal M, select .

Select **[Disconnect Bluetooth]**.

Viewing HazMasterG3 information

- 1 In MIRA Cal M, highlight the sample and select **Samples ► Haz-master Export**.
- 2 Open the HazMasterG3 app.
- 3 Select the top menu bar.
- 4 Select **DataFusion ► Sensor Import**.
The sample will display in the import.

Shutdown Delay

By default, no shutdown delay is configured.

To conserve battery charge, a shutdown delay can be specified. A battery-powered instrument will automatically shut down after the specified time.

- 1 Select , then **System Settings ► Shutdown Delay**.
- 2 Set the shutdown delay time.
Example: With the shutdown delay time **3**, a battery-powered instrument will automatically shut down after 3 minutes not in use.
Select **[Save]**.



NOTICE

The shutdown delay will only affect battery-powered instruments. For an instrument connected to a power supply, to a MIRA PowerPack or to a PC, the shutdown delay is disabled.

Language

- 1 Mount the instrument as Storage Device (see "Transfer Data: Mount the instrument as Storage Device", page 77).
- 2 Select the appropriate language pack from <https://www.metrohm.com/en/support-and-service/software-center/> and download the file.
- 3 Save the file to your MIRA device folder.

Name	Date modified	Type	Size
LanguagePack.tar	8/13/2021 1:07 PM	GZ File	5 KB

- 4 Reboot the device.



Select , then **System Settings ▶ Language**.



The new language will appear in the language screen.

5 Choose your preferred language.

The instrument supports the following languages:

- English
- German
- French
- Spanish
- Portuguese
- Chinese
- Italian
- Turkish
- Czech
- Hungarian

**NOTICE**

English is always the top button.

Only one language and English are supported on the device.

Battery Chemistry

There are many different types of AA batteries. For an accurate battery life indicator, it is important to choose the battery chemistry that is being used in the instrument. The supported chemistries are Li and NiMH.

Set the battery chemistry:**1**

Select , then **System Settings ► Battery Chemistry**.

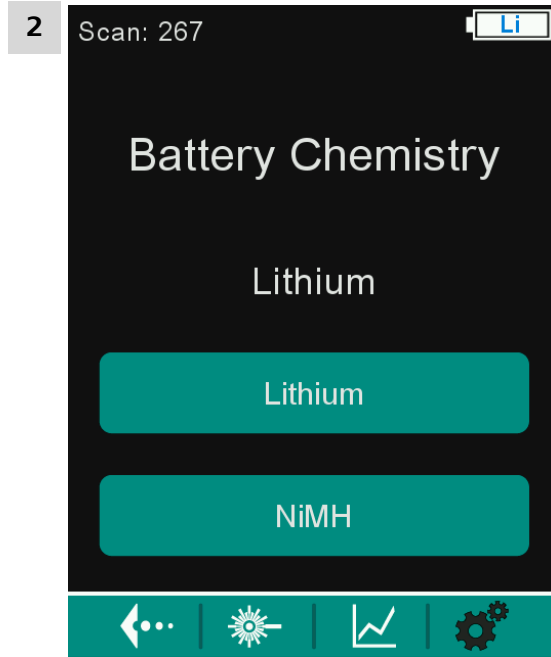

Select the battery type:

- Lithium
- NiMH

The change will be reflected by the text in the battery indicator. This setting is persistent.



NOTICE

We recommend to change the batteries when the battery indicator changes color from yellow to red.

7.7 Viewing and editing samples in the scan log

1 Accessing the scan log



Select  to view the saved spectra in the **Scan Log**.

The samples are listed as color-coded buttons:



Color code	Hazard level
Green	Safe
Orange	Caution
Red	Danger
Blue	No information
Grey	Inconclusive or Calibration

2 Accessing the sample menu

Select a scan number button to access the sample menu.

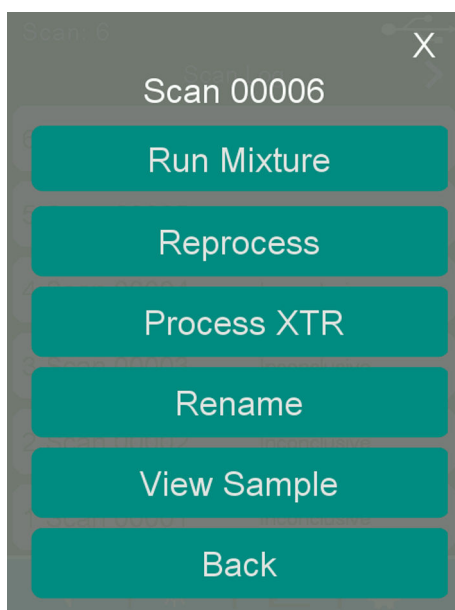

The sample menu appears as a list of buttons.

3 Run Mixture

Select **[Run Mixture]** to run the mixture matching routine against all enabled libraries on the instrument. Match name and spectra can be viewed.

4 Reprocess

A sample can be re-processed to match to a different enabled library. The function **[Reprocess]** uses the original operating procedure settings that were used to collect the data. Reprocessing may give different match score results. A new scan number will be assigned to the new match results. The match name and spectrum can be viewed.

5 Process XTR

A sample that was not processed using XTR data extraction can be post processed to show the results of the extraction. Once data is processed it can not be reprocessed with XTR extraction, the button will be grayed out.

6 Rename

Select **[Rename]** to rename a sample. Enter the new name. Confirm with **[Enter]**.

7 View Sample

Select **[View sample]** to view the spectrum, the match name and the CAS# of an acquired sample.

8 Back

Select **[Back]** to go back to the **Scan Log**.

7.8 Safe shutdown



NOTICE

To prevent unexpected behavior in the instrument, always perform a safe shutdown.

A **safe shutdown** is performed in the following cases:

- The on/off switch is pressed.
- The battery is low.
- A battery-powered instrument is not in use for the duration specified in the shutdown delay.

An **unsafe shutdown** is performed in the following cases:

- The on/off switch is pressed and held for 3 seconds or longer.
- The battery door is opened while running on batteries only.
- The USB is unplugged while running on USB only.

8 Maintenance

8.1 Cleaning the product surface

Regularly clean the product to prevent malfunctions and to ensure a long service life.

- Remove spilled chemicals immediately.
- Protect plug connections against contamination.



WARNING

Chemical hazardous substances

Contact with aggressive chemical substances may cause poisoning or chemical burns.

- Wear personal protective equipment (e.g. protective glasses, gloves).
- Use exhaust equipment when working with vaporizing hazardous substances.
- Clean contaminated surfaces.
- Only use detergents that do not cause any unwanted side reactions with the materials to be cleaned.
- Dispose of chemically contaminated materials (e.g. cleaning material) in accordance with regulations.



WARNING

Electrical potential

Contact with electrical potential can cause serious injuries or death.

- Operate the product only if it is in perfect condition. The housing must also be intact.
- Only use the product with the covers fitted.
- Protect live components (e.g. power supply unit, power cord, connection sockets) against moisture.
- Always have maintenance work and repairs on electrical components carried out by a regional Metrohm service representative.

Prerequisite:

- The product is switched off and disconnected from the energy supply.



Required accessories:

- Cleaning cloth (soft, lint-free)
- Water or ethanol

1 Clean the surface with a damp cloth. Remove persistent contamination with ethanol.

2 Wipe the surface with a dry cloth.

3 Clean the connectors with a dry cloth.



9 Disposal

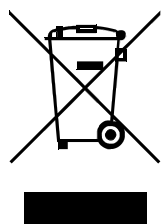

Properly dispose of chemicals and of the product to reduce negative effects on the environment and public health. Local authorities, waste disposal companies or dealers provide more detailed information on disposal. Observe the WEEE EU directive (WEEE = Waste Electrical and Electronic Equipment) for the proper disposal of waste electronic equipment within the European Union.



10 Technical specifications

10.1 Ambient conditions

MIRA DS and MIRA XTR DS

Nominal function range	-20 to +50 °C	at max. 93% relative humidity, noncondensing
Storage and Transport	-20 to +70 °C	at max. 93% relative humidity, noncondensing

MIRA PowerPack

Nominal function range	-20 to +50 °C	at max. 93% relative humidity, noncondensing
Charging	0 to +30 °C	at max. 93% relative humidity, noncondensing
Storage	0 to +35 °C at 25–50% Charge	at max. 93% relative humidity, noncondensing
Transport	max. 1 week, -20 to +70 °C	at max. 93% relative humidity, noncondensing

10.2 Interfaces

USB connector	Type A/B mini USB connector (USB 3.0) with the following functions:	Power supply Data transmission with USB cable (6.2151.110)
----------------------	---	--

10.3 Energy Supply

Battery specifications	2 x 1.5 V, size AA	up to 3.5 hours
Nominal input voltage	5 V DC	
Power consumption	1,300 mA max.	
USB Mini-A/B Power Requirements		instrument connected to a powered USB hub
<i>Input voltage</i>	5 V DC	
<i>Nominal input current</i>	1,500 mA max.	

10.4 Dimensions and materials

Dimensions

<i>Width</i>	88.2 mm
<i>Depth</i>	45.3 mm
<i>Height</i>	125.5 mm
<i>Display</i>	3.7" TFT LCD Display, glove compatible

Samples for Vial Holder

<i>Vial Holder</i>	Vials 15 mm x 26 mm
--------------------	---------------------



Weight	705 g
Material	
<i>Housing</i>	Aluminum anodized
<i>Accessories covering</i>	Thermoplastic elastomers (TPE-E)
<i>IP Rating (according to EN 60529)</i>	IP67
Ruggedization	
	MIL-STD-810G Method 514.6C-1, C-2, C-3 Category 4
	MIL-STD-810 Method 516.6 Procedure IV
	MIL-STD-810G Method 516.6 Procedure VI
	MIL-STD-810G Method 512.5 Procedure I
	IEC 60529 Dust

10.5 Operating specifications

Laser wavelength	785 nm ± 0.5 nm
Laser output power	≤ 100 mW
Wavenumber range	400–2,300 cm ⁻¹
Spectral resolution	8–10 cm ⁻¹ (FWHM)
Collection optics	NA = 0.50, 1 mm and 7.6 mm working distance; 0.042–2.5 mm measuring spot size



Beam divergence	2 degrees
Temporal emission structure	CW
Detection technique	Orbital Raster Scan (ORS™) to average over the sample
Laser class according to EN 60825-1	Class 3B
Protection Level of protective glasses (according to EN 207)	D LB5775–795 nm

**NOHD – Nominal Ocular Hazard Dis-
tance**

<i>Contact Ball-Probe</i>	34.5 cm
<i>Stand-off Attachment at 0.25 m set- ting</i>	12 m
<i>Autofocus Stand-off Attachment at 0.3 m setting</i>	12 m
<i>Stand-off Attachment or Autofocus Stand-off Attachment at 1.5 m setting</i>	125 m
<i>Right Angle Attachment</i>	34 cm ± 5 cm
<i>Universal Attachment</i>	34 cm ± 5 cm
<i>iUA - intelligent Universal Attachment</i>	34 cm ± 5 cm
<i>Short Working Distance Attachment Lens (SWD)</i>	34 cm ± 5 cm
<i>Long Working Distance Attachment Lens (LWD)</i>	34 cm ± 5 cm
<i>Extra Long Working Distance Attach- ment Lens (XLWD)</i>	66 cm ± 5 cm
<i>SERS Attachment</i>	34 cm ± 5 cm