

A Guide to Preparing and Analyzing Chlorinated Pesticides.....



Inside:

***Extraction Methods
for Liquid, Solid,
and Biota Samples***

.....

***Sample Cleanup
Methods***

.....

***Analysis of Chlorinated
Pesticides***

.....

Summary

.....

Table of Contents

Overview 2

Extraction Methods for Liquid, Solid, and Biota Samples 3

- Liquid Samples
 - Separatory Funnel Extraction
 - Liquid-Liquid Extraction
 - Solid Phase Extraction
- Soil Samples
 - Sonication or Soxhlet Extraction
 - Solvent Selection

Sample Cleanup Methods 6

- Sulfur and Lipid Contaminants: Gel Permeation Chromatography
- Polar Contaminants and Co-Extractants: Adsorbent SPE Tubes
- Double-Bond, Triple-Bond, or Aromatic Compound Contamination: Sulfuric Acid Cleanup
- General Contaminants: Carbon Cleanup
- Sulfur Contamination: Mercury, Activated Copper Powder Cleanup

Analysis of Chlorinated Pesticides 9

- Calibration
- Injection Port Maintenance
- Cold On-Column Injections
- Direct Injections
- Split/Splitless Injections
- Resolution Discussion

Summary 14

Product Listings 18

For tech support, call
800-356-1688, ext. 4
 (814-353-1300, ext. 4)

The analysis of chlorinated pesticides (as stated in US Environmental Protection Agency (EPA) Methods 8081, 508, and 608) and polychlorinated biphenyls (PCBs) (as stated in US EPA Methods 8081 and 8082), are some of the most common tests performed by environmental laboratories. However, many laboratories struggle with them because the samples often are highly contaminated with non-target compounds such as lipids and hydrocarbons, and the methods require rigorous quality control. Several techniques, used in combination with Restek's Rtx[®]-CLPesticides column and Rtx[®]-CLPesticides 2 column, can help you more simply perform these analyses.

The compounds addressed in these methods are listed in Table I. The table includes additional compounds typically analyzed using the same methods. Herbicide compounds (US EPA Method 8151) also are listed because many laboratories use the same instrument to analyze both pesticides and herbicides. Although the separation of herbicides is included in this guide, the extraction of them, which is significantly different than for pesticides, is not included. If you are involved in the preparation and analysis of the herbicides and would like more information, please contact Restek's technical service.

Table I

US EPA 508

aldrin	chlorneb	etridiazole
Aroclor [®] 1016*	chlorobenzilate	heptachlor
Aroclor [®] 1221*	chlorothalonil	heptachlor epoxide
Aroclor [®] 1232*	DCPA	hexachlorobenzene
Aroclor [®] 1242*	4,4'-DDD	methoxychlor
Aroclor [®] 1248*	4,4'-DDE	cis-permethrin
Aroclor [®] 1254*	4,4'-DDT	trans-permethrin
Aroclor [®] 1260*	dieldrin	propachlor
α -BHC (α -HCH)	endosulfan I	technical chlordane*
β -BHC (β -HCH)	endosulfan II	trifluralin
δ -BHC (δ -HCH)	endosulfan sulfate	toxaphene*
γ -BHC (γ -HCH, lindane)	endrin	
α -chlordane	endrin aldehyde	
γ -chlordane	endrin ketone	

US EPA 608

aldrin	δ -BHC (δ -HCH)	endrin aldehyde
Aroclor [®] 1016*	γ -BHC (γ -HCH, lindane)	endrin ketone
Aroclor [®] 1221*	4,4'-DDD	heptachlor
Aroclor [®] 1232*	4,4'-DDE	heptachlor epoxide
Aroclor [®] 1242*	4,4'-DDT	technical chlordane*
Aroclor [®] 1248*	dieldrin	toxaphene*
Aroclor [®] 1254*	endosulfan I	
Aroclor [®] 1260*	endosulfan II	
α -BHC (α -HCH)	endosulfan sulfate	
β -BHC (β -HCH)	endrin	

US EPA 8081

aldrin	α -BHC (α -HCH)	endrin aldehyde
Aroclor [®] 1016*	β -BHC (β -HCH)	endrin ketone
Aroclor [®] 1221*	δ -BHC (δ -HCH)	heptachlor
Aroclor [®] 1232*	γ -BHC (γ -HCH, lindane)	heptachlor epoxide
Aroclor [®] 1242*	α -chlordane	methoxychlor
Aroclor [®] 1248*	γ -chlordane	technical chlordane*
Aroclor [®] 1254*	dieldrin	toxaphene*
Aroclor [®] 1260*	endosulfan I	
4,4'-DDD	endosulfan II	
4,4'-DDE	endosulfan sulfate	
4,4'-DDT	endrin	

*Multi-component standards.

Table I, cont.**US EPA 8081 Additional Compounds**

alachlor	metalachlor	pentachloronitrobenzene
atrazine	metribuzin	simazine
cyanozine		

US EPA 8151 (herbicides)

acidfluorfen	DCPA	4-nitrophenol
bentazon	dicamba	pentachlorophenol
chloramben	3,5-dichlorobenzoic acid	picloram
2,4-D	dichloroprop	2,4,5-T
dalapon	dinoseb	2,4,5-TP (Silvex)
2,4-DB	MCPA	
DCAA	MCPP	

Common Surrogates

2,4-DA (herbicide)	decachlorobiphenyl	2,4,5,6-tetrachloro-m-xylene
--------------------	--------------------	------------------------------

Extraction Methods for Liquid, Solid, and Biota Samples

All of the pesticide compounds listed in Table I, except the US EPA 8151 herbicides, are extracted under neutral conditions using a variety of organic solvents. There are several sample extraction methods that can be applied, but the most common will be addressed here.

Liquid Samples

For liquid samples, you can use either separatory funnel extraction (US EPA Method 3510) or automated liquid-liquid extraction (US EPA Method 3520). In comparison, separatory funnel extraction is faster and less expensive to set up, but requires continuous attention. Automated liquid-liquid extractors can operate unattended, but are more expensive. For some methods, if analyte recovery is lower than allowed, you must re-extract the sample by separatory funnel. Alternatively, if the sample forms an emulsion to the degree that acceptable solvent recovery is not possible using a separatory funnel, then some methods require liquid-liquid extraction.

According to US EPA Method 3535, solid phase extraction (SPE) can be used to extract pesticide compounds from aqueous samples.

Separatory Funnel Extraction

For separatory funnel extraction, measure up to 1L of sample into a 2L separatory funnel, and check the pH. Adjust the pH to neutral using hydrochloric acid or sodium hydroxide, depending on the starting pH. Avoid using sulfuric acid (see *Sulfuric Acid Cleanup* on page 8). If adjustment is necessary, record on your sample tracking paperwork.

Extract the sample by adding 60mL of dichloromethane and shaking for two minutes. It is critical to shake all samples in the same manner or you may see variations in extraction efficiency—the best way to ensure consistency is to use a mechanical separatory funnel shaker. The dichloromethane settles to the bottom of the separatory funnel and then is decanted through a sodium sulfate tube into a collection vessel such as a Kuderna-Danish (KD) concentrator or into a TurboVap® or RapidVap® container if using automated concentrators. This step is repeated two more times to achieve quantitative recovery of all analytes (collect all three extractions into the same collection vessel).

Use SPE (US EPA Method 3535), separatory funnel extraction (US EPA Method 3510), or automated liquid-liquid extraction (US EPA Method 3520) for liquid samples.

Removing water from the dichloromethane with sodium sulfate is critical before the extract is concentrated to final volume. Dichloromethane can hold approximately 1 mL of water per liter. If water remains in the extract, it will partition out of the extract when the volume is reduced. If this occurs, either the dichloromethane will evaporate first, leaving only water in the collection vessel, or a two-layer extract will form. In either event, the recoveries of the analytes will be lower than desired, and the presence of water will interfere with gas chromatographic (GC) analysis.

The best way to remove the water is to decant the dichloromethane extract through granular sodium sulfate held in a funnel with a high-quality grade (Whatman 541) filter paper or glass wool. Approximately 30g of sodium sulfate is sufficient for most samples. This step must not be skipped! Some methods may call for powdered sodium sulfate, but some analytes are adsorbed to the smaller particles, so only a 10-60 mesh granular sodium sulfate or equivalent should be used. It also is important that this material be free from organic contaminants, so it should be purchased as ACS pesticide residue grade in glass containers. If purchased in bulk packages where exposure to plastic is an issue, bake in a muffle furnace. To bake the sodium sulfate, spread it no more than 1-inch thick into an appropriate container and place into a muffle furnace, baking at 400°C for a minimum of two hours. After this time, place the sodium sulfate into a glass container while still hot, and cap the container to keep the material from resorbing contaminants from the atmosphere. If a muffle furnace is not available, wash the sodium sulfate or extract it with dichloromethane prior to use. This technique is extremely wasteful of solvent, making the muffle furnace preferable.



SPE allows very fast extraction times and low solvent volumes; it also is easily used in the field.

For ordering information, see product listings beginning on page 18.

Liquid-Liquid Extraction

Liquid-liquid extraction offers unattended extraction once the samples are ready and the solvent is added. Extraction is performed under neutral conditions and the recoveries are excellent for chlorinated pesticides. Set up of the extractors should be done following manufacturer specifications. Due to the extended contact time of the organic compounds with the glass surfaces, reactive compounds could breakdown if these surfaces became contaminated. Although, with the use of proper washing procedures, this is uncommon. As with the separatory funnel technique, the use of granular sodium sulfate is important to yield a dry dichloromethane extract.

Liquid-liquid extractors are available in two versions, conventional and accelerated. The accelerated type uses a hydrophobic membrane to separate the aqueous and the organic phases, and the extraction time can be cut to $\frac{1}{3}$ or $\frac{1}{4}$ of the conventional extractor time. These membranes are expensive and it is important to analyze the cost versus the number of samples extracted to determine if there is a benefit to using this technique.

Solid Phase Extraction (SPE)

Finally, SPE also is used for the extraction of pesticide and herbicide compounds from aqueous samples (US EPA Methods 3535, 508, and 515). When using SPE, it is extremely important to follow the manufacturer's recommendations on the use of the material. There are several manufacturers of C18 tubes and disks, which are the typical media used for these compounds, and the extraction steps will vary somewhat depending on the manufacturer. In general, the biggest drawbacks with SPE are the plugging of the disk or tube with suspended solids and the breakthrough of targeted organics; therefore this extraction method works most reliably if contamination levels and solids are low. SPE allows very fast extraction times and low solvent volumes; it also is easily used in the field.

Soil Samples

For soil samples, soxhlet or ultrasonic extraction have been the most common extraction methods; although pressurized fluid, microwave, and supercritical fluid extraction (SFE) are used as well.

Pressurized fluid extraction (US EPA Method 3545) runs unattended, but has some sample size limitations. Generally, no more than 10g of sample can be extracted without using multiple vessels, so detection limits may be compromised for certain analytical methods. It is important to take this into consideration when evaluating the use of either pressurized fluid or microwave extraction.

Although not currently cited by the US EPA, microwave extraction can be useful for automated extraction as well. Microwave extraction extracts 12 samples simultaneously, but does require slightly more operator handling than the pressurized fluid extraction instruments. The instrumentation is less expensive than the pressurized fluid instrumentation, but lack of an EPA method has limited the use of this technique in the US.

Supercritical fluid extraction has been promoted for a number of years as a “solventless” extraction technique for environmental samples. SFE was added to SW-846 as Method 3560, but its application is limited. SFE suffers from severe matrix-related variation, resulting in the need to modify the SFE conditions depending on soil type, water content, sample size, and the type of analytes. This ultimately requires additional sample preparation prior to the actual extraction. These requirements, added to the high cost of these instruments, has virtually precluded the use of SFE for environmental sample preparation.

Sonication or Soxhlet Extraction

Sonication or soxhlet extraction works well for chlorinated pesticides and PCBs. Sonication is a faster technique, but requires constant operator attention. In both techniques, problems such as contamination are attributed to either contaminated reagents, especially sodium sulfate, or poor laboratory practices being used when transferring sample extracts. Using sodium sulfate to remove water (described on page 4) is important. Mix the sample with sodium sulfate to achieve a sandy consistency prior to solvent addition. Using granular sodium sulfate is recommended because some of the pesticides will adsorb to the powdered material.

Solvent Selection

Since soil and biota samples are essentially wet particles, acetone and dichloromethane usually are used in a 1:1 combination as the extraction solvent. The acetone is needed to adequately penetrate into the soil particle so that compounds contained in the particle can be extracted. Several other solvent systems can be used for unique extractions, but generally this combination works for most applications. Use pesticide residue grade solvents for this application and run solvent assays to verify the material prior to its use. To perform a solvent assay, reduce 300 to 400mL of solvent to a final volume of 1mL, and exchange to hexane for analysis by GC/ECD (electron capture detection). The extract analysis should have no chromatographic peaks above 50% of the detection limit for any target compound.

Finally, with regards to solvent selection, it is important to note that dichloromethane will form hydrochloric acid spontaneously without a stabilizer present. There are two classes of stabilizers: stabilizers that keep hydrochloric acid from forming, and stabilizers that eliminate hydrochloric acid upon formation. Methanol and cyclohexane are used to stop hydrochloric acid from forming. If water samples are extracted with dichloromethane contain-



Soxhlet and ultrasonic extraction are the most common extraction methods for soil samples; although pressurized fluid, microwave, and supercritical fluid extraction can be used as well.

ing methanol as the stabilizer, the methanol will partition into the water, leaving an unstabilized extract. Hydrochloric acid forms quickly in unstabilized dichloromethane, and injection of an acidic solvent will result in reactivity of liners and columns. The second type of stabilizers are alkene compounds, which are used to reduce hydrochloric acid upon formation. It is desirable to use an alkene stabilizer that is low-boiling to prevent interference with early eluting target compounds.

Sample Cleanup Methods

Sample extract cleanup is probably the most important step in maintaining long-term instrument performance.

Sample extract cleanup is probably the most important step in maintaining long-term instrument performance. Generally, when instrument problems arise, they are caused by exposure of the injection port and the column to contaminants in the sample extracts. While all of these contaminants cannot be eliminated, most can be reduced to levels where they become much less of an issue. Contained in many pesticide and PCB extracts are hydrocarbons, sulfur, phthalate esters, and lipids in the case of biota samples. Many of these compounds can be removed from the extract by one or more of the following techniques, with little additional cost or time, which usually can be recovered by an increase in instrumental stability, a decrease in instrument maintenance, and possible improvements in detection limits.

Sulfur and Lipid Contaminants: Gel Permeation Chromatography

Gel permeation chromatography (GPC) is a preparative-scale chromatographic method of separation based on molecular size. Since the target compounds are similar in molecular size, they elute as a band of material and are easily separated from lighter and heavier contaminants. For the pesticide and PCB extracts, GPC is a very efficient method for removing sulfur and lipids. GPC is the only cleanup technique cited here that requires considerable expense, and the processing time per sample is between 30 to 70 minutes. For these reasons, many laboratories choose not to use GPC. However, for soil and biota samples, GPC is the most prudent cleanup method.

Sulfur also can be eliminated using mercury or activated copper powder, but lipids are not as easily removed. Lipid content of biota extracts can be several orders of magnitude higher than that handled using SPE methods, so GPC is still a good alternative. If sample extracts with high lipid content are injected into the GC, the injection port and head of the column will quickly become contaminated, resulting in failure of continuing check standards.

For ordering information, see product listings beginning on page 18.

US EPA Method 3640 details the requirements for GPC cleanup of extracts for pesticide and PCB analysis. If the sample is to be analyzed for PCBs only, the sulfuric acid cleanup (US EPA Method 3665) described on page 8 is more cost effective than Method 3640, but is not amenable to all the pesticides. When performing a GPC cleanup, verify the instrument retention time calibration on a daily basis or before processing the next batch of samples, whichever is less frequent. If a number of samples have been processed that contain large amounts of contamination, the front of the GPC column can become reactive. This is typically observed in the loss of 2,4,6-tribromophenol for semivolatile extracts, but it may not be as easily observed in the pesticide GPC standard. The use of a 2-3" guard column can prevent repacking of the 70g analytical column.

GPC columns also are very sensitive to slight changes in mobile phase composition (solvent variations). Because soil and biota samples typically are extracted using a solvent mixture, and dichloromethane is the lowest boiling solvent, it will evaporate first when the extract is concentrated. This leaves nearly 100% acetone in the concentration vessel. If dichloromethane is then added to adjust the extract to volume, significant amounts of acetone will be introduced into the GPC column. This will lead to "solvent shock" and the

formation of a void at the front of the column. This, in turn, will effect the retention times of the compounds eluting from the GPC column and ultimately result in the possibility of some target compounds being uncollected. Therefore, to avoid large amounts of acetone being applied to the column, it is critical that all extracts be reduced to as small a volume as possible prior to reconstitution in dichloromethane.

Polar Contaminants and Co-Extractants: Adsorbent SPE Tubes

Both Florisil® and silica adsorbents have been used since the 1960s for chromatographic cleanup and fractionation of environmental samples, especially those containing chlorinated pesticides. Florisil® is a magnesium silicate, while silica is manufactured from a sodium silicate sol. Originally tested and used in manually-packed, large open-column cleanup procedures, these adsorbents were found to be useful in retaining polar contaminants from soil and waste samples that had been extracted with organic solvents such as hexane. They are ideal for retaining co-extractants, such as phenols, that may interfere with GC analysis of pesticides, PCBs, and chlorinated hydrocarbons. Large Florisil® tubes also were used to fractionate pesticide groups based on small differences in polarity, by eluting with increasing percentages of polar solvents such as ethyl ether.¹ Testing based on this method is a standard QA procedure for pesticide-grade Florisil® adsorbent. All grades of these bulk adsorbents should be heat-activated at 130°C for 16 hours, stored in a sealed glass container, and cooled to room temperature before being manually packed into glass tubes.²

To increase laboratory efficiency and reduce the amount of solvents used for these processes, the US EPA has allowed the use of pre-packed SPE tubes containing Florisil® or silica packing. These small tubes are convenient to use, require less solvent, and still are effective. They will cleanup small volumes of pesticide-containing or chlorinated hydrocarbon-containing samples. They often are used after GPC cleanup, as recommended in SW 846. Details on the appropriate use and preparation of these cartridges is contained in SW 846 Method 3620B, 3630C, and in the CLP Pesticides Statement of Work (SOW).³

It is very important to evaluate each lot of tubes to ensure minimal background from the device itself, and to verify that the packing is at maximum activity level to maintain the expected retention capacity. These tubes are available with stainless steel or PTFE frits to reduce interferences from phthalates, which may be extracted from typical polyethylene frit materials. Using adsorbent beds of 1g or more and slower gravity elution of the samples will minimize premature breakthrough or channeling and ensure maximum recoveries in each recovered fraction.

References

1. *J. of AOAC*, Ch. 24, 208, Vol. 49, Nov.1 (1966), p. 223
2. "Test Methods for Evaluating Solid Waste Physical/Chemical Methods (US EPA SW 846) Final Update III," December 1996. Available from the US government, Mail Stop: SSOP, Washington, DC, 20402-9328.
3. US EPA Contract Laboratory Program, *Statement of Work for Organic Analysis OLM04.0*, Exhibit D Pesticides/Aroclors.

References not available from Restek.



To increase laboratory efficiency and reduce the amount of solvents used for extract cleanup, the US EPA has allowed the use of pre-packed SPE tubes containing Florisil® or silica packing.

Refer to page 19 for SPE ordering information. For additional questions on the use of Florisil® SPE, refer to the appropriate EPA Method, request Applications Note #59562 from Restek, or call Technical Service at 800-356-1688 or 814-353-1300, ext. 4.

Contamination from Double-Bond, Triple-Bond, or Aromatic Compounds: Sulfuric Acid Cleanup

Sulfuric acid will add to nearly any double-bond, triple-bond, or aromatic compound, producing a compound that has the general structure shown in Figure 1. The only compounds that do not undergo this reaction are those with single bonds, or compounds that are stabilized by groups, which make

the multiple bond inaccessible to sulfuric acid addition. This reaction can be used to convert nearly every compound found in pesticide and PCB extracts, from organic-soluble compounds to aqueous-soluble compounds. The resulting organic phase then can be removed and concentrated, resulting in a much less contaminated extract. It is important to note that many of the pesticides will undergo this reaction, so this cleanup can only be used for PCB analysis.

To perform sulfuric acid cleanup, place the hexane extract in a vial about 3- to 4-times the volume of the extract. Add an equal amount of 1:1 sulfuric acid, cap the vial, and shake for a few minutes. Most of the color will be transferred to the aqueous (bottom) layer as the reaction progresses. Allow the layers to separate either by standing or

centrifugation. Using a glass pipette, quantitatively remove the hexane (top) layer and transfer to a KD or a concentrator vial. If the hexane extract still has significant color, repeat the steps until no more color is exchanged into the aqueous layer. Once the extract has been transferred to the KD or concentrator vial, reduce it to final volume.

Following sulfuric acid cleanup, primarily only hydrocarbons, sulfur, some chlorinated pesticides, and PCBs will be remaining.

General Contaminants: Carbon Cleanup

For many years, activated charcoal has been used to separate target compounds from sample matrix interferences. Past problems have included lot-to-lot variability of the material itself, as well as manual column packing inconsistencies, which often resulted in variable elution patterns. Labs were required to test each new lot of charcoal, and then correct the required elution solvent volumes. Over the last decade, development of a new, chromatographic-grade graphitized carbon has provided a more consistent product with predictable elution behavior. This carbon material has far fewer contaminants than charcoal and also is available in commercially prepacked cartridges, which further increases performance reproducibility.

Graphitized carbon tubes have a unique elution pattern characteristic compared to Florisil®, alumina, and silica gel tubes; and have higher sample capacity in comparison to C18 tubes. In general, carbon elutes polar compounds first, then nonpolar compounds. For this reason, carbon makes a very good absorbent to remove nonpolar matrix interferences from sample extracts.

Graphitized carbon is a versatile, nonporous adsorbent, which retains or extracts a variety of compounds. The extraction system may be adjusted to retain and elute aliphatic, aromatic, polar, and nonpolar analytes. For optimal recoveries, compounds of interest should be applied in weak solvents, or

Figure 1: Sulfuric acid will add to nearly any double-bond, triple-bond, or aromatic compound, producing a compound that has this general structure:

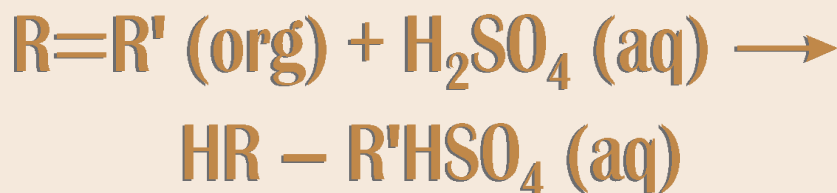

Over the last decade, development of a new, chromatographic-grade graphitized carbon has provided a more consistent product with predictable elution behavior.

solutions with low solubility for the analytes, and eluted in strong solvents. Mixed solvent systems, including dichloromethane, often are the most effective for elution. Carbon cartridges will retain pesticides and PCBs when introduced as low volume (1mL) hexane extracts. They will retain the non-polar sample interferences and release the chlorinated pesticides using up to 20mL of a 20% dichloromethane/hexane solution*. However, caution should be taken when using graphitized carbon to clean extracts for PCB analysis because the coplanar PCB congeners BZ#77, 81, 126, and 169 are retained and do not elute using the above solvent. These congeners can be eluted using a 1:1 mixture of ethyl acetate and benzene.

**Due to the uniqueness and high capacity of graphitized carbon, all fractionation and elution volumes should be verified from lot to lot.*

Sulfur Contamination: Mercury, Activated Copper Powder Cleanup

Sulfur also is a common contaminant in pesticide and PCB extracts, and it produces a large signal on an ECD. Sulfur can be removed using GPC or one of the many cleanup procedures listed in US EPA Method 3660.

Mercury added directly to the extract vial is probably the best method for removing sulfur. (Note: Due to the hazardous nature of mercury, use caution while working with this substance.) Add a few drops of mercury to the hexane extract. The sulfur is then converted from an organic soluble species to mercury sulfide on the surface of the mercury drop, which appears as a black powder. The hexane is then pipetted off and re-vialed. Repeat this procedure until this reaction no longer occurs.

Activated copper powder also removes sulfur, but can react with some of the chlorinated pesticides if the exposure time is too long. The first compound to show signs of this reaction is usually heptachlor. The best way to use this cleanup method is to apply the activated copper powder to the top of a Florisil® SPE tube, so that the cleanup is performed as the sample passes through the cartridge, resulting in minimum exposure time. Sulfur cleanup is not amenable to the organophosphorous pesticides as several of them break down in the presence of activated copper or mercury.

Refer to page 19 for SPE tube ordering information.

Analysis of Chlorinated Pesticides

Calibration

The instrument used for the analysis of pesticides and PCBs must be calibrated prior to performing quantitative analysis. The calibration should be linear over a 16- to 100-fold concentration range. The calibration of 3 to 5 points includes analyzing a low-point standard to meet the required reporting limit, as well as a high-point standard to minimize the need for dilutions. The linearity check should contain all the pesticides being reported. The necessity to verify linearity for all target compounds is important because the different classes of pesticides (i.e., α -BHC vs. methoxychlor) will cause differences in injection port discrimination, chromatographic peak shape, or detector linearity.

Aroclor® standards are mixtures of chlorinated biphenyls, called congeners. The linearity of the PCB congeners is consistent from the monochlorinated biphenyls to decachlorobiphenyl. For some methods, running calibration curves for three Aroclor® standards covering the entire analytical range (i.e., 1242, 1254, and 1260), followed by the analysis of a single concentration for each remaining Aroclor® standard is sufficient. See pages 19-22 for common calibration standards.

Injection Port Maintenance

The injection port is where a majority of analytical problems occur in the analysis of pesticides. The main problem is the cleanliness and inertness of the injection port with which the sample extract comes in contact. The two compounds used to check the injection port inertness are endrin and 4,4'-DDT. The breakdown components monitored for each compound are endrin aldehyde and endrin ketone, and 4,4'-DDE and 4,4'-DDD, respectively.

The breakdown of 4,4'-DDT is generally indicative of a dirty injection port caused by the analysis of oily or "dirty" sample extracts. Replacing the liner and cutting 6-12 inches off of the guard column usually is needed to bring the system back to the original state. Sample extracts causing 4,4'-DDT breakdown usually need GPC or carbon column cleanup to separate the pesticide from the sample matrix interferences.

Endrin breakdown is usually indicative of a chemical reaction taking place in the injection port. The breakdown could be caused by impurities in the carrier gas, active metal surface, a non-deactivated liner or septa particles.

The carrier gas is usually the last troubleshooting area investigated and the hardest to eliminate. Endrin may react with a contaminate being carried into the injection port by the carrier gas. Having gas scrubbers in-line for the carrier gas will help keep this problem from occurring. In some instances, a contaminate, such as argon, in the helium carrier gas has been found when high endrin breakdown has occurred. To check for contaminated helium, use a GC/mass spectrometer (MS). For example, scan for mass 40 to check for argon contamination.

When the extract is injected into the hot injection port, the extract backflash that escapes from the top and bottom of the liner comes into contact with metal surfaces. Therefore, the metal surfaces of the injection port must be kept clean, including the inlet carrier gas line. Periodic rinsing of the carrier gas lines and swabbing out the injection port may be necessary if endrin or 4,4'-DDT breakdown increases over short periods of time or when only analyzing standards. Rinsing of the metal surfaces using solvents, or in some cases silanizing the injection port, has helped. To solvent rinse, trace the carrier gas line from the injection port back to the first connection, rinse from that point to the injection port with solvents using a syringe or HPLC pump. Do not flush solvent through any actuator valves or rubber parts, and rinse with injection port at room temperature.

Improperly deactivated injection port liners will also cause endrin breakdown. The best way to avoid this problem is to replace the liner with a newly deactivated liner when performing routine maintenance. There are two approaches to liner deactivation: perform the operation in-house or send liners out to be deactivated. Sending injection port liners to a company like Restek for cleaning and deactivating is inexpensive and keeps analysts from spending time chemically deactivating liners. There is a standard procedure for deactivating liners that includes a process of cleaning the liners in acid and deactivating with dichlorodimethylsilane. Call Restek's technical service for more information on this procedure.

Septa particles are a major cause of endrin breakdown. The septa particles will sit on top of a glass wool plug or at the bottom of the liner. Generally, filing down the burrs on the end of the syringe needle will help eliminate the coring. Another approach is to try different septa that feature reduced coring. As technologies change, new septa are investigated for their bleed characteristics and softness at different temperatures. The latest technologies on septa are available by requesting *A Guide to Minimizing Septa Problems* (lit. cat.# 59886).

The effects of chromatographic peak shape on linearity vary widely. In some cases, as with endrin aldehyde on the cyanopropyl phases (i.e., 1701 phase),

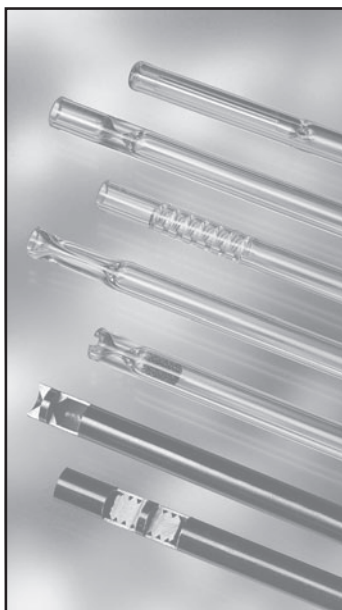

All Restek liners are deactivated for maximum inertness and minimum pesticide breakdown. Order our Inlet Supplies Catalog (lit. cat.# 55980) for a complete product listing.

the tailing of this compound is inherent with the liquid phase and does not appear to affect linearity for the limited ranges used in pesticide calibrations. However, when the tailing peaks are caused by nonvolatile contaminants deposited from sample extracts, the poor chromatography does affect linearity. The nonvolatile compounds are usually located at the front end of the column or guard column. The contaminated section of column can be removed by cutting off a piece of the inlet end of the capillary column or rinsing the column with solvent. If dirty samples are being analyzed and tailing of compounds is a problem, remove one loop of the guard column. This is usually enough to eliminate the tailing. If the analytical column is affected, the column can be rinsed with solvent to remove nonvolatile compounds. Using methylene chloride, rinse the column from back to front.

The linearity of ECDs for a 16- to 100-fold concentration range is sufficient to pass linearity requirements. Linearity for ECDs is affected by the flow rate of the make-up gas, nitrogen or argon/methane. To set the flow rate of the make-up gas, run a calibration curve including α -BHC and methoxychlor. Using response factors, calculate the percent relative standard deviation (RSD) of each compound. Set the make-up gas flow rate so the percent RSD of these two compounds is the same. An increase in make-up gas flow will improve the linearity of α -BHC but make linearity worse for methoxychlor. The remaining pesticides will exhibit linear curves once the make-up gas has been set to give good linearity for α -BHC and methoxychlor.

Because several of the pesticide compounds, most notably endrin, react with hot metal surfaces, cold on-column or direct injections are suggested. With certain GCs this becomes even more important if the sample is exposed to metal seals.

Cold On-Column Injections

In cold on-column injections, the needle is inserted directly into the column and the sample extract is deposited. On-column injections work extremely well for relatively clean samples. If contamination levels are low, and not too much nonvolatile residue is present (lipids, hydrocarbons, sulfurs, etc.) in the sample extracts, then on-column injections provide the best detectability and linearity, and narrowest peak width.

On-column injections are best suited for the analysis of water sample extracts, where analyte concentration levels are usually low and the amount of non-volatile material is relatively small. Both small and large volumes can be injected on-column, with the large-volume injections being even more sensitive to non-volatile residue. Conventional on-column injections are typically less than 1 μ L, and require the use of 0.53mm ID columns. Large-volume, on-column injections are typically 10 μ L to 100 μ L and require the use of a pre-column to eliminate the solvent. Several suppliers now offer autosamplers that permit both types of on-column injections. These systems are worth considering if you analyze relatively clean sample extracts. However, they generally only provide acceptable results for the drinking water methods (US EPA Method 500 series). If used for solid and biota extracts, the systems would require frequent maintenance.

Direct Injections

Direct injections are made by injecting the sample extract into a hot injection port liner. The extract vaporizes and the carrier gas transfers the analytes to the GC column, where they are refocused. In conventional direct injection ports using a Uniliner[®] glass liner, the column is connected to it by means of a press-tight seal at the bottom of the liner. This type of injection port set-up eliminates contact of analytes with the active metal surfaces below the bot-

The injection port is where a majority of analytical problems occur in the analysis of pesticides. The main problem is the cleanliness and inertness of the injection port with which the sample extract comes into contact.

For tech support, call
800-356-1688, ext. 4
(814-353-1300, ext. 4)

On-column or direct injections are suggested because several of the pesticide compounds, most notably endrin, react with hot metal surfaces. With certain GCs, this becomes even more important if the sample is exposed to metal seals.

Figure 2: A press-tight seal connects the liner to the column.

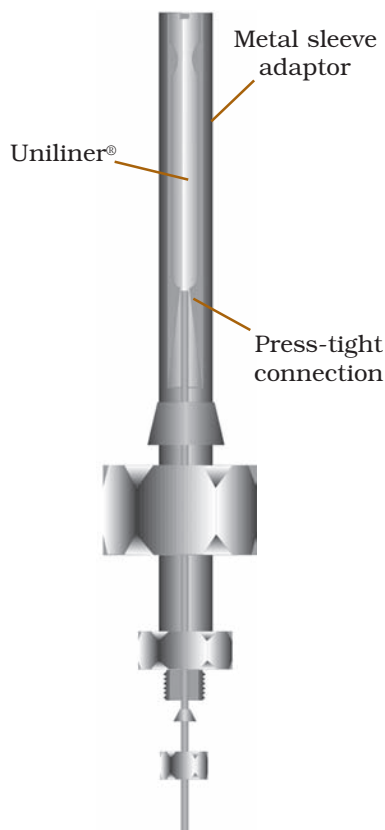

tom of the liner (Figure 2). The benefits of using this type of injection are that upwards of 3 μ L to 4 μ L of sample can be injected, and injection port discrimination is reduced.

A split/splitless injection port also may be adapted for direct injections using Uniliner® liners. In this mode of operation, the split/splitless injection port split valve (purge valve) must be turned off. Additionally, it is beneficial to make a leak-free connection (press-tight seal) between the liner and the column. Refer to the steps presented in the supplied product information sheet, or found in our catalog, to install a Press-Tight® connector. It is also helpful to use graphite ferrules for this connection because the Vespel® ferrules may cause the column connection to fracture if overtightened. Finally, before inserting the column into the connector, dip the end of the column into a vial of methanol for 30 seconds. This causes the polyimide coating on the column to swell, resulting in a better seal.

A third direct injection technique used for pesticide analysis involves large-volume injections into a cold injection port. The injected solvents and compounds are cold-trapped on the injection port liner walls. The injection port is heated to about the boiling point of the solvent, and the solvent is vented out of the system. The vent is turned off and the injection port is heated rapidly, allowing the trapped analytes to transfer from the liner to the inlet end of the analytical column.

Pesticide methods generally require a second column analysis for confirmation, to give a higher degree of confidence in reported analytes. For dual-column analyses, we recommend that these injections be made into a single injection port and split onto two columns using a glass “Y” fitting (Figure 3). Although there are alternative ways to set-up a dual-column system, this method provides the best reproducibility, while achieving the required detection limits and minimizing instrument maintenance.

Splitless Injections

Splitless injection involves operating a split injection port with the split valve (purge valve) closed during the injection, allowing all the carrier gas to be directed into the column. The split valve remains closed for a short time (30 sec. to 2 min.) after the injection in an attempt to transfer as much of the sample extract as possible from the injection port onto the column. After this splitless hold, the purge vent is opened, and the remaining solvent and non-

transferred sample are vented out of the injection port. The purge vent should have a carbon trap attached to remove any pesticides and other organic compounds before being vented into the laboratory.

Splitless injection requires optimization of the purge time to ensure that the maximum amount of analyte is transferred to the column, and minimizes the amount of solvent. Generally, the purge time is determined by maximizing the area count of the last eluting analyte. For additional information, please contact Restek's technical service and ask for the technical guide *Operating Hints for Split/Splitless Injectors* (lit. cat.#59880).

Splitless injection is prone to inertness problems because of the residence time

Figure 3: “Y” fitting provides best dual-column system connection

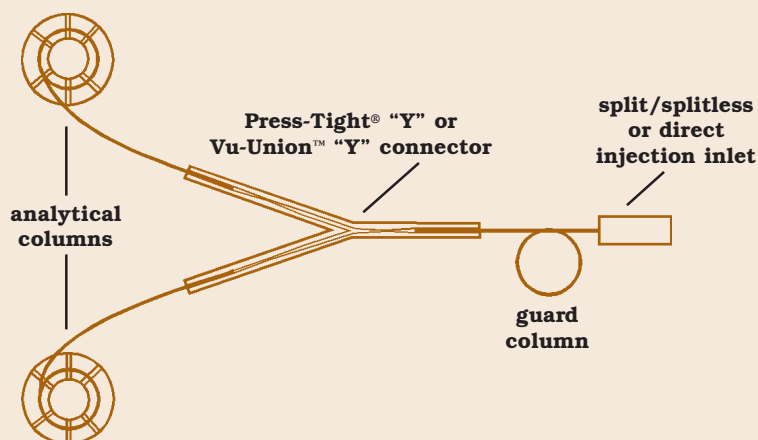

and exposure of the analytes, such as endrin, to the metal surfaces outside the glass liner. During injection, the vapor cloud expands outside the glass liner, exposing reactive analytes to metal surfaces. Endrin and 4,4'-DDT are used as indicator compounds for active sites. The most common active area in the injection port is the bottom of the injection port, below the liner. The vapor cloud expands past the column and comes in contact with the metal disk (inlet seal) below the liner. These inlet seals should be cleaned or replaced during routine maintenance. The use of a gold or Silcosteel®-treated inlet seal will provide greater inertness.

Resolution Discussion

For many years, environmental laboratories have struggled with various chlorinated pesticide analytical methods. Not only do the labs keep track of resolution requirements and breakdown performance criteria, but they also analyze extracts that usually contain high-boiling contaminants. While these contaminants don't always appear in the GC/ECD chromatogram, they can cause shifts in retention time, elevated baselines, and target compound breakdown. Many laboratories have used cyanopropyl capillary column stationary phases (1701 columns), which may provide the best resolution between target compounds, but have several limitations:

1. 1701-type columns are prone to on-column breakdown of DDT and methoxychlor as a result of degradation of the stationary phase. While each column can be tested for this before leaving the manufacturer, it is no guarantee that this problem will not arise after the column has been subjected to sample analyses. The problem seems to be related to the basic nature of the cyano group, and does not appear to be easily solved.
2. 1701-type columns have relatively low maximum operating temperatures, which prohibit final oven temperature ramps high enough to remove the higher-boiling oils commonly found in pesticide and PCB extracts. This procedure, commonly referred to as baking out, is used by many laboratories to eliminate or reduce the levels of heavier hydrocarbons at the end of each analysis, providing that the columns can be heated to higher levels than those used in the analysis itself.

Several phenyl/methyl phases have also been used for this analysis, including a 5% phenyl/35% phenyl/50% phenyl phase. While each of these phases has a higher maximum temperature and is less reactive, as compared to the cyanopropyl phases, they all have target compounds that coelute to some extent. The specific compounds that coelute vary based on the percent of phenyl composition, but each column has at least one coelution. This results in additional work for the laboratory, and in some cases, requires that both compounds be reported, even though only one may be present.

While using two phenyl-phase columns in a dual-column system allows baking-out of the system between analyses, the phenyl-phase columns are more prone to coelution of the chlorinated pesticides than the cyanopropyl-phase columns. This has kept the cyanopropyl-phase columns in demand for pesticide analysis, despite their limitations—until now.

The development of the Rtx®-CLPesticides and the Rtx®-CLPesticides2 columns has simplified the choice. These columns are capable of baseline resolution of the 22 common chlorinated pesticides as listed in US EPA Methods 8081, CLP, and 608. Each column is available in 0.25mm, 0.32mm, and 0.53mm IDs, and has been optimized for ECD analysis. Both feature almost zero bleed after conditioning. In addition to their separating ability, the Rtx®-CLPesticides columns can be heated to temperatures previously only tolerated by phenyl-phase columns. The maximum temperature of the Rtx®-

Rtx[®]-CLPesticides and Rtx[®]-CLPesticides2 columns baseline resolve all 22 chlorinated pesticides (US EPA Methods 8081, CLP, and 608) in under 25 minutes. See page 18 for ordering information.

Figures 6–9 are shown on pages 16 and 17. Product listings begin on page 18.

CLPesticides column and the Rtx[®]-CLPesticides2 column is 330°C, making it similar to the 5% phenyl Rtx[®]-5 column.

When using cyanopropyl-phase or phenyl-phase columns, laboratories typically must calibrate using 5-point curves, injecting mix A and mix B compounds separately because the target compounds coelute. Because no coelution problems occur with the Rtx[®]-CLPesticides columns, the mixes can be combined. This eliminates the need for at least 5 injections during calibration of the instrument, and may free a minimum of 2.5 hours a day to analyze more samples. (The CLP method, however, mandates the separate calibration sequence—it is the only method to do so.) Restek provides the calibration standards as a single mix for laboratories wishing to use only one calibration mix in their calibration curves (see the product listings beginning on page 18 for details).

Although Rtx[®]-CLPesticides columns are available in all three common ID dimensions, we typically recommend using the 0.32mm ID size. This size provides the best combination of capacity and peak width (Figure 4). If your sample extracts are particularly contaminated, you may find that the 0.53mm ID columns allow for longer duration of calibration, because of the large capacity (Figure 5). Columns of 0.25mm ID provide better resolution, but cannot handle contaminated or large samples (Figure 6). In most cases, the 0.32mm ID is the size of choice for this analysis.

When configuring the column pair, use a 5m section of guard tubing to connect the glass “Y” to the injection port. This allows enough of a retention gap so that the sample is evenly split into the two columns. The best flow rates and oven programs are listed on the chromatograms, but it is possible to get a total run time as low as 16 minutes using hydrogen as a carrier gas (Figure 7). Some laboratories may not be comfortable using hydrogen, though it affords a shorter run time. In any event, both helium and hydrogen work well as a carrier gas when using Rtx[®]-CLPesticides columns for this analysis.

The separations of US EPA Method 508 pesticides (Figure 8) and US EPA Method 8151 herbicides (Figure 9) also are shown because these analyses typically are run on the same instrument as the chlorinated pesticides already shown. It is important to note that Rtx[®]-CLPesticides columns also exhibit baseline separation for these compounds, except for a few that are not commonly observed. The Rtx[®]-CLPesticides column and the Rtx[®]-CLPesticides2 column combination results in the resolution of all compounds, allowing the use of one column pair and the same instrument flow rate for many different analyses.

Summary

Although the analysis of chlorinated pesticides historically has been one of the more difficult tests performed by environmental testing laboratories, using Restek’s Rtx[®]-CLPesticides columns, coupled with the methods presented in this guide will make your analyses easier. Optimized sample preparation and extract cleanup, the proper injection technique, suitable analytical columns and standards, and accurate quantitation will improve your results and increase your lab’s throughput.

When problems occur, using proper troubleshooting and maintenance techniques can quickly reestablish system integrity. When faced with difficulties in your pesticide or PCB analysis, remember that the majority of problems occur during the sample preparation and cleanup step, or at the injection port of the GC. If you are still having difficulties with your analysis after following the steps in this guide, please contact Restek’s technical service at 800-356-1688, ext. 4, and we will be happy to help you.

Figure 4

0.32mm ID columns provide best capacity and resolution of all 22 pesticides used in US EPA Method 8081.

Rtx®-CLPesticides

30m, 0.32mm ID, 0.50 μ m (cat.# 11139)

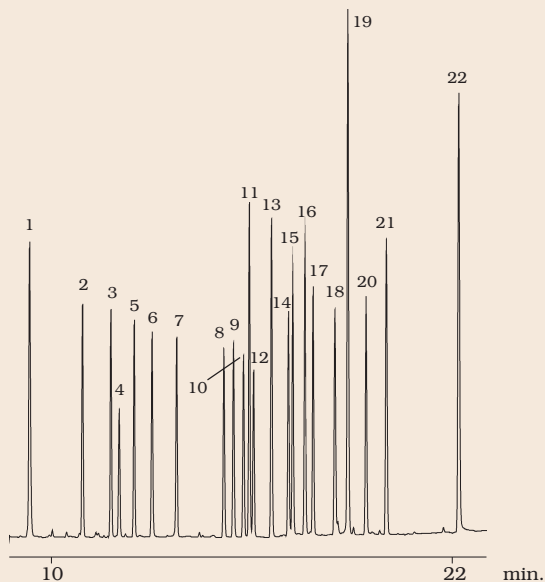
**Rtx®-CLPesticides2**

30m, 0.32mm ID, 0.25 μ m (cat.# 11324)

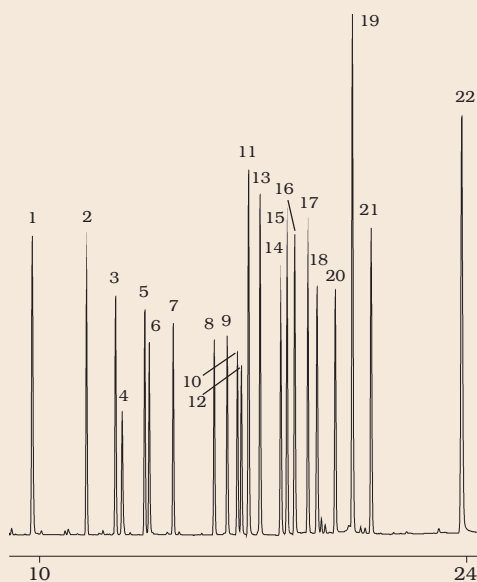

1. 2,4,5,6-tetrachloro-m-xylene
2. α -BHC (α -HCH)
3. γ -BHC (lindane)
4. β -BHC (β -HCH)
5. δ -BHC (δ -HCH)
6. heptachlor
7. aldrin
8. heptachlor epoxide
9. γ -chlordane
10. α -chlordane
11. 4,4'-DDE
12. endosulfan I
13. dieldrin
14. endrin
15. 4,4'-DDD
16. endosulfan II
17. 4,4'-DDT
18. endrin aldehyde
19. methoxychlor
20. endosulfan sulfate
21. endrin ketone
22. decachlorobiphenyl

On-column concentration: 16-160pg organochloride pesticide mix AB#2 (cat.# 32292); **Oven temp.:** 120°C (hold 1 min.) to 300°C (hold 10 min.) @ 9°C/min.; **Inj. port:** Direct, Uniliner® sleeve (cat.# 20335), at 200°C; **Detector:** ECD, 300°C with Anode Purge; **Dead time:** 1.9 min.; **Head pressure:** 8.7psi (constant); **Flow rate:** 1.3mL/min. @ 120°C, Helium.

Figure 5

0.53mm ID columns for the best analysis of contaminated pesticide samples (US EPA Method 8081).

Rtx®-CLPesticides

30m, 0.53mm ID, 0.50 μ m (cat.# 11140)

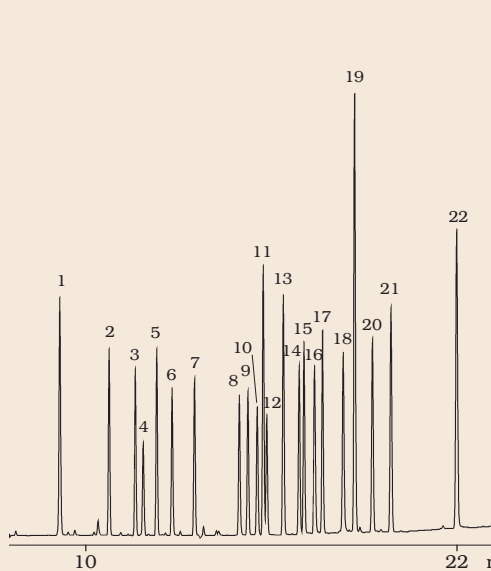
**Rtx®-CLPesticides2**

30m, 0.53mm ID, 0.42 μ m (cat.# 11340)

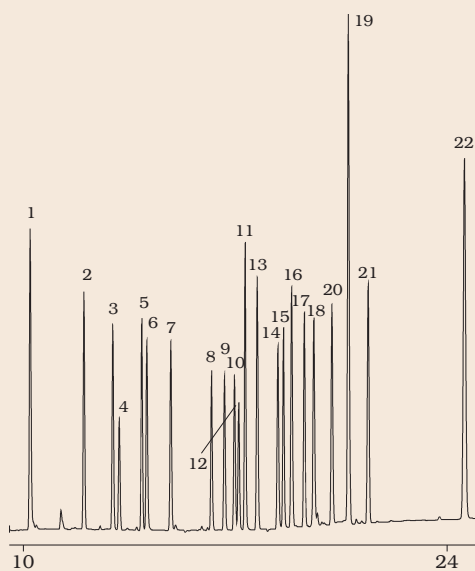

1. 2,4,5,6-tetrachloro-m-xylene
2. α -BHC (α -HCH)
3. γ -BHC (lindane)
4. β -BHC (β -HCH)
5. δ -BHC (δ -HCH)
6. heptachlor
7. aldrin
8. heptachlor epoxide
9. γ -chlordane
10. α -chlordane
11. 4,4'-DDE
12. endosulfan I
13. dieldrin
14. endrin
15. 4,4'-DDD
16. endosulfan II
17. 4,4'-DDT
18. endrin aldehyde
19. methoxychlor
20. endosulfan sulfate
21. endrin ketone
22. decachlorobiphenyl

On-column concentration: 16-160pg organochloride pesticide mix AB#2 (cat.# 32292); **Oven temp.:** 120°C (hold 1 min.) to 300°C (hold 10 min.) @ 9°C/min.; **Inj. port:** Direct, Uniliner® sleeve (cat.# 20335), at 200°C; **Detector:** ECD, 300°C with Anode Purge; **Dead time:** 1.9 min.; **Head pressure:** 3psi (constant); **Flow rate:** 2.83mL/min. @ 120°C, Helium.

Figure 6

Smaller ID provides better detection limits. 0.25mm ID columns provide better signal-to-noise ratio. (US EPA Method 8080).

Rtx[®]-CLPesticides

30m, 0.25mm ID, 0.25 μ m (cat.# 11123)

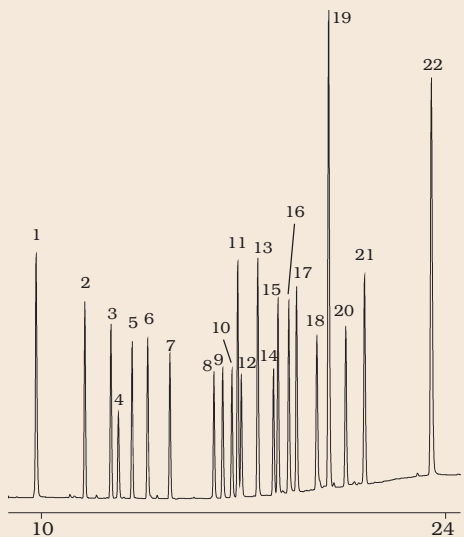
**Rtx[®]-CLPesticides2**

30m, 0.25mm ID, 0.20 μ m (cat.# 11323)

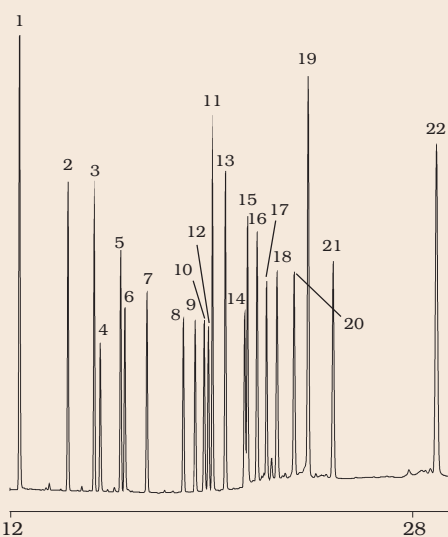

1. 2,4,5,6-tetrachloro-m-xylene
2. α -BHC (α -HCH)
3. γ -BHC (lindane)
4. β -BHC (β -HCH)
5. δ -BHC (δ -HCH)
6. heptachlor
7. aldrin
8. heptachlor epoxide
9. γ -chlordane
10. α -chlordane
11. 4,4'-DDE
12. endosulfan I
13. dieldrin
14. endrin
15. 4,4'-DDD
16. endosulfan II
17. 4,4'-DDT
18. endrin aldehyde
19. methoxychlor
20. endosulfan sulfate
21. endrin ketone
22. decachlorobiphenyl

On-column concentration: 16-160pg organochloride pesticide mix AB#2 (cat.# 32292); **Oven temp.:** 120°C (hold 1 min.) to 300°C (hold 3 min.) @ 8.5°C/min.; **Inj. port:** Direct, Uniliner[®] sleeve (cat.# 20335), at 200°C; **Detector:** ECD, 300°C with Anode Purge; **Dead time:** 2.4 min.; **Head pressure:** 11.2psi (constant); **Flow rate:** 0.64mL/min. @ 120°C, Helium.

Figure 7

Fast screening of pesticides using hydrogen gas flow with 15m columns.

Rtx[®]-CLPesticides

15m, 0.32mm ID, 0.50 μ m (cat.# 11136)

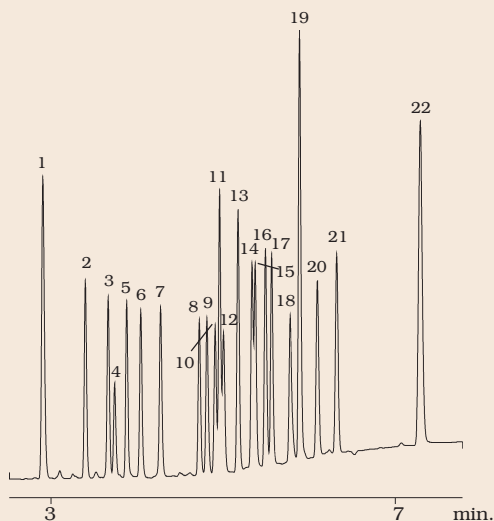
**Rtx[®]-CLPesticides2**

15m, 0.32mm ID, 0.25 μ m (cat.# 11321)

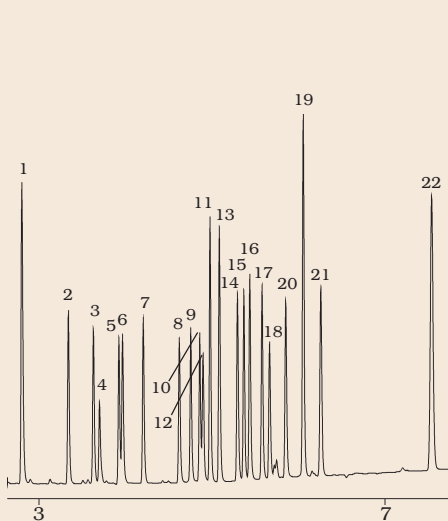

1. 2,4,5,6-tetrachloro-m-xylene
2. α -BHC (α -HCH)
3. γ -BHC (lindane)
4. β -BHC (β -HCH)
5. δ -BHC (δ -HCH)
6. heptachlor
7. aldrin
8. heptachlor epoxide
9. γ -chlordane
10. α -chlordane
11. 4,4'-DDE
12. endosulfan I
13. dieldrin
14. endrin
15. 4,4'-DDD
16. endosulfan II
17. 4,4'-DDT
18. endrin aldehyde
19. methoxychlor
20. endosulfan sulfate
21. endrin ketone
22. decachlorobiphenyl

On-column concentration: 16-160pg organochloride pesticide mix AB#2 (cat.# 32292); **Oven temp.:** 115°C to 280°C (hold 2 min.) @ 29°C/min.; **Inj. port:** Direct, Uniliner[®] sleeve (cat.# 20335), at 200°C; **Detector:** ECD, 300°C with Anode Purge; **Dead time:** 0.73 min.; **Head pressure:** 4.5psi (constant); **Flow rate:** 1.33mL/min. @ 120°C, Hydrogen.

Figure 8

0.32mm ID Rtx®-CLPesticides and Rtx®-CLPesticides2 columns provide good separation of Method 508.1 pesticides.

Rtx®-CLPesticides
30m, 0.32mm ID, 0.50µm (cat.# 11139)

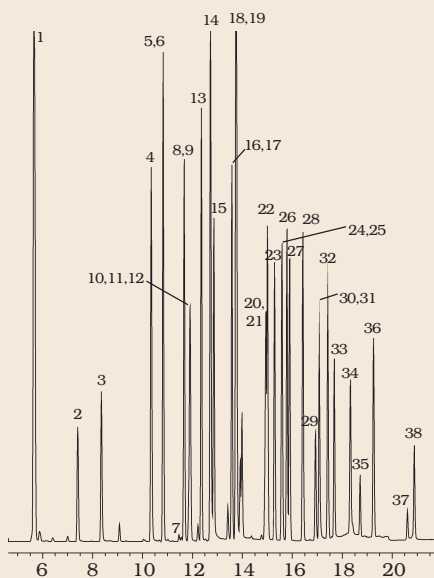

Rtx®-CLPesticides2
30m, 0.32mm ID, 0.25µm (cat.# 11324)

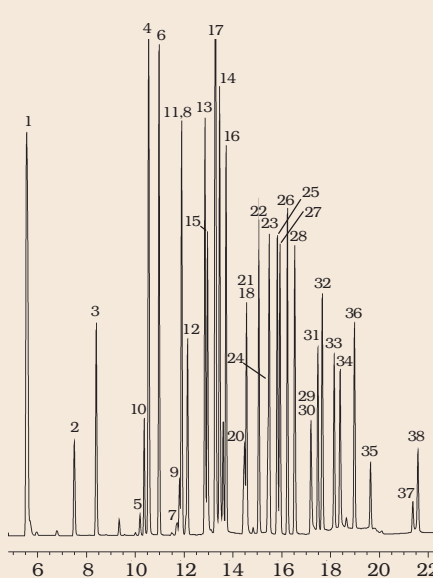

1. hexachloropentadiene	1000 pg/µL
2. etridiazole	500
3. chlorneb	500
4. hexachlorobenzene	1000
5. propachlor	100
6. α-BHC (α-HCH)	500
7. simazine	100
8. γ-BHC (γ-HCH)	5000
9. atrazine	1000
10. trifluralin	100
11. pentachloronitrobenzene	100
12. β-BHC (β-HCH)	100
13. δ-BHC (δ-HCH)	100
14. metribuzin	100
15. heptachlor	1000
16. aldrin	1000
17. chlorothalonil	1000
18. 4,4'-dibromobiphenyl	1000
19. alachlor	1000
20. metalachlor	100
21. DCPA (decthal)	100
22. heptachlor epoxide	5000
23. γ-chlordane	100
24. cyanazine	100
25. α-chlordane	100
26. 4,4'-DDE	100
27. endosulfan I	100
28. dieldrin	500
29. endrin	100
30. chlorobenzilate	100
31. 4,4'-DDD	100
32. endosulfan II	100
33. 4,4'-DDT	100
34. endrin aldehyde	100
35. methoxychlor	100
36. endosulfan sulfate	100
37. cis-permethrin	1000
38. trans-permethrin	1000

On-column concentration: see peak ID list; **Oven temp.:** 120°C (hold 1 min.) to 300°C (hold 10 min.) @ 9°C/min.; **Inj. port:** Direct, Uniliner® sleeve (cat.# 20335), at 200°C; **Detector:** ECD, 300°C with Anode Purge; **Dead time:** 1.7 min.; **Head pressure:** 12psi (constant); **Flow rate:** 1.4mL/min. @ 120°C, Helium.

Figure 9

Primary herbicides are well-resolved (US EPA Method 8151).

Rtx®-CLPesticides
30m, 0.32mm ID, 0.50µm (cat.# 11139)

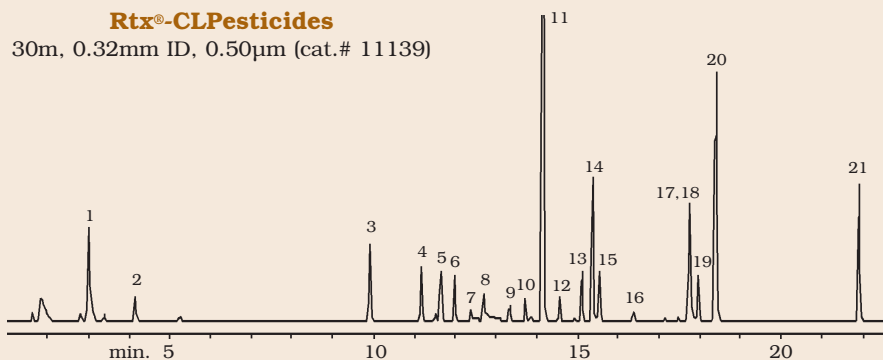

Rtx®-CLPesticides2
30m, 0.32mm ID, 0.25µm (cat.# 11324)

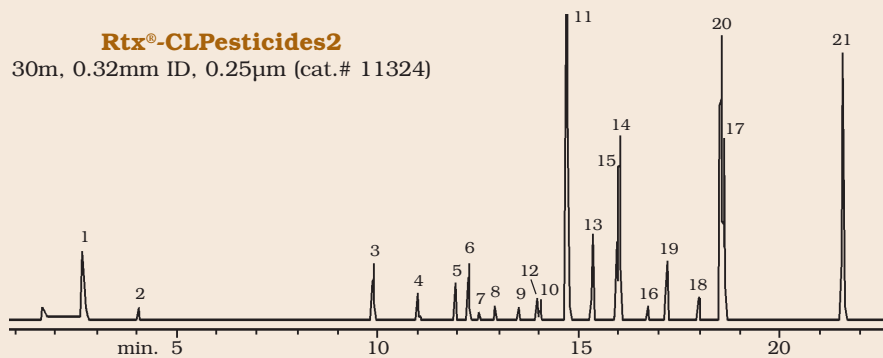

1. dalapon methyl ester	1000 pg/µL
2. 1,4-dichlorobenzene	500 µL
3. 3,5-dichlorobenzoic acid methyl ester	500
4. 4-nitroanisole	500
5. DCAA methyl ester	500
6. dicamba methyl ester	50
7. MCPP methyl ester	50000
8. MCPA methyl ester	50000
9. dichloroprop methyl ester	200
10. 2,4-D methyl ester	200
11. pentachloroanisole	200
12. 4,4'-dibromooctafluorobiphenyl	50
13. 2,4,5-TP (silvex) methyl ester	50
14. chloramben methyl ester	500
15. 2,4,5-T methyl ester	50
16. 2,4-DB methyl ester	200
17. picloram methyl ester	500
18. bentazon methyl ester	500
19. dinoseb methyl ester	150
20. DCPA dimethyl ester	500
21. acifluorfen methyl ester	500

On-column concentration: see peak ID list; **Oven temp.:** 90°C (hold 1 min.) to 300°C (hold 10 min.) @ 9°C/min.; **Inj. port:** Direct, Uniliner® sleeve (cat.# 20335), at 200°C; **Detector:** ECD, 300°C with Anode Purge; **Dead time:** 1.86 min.; **Head pressure:** 12psi (constant); **Flow rate:** 1.2mL/min. @ 120°C, Helium.

Product Listings:

For customer service, call
800-356-1688, ext. 3
 (814-353-1300, ext. 3)

Rtx[®]-CLPesticides Column

ID	df (µm)	temp. limits	stable to	15-Meter	30-Meter
0.25mm	0.25	-60 to 310/330°C	340°C	11120	11123
0.32mm	0.50	-60 to 310/330°C	340°C	11136	11139
0.53mm	0.50	-60 to 310/330°C	340°C	11137	11140

Rtx[®]-CLPesticides2 Column

ID	df (µm)	temp. limits	stable to	15-Meter	30-Meter
0.25mm	0.20	-60 to 310/330°C	340°C	11320	11323
0.32mm	0.25	-60 to 310/330°C	340°C	11321	11324
0.53mm	0.42	-60 to 310/330°C	340°C	11337	11340

Rtx[®]-CLPesticides Kits

(Note: Columns are not preconnected in the following kits.)

0.53mm ID Rtx[®]-CLPesticides Kit

Includes:

30m, 0.53mm ID, 0.50µm Rtx[®]-CLPesticides column
 30m, 0.53mm ID, 0.42µm Rtx[®]-CLPesticides2 column
 Universal Angled "Y" Press-Tight[®] Connector
 5m, 0.53mm ID IP Deactivated Guard Column

cat.# 11197/kit

0.32mm ID Rtx[®]-CLPesticides Kit

Includes:

30m, 0.32mm ID, 0.50µm Rtx[®]-CLPesticides
 30m, 0.32mm ID, 0.25µm Rtx[®]-CLPesticides2
 Universal Angled "Y" Press-Tight[®] Connector
 5m, 0.32mm ID IP Deactivated Guard Column

cat.# 11198/kit

0.25mm ID Rtx[®]-CLPesticides Kit

Includes:

30m, 0.25mm ID, 0.25µm Rtx[®]-CLPesticides
 30m, 0.25mm ID, 0.20µm Rtx[®]-CLPesticides2
 Universal Angled "Y" Press-Tight[®] Connector
 5m, 0.32mm ID IP Deactivated Guard Column

cat.# 11199/kit

Analytical Reference Materials

Save \$ by ordering these reference materials with your Rtx®-CLPesticides Kits! Just add the appropriate suffix # to the Rtx®-CLPesticides Kit catalog number.

Pesticide Mix AB#1: cat.# 32291 Suffix #-530

Pesticide Mix AB#2: cat.# 32292 Suffix #-535

Method 8080 Organochlorine Pesticides

Organochlorine Pesticide Mix AB #1

aldrin	dieldrin
α-BHC	endosulfan I
β-BHC	endosulfan II
δ-BHC	endosulfan sulfate
γ-BHC (lindane)	endrin
α-chlordane	endrin aldehyde
γ-chlordane	endrin ketone
4,4'-DDD	heptachlor
4,4'-DDE	heptachlor epoxide (B)
4,4'-DDT	methoxychlor

200µg/mL ea. in hexane/toluene (1:1),
1mL/ampul

w/data pack

Each	32291	32291-500
5-pk.	32291-510	32291-520
10-pk.		32391

Organochlorine Pesticide Mix AB #2

		µg/mL			µg/mL
aldrin	8	dieldrin	16		
α-BHC	8	endosulfan I	8		
β-BHC	8	endosulfan II	16		
δ-BHC	8	endosulfan sulfate	16		
γ-BHC (lindane)	8	endrin	16		
α-chlordane	8	endrin aldehyde	16		
γ-chlordane	8	endrin ketone	16		
4,4'-DDD	16	heptachlor	8		
4,4'-DDE	16	heptachlor epoxide (B)	8		
4,4'-DDT	16	methoxychlor	80		

In hexane/toluene (1:1), 1mL/ampul

w/data pack

Each	32292	32292-500
5-pk.	32292-510	32292-520
10-pk.		32392

For tech support, call
800-356-1688, ext. 4
(814-353-1300, ext. 4)

Sample Preparation

Resprep™-C18 and -C8 SPE Disks

Meets requirements for EPA Methods 525.1, 506, 550.1, and 549.1.

Resprep™-C18-47: cat.# 24004, 20-pack

Resprep™-C8-47: cat.# 24048, 24-pack

Resprep™ Resin SPE Disk

Meets requirements for EPA Methods 515.2 and 553.

Resprep™ Resin SPE Disk: cat.# 26023, 20-pack

Resprep™ SPE Cartridges

(All cartridges are polypropylene and have polyethylene frits unless otherwise noted):

C18	6mL	500mg	30-pk.	cat.# 24052
	6mL	1000mg	30-pk.	cat.# 24051
Florisil®	3mL	500mg	50-pk.	cat.# 24031
	3mL	500mg	50-pk.	cat.# 24032*
	6mL	1000mg	30-pk.	cat.# 24034
	6mL	500mg	30-pk.	cat.# 26086**
	6mL	1000mg	30-pk.	cat.# 26085**
Silica	3mL	500mg	50-pk.	cat.# 24035
	3mL	500mg	50-pk.	cat.# 24036*
	6mL	1000mg	30-pk.	cat.# 24038
Carbon	3mL	250mg	50-pk.	cat.# 26088
	6mL	500mg	30-pk.	cat.# 26087

*Stainless steel frits

**Glass cartridges with PTFE frits.

Method 608 Organochlorine Pesticides & PCBs

Method 608 Calibration Mix

aldrin	dieldrin
α -BHC	endosulfan I
β -BHC	endosulfan II
δ -BHC	endosulfan sulfate
γ -BHC (lindane)	endrin
4,4'-DDD	endrin aldehyde
4,4'-DDE	heptachlor
4,4'-DDT	heptachlor epoxide (B)

200 μ g/mL ea. in hexane: toluene (1:1)

1mL/ampul

	w/data pack	
Each	32022	32022-500
5-pk.	32022-510	32022-520
10-pk.	32122	

Method 608 Complete Kit

32022: Method 608 Calibration Mix
 32006: Aroclor[®] 1016
 32007: Aroclor[®] 1221
 32008: Aroclor[®] 1232
 32009: Aroclor[®] 1242
 32010: Aroclor[®] 1248
 32011: Aroclor[®] 1254
 32012: Aroclor[®] 1260
 32005: Toxaphene
 32021: Chlordane (technical)

Contains 1mL ea. of these products.

	Kit	
	Kit	w/data pack
	32060	32160

CLP GPC Calibration Mix

CLP GPC Calibration Mix

bis(2-ethylhexyl)phthalate	10mg/mL
corn oil	250mg/mL
methoxychlor	2.0mg/mL
perylene	0.2mg/mL
sulfur	0.8mg/mL

1mL/ampul:

	10-Pack	
	Each	w/data pack
	32019	32119

5mL/ampul:

	10-Pack	
	Each	w/data pack
	32023	32123

Revised GPC Calibration Mix

bis(2-ethylhexyl)phthalate	5mg/mL
corn oil	250mg/mL
methoxychlor	1.0mg/mL
perylene	0.2mg/mL
sulfur	0.8mg/mL

1mL/ampul:

	10-Pack	
	Each	w/data pack
	32041	32141

5mL/ampul:

	10-Pack	
	Each	w/data pack
	32042	32142

Pesticide Surrogate Solutions

Dibutylchlorendate Mix

200 μ g/mL in acetone

1mL/ampul:

	w/data pack	
Each	32025	32025-500
5-pk.	32025-510	32025-520
10-pk.	32125	

5mL/ampul:

	w/data pack	
Each	32026	32026-500
5-pk.	32026-510	32026-520
10-pk.	32126	

2,4,5,6-Tetrachloro-m-xylene Mix

200 μ g/mL in acetone

1mL/ampul:

	w/data pack	
Each	32027	32027-500
5-pk.	32027-510	32027-520
10-pk.	32127	

5mL/ampul:

	w/data pack	
Each	32028	32028-500
5-pk.	32028-510	32028-520
10-pk.	32128	

Decachlorobiphenyl Mix

200 μ g/mL in acetone

1mL/ampul:

	w/data pack	
Each	32029	32029-500
5-pk.	32029-510	32029-520
10-pk.	32129	

5mL/ampul:

	w/data pack	
Each	32030	32030-500
5-pk.	32030-510	32030-520
10-pk.	32130	

Pesticide Surrogate Mix

decachlorobiphenyl

2,4,5,6-tetrachloro-m-xylene

200 μ g/mL ea. in acetone, 1mL/ampul

	w/data pack	
Each	32000	32000-500
5-pk.	32000-510	32000-520
10-pk.	32100	

For tech support, call
800-356-1688, ext. 4
 (814-353-1300, ext. 4)

Aroclor[®], Toxaphene, and Chlordane Solutions

1000µg/mL in hexane 1mL/ampul	Each	Each w/ data pack	5pk.	5pk. w/ data pack	10pk. w/ data pack
Aroclor [®] 1016	32006	32006-500	32006-510	32006-520	32106
Aroclor [®] 1221	32007	32007-500	32007-510	32007-520	32107
Aroclor [®] 1232	32008	32008-500	32008-510	32008-520	32108
Aroclor [®] 1242	32009	32009-500	32009-510	32009-520	32109
Aroclor [®] 1248	32010	32010-500	32010-510	32010-520	32110
Aroclor [®] 1254	32011	32011-500	32011-510	32011-520	32111
Aroclor [®] 1260	32012	32012-500	32012-510	32012-520	32112
Aroclor [®] 1016/1260	32039	32039-500	32039-510	32039-520	32139

200µg/mL in isooctane 1mL/ampul	Each	Each w/ data pack	5pk.	5pk. w/ data pack	10pk. w/ data pack
Aroclor [®] 1016	32064	32064-500	32064-510	32064-520	32164
Aroclor [®] 1221	32065	32065-500	32065-510	32065-520	32165
Aroclor [®] 1232	32066	32066-500	32066-510	32066-520	32166
Aroclor [®] 1242	32067	32067-500	32067-510	32067-520	32167
Aroclor [®] 1248	32068	32068-500	32068-510	32068-520	32168
Aroclor [®] 1254	32069	32069-500	32069-510	32069-520	32169
Aroclor [®] 1260	32070	32070-500	32070-510	32070-520	32170

1000µg/mL in hexane 1mL/ampul	Each	Each w/ data pack	5pk.	5pk. w/ data pack	10pk. w/ data pack
chlordane (technical)	32021	32021-500	32021-510	32021-520	32121
toxaphene	32005	32005-500	32005-510	32005-520	32105

5000µg/mL in isooctane 1mL/ampul	Each	Each w/ data pack	5pk.	5pk. w/ data pack	10pk. w/ data pack
chlordane (technical)	32072	32072-500	32072-510	32072-520	32172
toxaphene	32071	32071-500	32071-510	32071-520	32171

PCB Kit #1

1000µg/mL in hexane, 1mL/ampul
1 ea. of 32006, 32007, 32008, 32009, 32010, 32011, and 32012.

Kit	Kit w/data pack
32089	32089-500

PCB Kit #2

200µg/mL in isooctane, 1mL/ampul
1 ea. of 32064, 32065, 32066, 32067, 32068, 32069, and 32070.

Kit	Kit w/data pack
32090	32090-500

Universal "Y" Press-Tight® Connectors

- Split sample flow onto two columns.
- Split a single column flow into two different detectors.
- Perform confirmational analysis with a single injection.

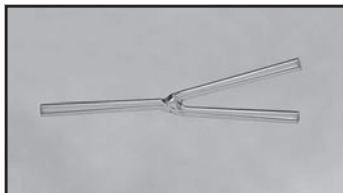

Universal "Y" Press-Tight® Connectors

cat.# 20405 (ea.)

cat.# 20406 (3-pk.)

For Uniliner® direct injection sleeve product information, visit our web site (www.restek.com).

Universal Angled "Y" Press-Tight® Connectors

- Alleviates column-end connection strain.
- Inlet and outlet ends conform to the column radius.
- Perform confirmational analysis with a single injection.

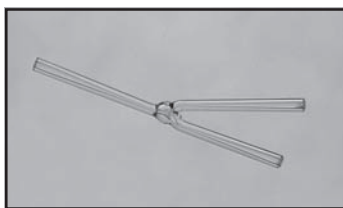

Universal Angled "Y" Press-Tight® Connectors

cat.# 20403 (ea.)

cat.# 20404 (3-pk.)

Thermolite® Septa

- Lowest bleed on FIDs, ECDs, & MSDs.
- Excellent puncturability.
- Preconditioned and ready to use.
- Do not adhere to hot metal surfaces.
- Usable to 340°C inlet temperatures.
- Packaged in non-contaminating tins.

Septum Diameter	25-pk.	50-pk.	100-pk.
5mm ($\frac{3}{16}$ "	20351	20352	20353
6mm ($\frac{1}{4}$ "	20355	20356	20357
7mm	20381	20382	20383
8mm	20370	20371	—
9.5mm ($\frac{3}{8}$ "	20359	20360	20361
10mm	20378	20379	20380
11mm ($\frac{7}{16}$ "	20363	20364	20365
12.5mm ($\frac{1}{2}$ "	20367	20368	20369
17mm	20384	20385	20386
Shimadzu Plug	20372	20373	20374



Contact your Restek representative and order yours today!

Visit **www.restek.com/Contact-Us** to find a distributor or representative.

PATENTS & TRADEMARKS

Restek® patents and trademarks are the property of Restek Corporation. (See www.restek.com/Patents-Trademarks for full list.) Other trademarks appearing in Restek® literature or on its website are the property of their respective owners. The Restek® registered trademarks used here are registered in the United States and may also be registered in other countries.



U.S. • 110 Benner Circle • Bellefonte, PA 16823 • 1-814-353-1300 • 1-800-356-1688 • fax: 1-814-353-1309 • www.restek.com

China • phone: +86-10-5629-6620 • fax: +86-10-5814-3980 • cn.restek.com

France • phone: +33 (0)1 60 78 32 10 • fax: +33 (0)1 60 78 70 90 • www.restek.fr

Germany • phone: +49 (0)6172 2797 0 • fax: +49 (0)6172 2797 77 • www.restekgmbh.de

Italy • phone: +39-02-7610037 • fax: +39-02-70100100 • www.superchrom.it

Japan • phone: +81 (3)6459 0025 • fax: +81 (3)6459 0025 • e-mail: restekjapan@restek.com

UK • phone: +44 (0)1494 563377 • fax: +44 (0)1494 564990 • www.thamesrestek.co.uk

Lit. Cat.# 59892A

© 1999 Restek Corporation. All rights reserved.
Printed in the U.S.A.

