

Installation Instruction for ProfIC Vario 6 Anion

The ProfIC Vario 6 Anion is a Professional IC Vario system with Inline Dilution and Inline Ultrafiltration for the fully automatic determination of anions or cations with sequential suppression in very high concentrations in matrices containing particles. This system enables users to dilute the sample and eliminate bacteria or inorganic particles prior to the analysis.



Table of contents

1.	Delivery Package	2
	IC	2
	Detector	2
	Sample processor	2
	Accessories	2
	Optional	2
2.	Installation	2
2.1.	Installation of the software	2
2.2.	Accessory Kit: Vario/Flex Basic (6.5000.000)	2
2.3.	Accessory Kit: Vario/Flex ONE (6.5000.010)	2
2.4.	858 Professional Sample Processor	2
2.4.1.	Liquid Handling Station (LQH Station)	3
2.4.1.1.	Rinsing unit	3
2.4.1.2.	Dilution unit and 800 Dosino	3
2.4.2.	Ultrafiltration cell	4
2.5.	Interconnection of devices	4
2.6.	940 Professional IC Vario	5
3.	MagIC Net	5
3.1.	Configuration	5
3.2.	Method adjustment	6
3.3.	Purge of the system	7
3.4.	User defined determination	7
4.	Exemplary measurement	8
5.	Optional equipment	9
5.1.	Eluent Production Module	9
5.2.	Alternative MSM rinsing and regeneration methods	9

1. Delivery Package

Delivered with ProfIC Vario 6 Anion package:

Nr	Article no.	Article designation
IC		
1	2.940.1500	Professional IC Vario ONE/SeS/PP
Detector		
1	2.850.9010	IC Conductivity Detector
Sample processor		
1	2.858.0020	Professional Sample Processor - Pump
Accessories		
1	2.741.0010	741 Magnetic Stirrer
1	2.800.0010	800 Dosino
1	6.5330.120	IC Equipment: Inline Dilution
1	6.5330.110	IC Equipment: Inline Ultrafiltration
Optional		
1	6.6059.302	MagIC Net 3.0 Professional CD – 1 license
1	6.6059.303	MagIC Net 3.0 Multi – 3 licenses
1	6.2041.760	Sample rack 54 x 11 mL + 1 x 300 mL
1	6.2041.440	Sample rack 148 x 11 mL + 3 x 300 mL
1	6.2743.050	Sample tubes 11 mL
1	6.2743.070	Stopper with perforation
1	6.1030.420	Metrosep A Supp 15 - 150/4.0
1	6.1030.500	Metrosep A Supp 15 Guard/4.0
1	6.1052.420	Metrosep C Supp 1 – 150/4.0
1	6.1052.500	Metrosep C Supp 1 Guard/4.0
1	6.2842.200	MSM-HC Rotor C
1	6.2832.000	MSM Rotor A
1	6.2842.000	MSM-HC Rotor A
1	6.2844.000	MSM-LC Rotor A
1	6.2842.020	Adapter Vario to MSM and MSM-LC
1	2.941.0010	Eluent Production Module
1	2.800.0010	800 Dosino
1	6.3032.150	Dosing Unit 5 mL
1	6.2744.080	M6 thread / UNF 10/32 coupling

2. Installation

Following is a detailed description of how to install ProfIC Vario 6 Anion.

We strongly recommend that the individual steps are carried out in the order given below.

2.1. Installation of the software

All programs must be shut down first. Make sure no Metrohm instrument is connected to the PC. Install MagIC Net with the help of the MagIC Net - CD. The Microsoft Installation Wizard is accepted and executed. All the standard directories proposed by the program should be accepted. Restart windows.

Now as soon as you connect a new Metrohm instrument via USB connection to the PC, the driver is installed and a window will pop up in MagIC Net, asking you if you'd like to store this device in your configuration. If you do, please answer with yes. The names will be checked later in this installation instruction.

2.2. Accessory Kit: Vario/Flex Basic (6.5000.000)

Using the Accessory Kit Vario/Flex Basic, install the Professional IC Vario. Remove handle, place the detector block in the instrument and connect the detector cable, remove the transport locking screws, connect the leak sensor cable and connect the drainage tubing.

In continuation, set up the waste collector by assembling the cap and screwing it onto the vessel. Then hang the waste collector holder on the side of the IC, so you can observe the droplets coming out of the capillaries later connected to the collector. Attach the waste tube to the vessel and lead it to the waste canister. When the tube is too long, please shorten it, because it is important to have a high level difference for the liquid to drain.

The power cable and USB cable (6.2151.020) are plugged into the rear of the Professional IC Vario. Please don't switch on the instrument yet. This step will follow after the completed installation.

2.3. Accessory Kit: Vario/Flex ONE (6.5000.010)

In the box with the Accessory Kits ONE, you will find all the accessories for setting up the Eluent bottle. Please lead the aspiration tube for the Eluent through the M8 stopper, the earring and the eluent cap. Then fix the white weight (6.2744.210), the adaptor (6.2744.210) and the aspiration filter (6.2821.090) on the eluent aspiration tube, all the while being careful not to touch the filter and its connections with bare hands in order to avoid cross contamination. Also fix the filled adsorber tube on the eluent cap. Please refer to the 940 Professional IC Vario manual for a detailed description.

2.4. 858 Professional Sample Processor

For a detailed description, please refer to the 858 Professional Sample Processor manual. In general, you will have to do the following: Plug in the Swing Head connection

cable and the power supply cable. The controller cable (6.2151.000) is plugged into the plug "Contr." on the 858 and connected to the IC device via USB. The sample processor initializes and lifts its Swing Head, once the IC device it is connected to is recognized by the software. For this, you have to plug the USB cable of the IC into the PC and turn it on. Afterwards, it is possible to mount the retaining plate, the needle and the safety shield (for detailed instructions please refer to the 858 Professional Sample Processor manual).

Please remove one element of the energy chain close to the swing head by using a screwdriver to unfix it. In its place, connect the transfer tubing with holder 2 x M6 / 10 mL (6.1562.130). Then connect one end of the transfer tubing onto the swing arm, where the aspiration tip is connected with the help of the adapter UNF 10/32 outer / M6 inner (6.2744.200).

For the following installations, please shut down the IC again and disconnect the 858 from the power supply.

2.4.1. Liquid Handling Station (LQH Station)

The Liquid Handling Station consists of two function units: The rinsing unit is equipped with a two-pipe system and is used for rinsing the sample tube from the inside and outside. The second unit is used for dilution of samples and standards. In the present case, both units will be used.

Before adding the Liquid Handling Station onto the Sample Processor insert the stirrer into the socket of the LQH Station. This is done according to the description in the Liquid Handling Station manual (chapter 2). Subsequently, it is mounted onto the left side of the Sample Processor. For installation instructions, please refer to the Liquid Handling Station manual. All parts are included in the IC Equipment: Inline Dilution (6.5330.120). Please make sure that the Liquid Handling Station (LQH Station) is aligned properly before continuing the setup. All angle settings will be configured in a later step.

2.4.1.1. Rinsing unit

The waste tubing (6.1801.120) is fixed at the bottom of the rinsing station to drain the waste water.

Ultra pure water for rinsing will be supplied by the dilution Dosino. Please fill the 2 Liter bottle with ultra pure water. The water will be needed for dilution and rinsing purpose and the installation of the Dosino and its connecting parts will be mentioned in the next paragraph.

Please close the hole at bottom of the LQH Station (No.2 in the image) with a stopper.

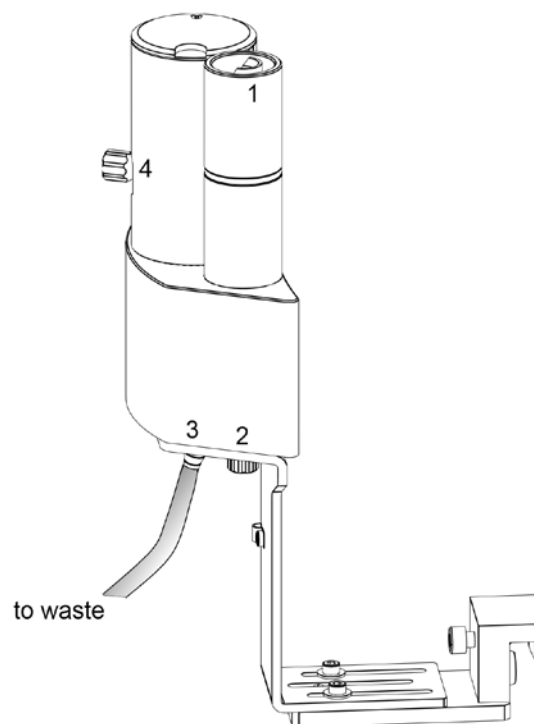

2.4.1.2. Dilution unit and 800 Dosino

At port 1 of the 10 mL Dosing Unit, please connect the loose end of the transfer tubing (6.1841.000). Port 2 is used for ultrapure water supply; therefore please screw the FEP aspiration tubing (6.1819.110) into Port 2 on the bottom of the Dosing Unit. Then fix the Dosing Unit onto the 2 liter bottle with ultra pure water. Adjust the Dosino on top and connect its cable on the backside of the 858 Sample Processor on MSB1. Please make sure that the 858 is switched off!

The stirrer cable is plugged in at the tower into the  -socket. Capillary connections are carried out according to the following scheme.

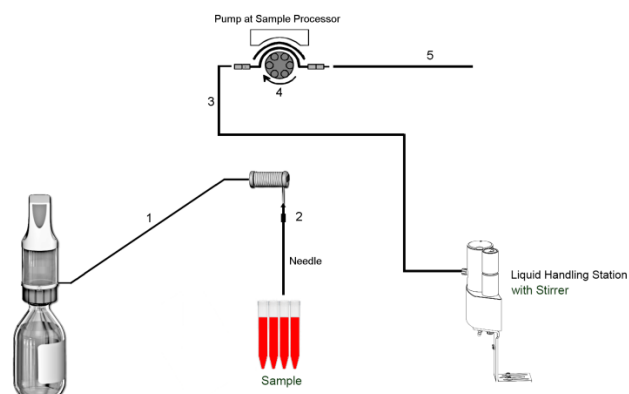

1. Transfer Tubing with holder 2 x M6 / 10 mL (6.1562.130) to be connected to Dosino port 1. The holder can be fixed as a chain element at the Tower. The other end is fixed to Adapter UNF 10/32 outer / M6 inner (6.2744.200) (see 2.)

2. Adapter UNF 10/32 outer / M6 inner (6.2744.200) for the connection between the needle and the transfer tubing
3. PTFE capillary 0.97 mm i.d. / 40 cm (6.1803.070) connected to the grey/grey pump tubing with a coupling nozzle (6.2744.034). Its other end is connected to position 1 on the side of the LQH Station with a PEEK pressure screw (6.2744.010)
4. Pump tubing LFL (gray/gray), 3 stoppers (6.1826.380)
5. The PTFE capillary 0.97 mm i.d. / 1 m (6.1803.080) is connected to the IC valve position 1. The other end is attached to the gray/gray pump tubing with the help of a nozzle coupling with security device (6.2744.160)

2.4.2. Ultrafiltration cell

In this setup, an ultrafiltration cell is mounted after the dilution of the sample (side opening of Liquid Handling Station) and before the IC system. For this, please mount the cell holder which is included in the IC Equipment: Ultrafiltration (6.5330.110) onto the Sample Processor on the right side of the tower. For detailed instructions, please refer to the Ultrafiltration Cell Manual.

The filter membrane is soaked in ultrapure water for preconditioning. After inserting the filter membrane and the sealing ring, the cell is tightly screwed together.

Capillary connections are shown in the illustration below. The flow must be higher at the sample side than at the filtrate side. That is why it is important to use a bigger pump tubing (gray/gray) and 0.97 mm i.D. capillaries on the sample side, and thinner pump tubing (yellow/orange) and the shortest possible 0.5 mm i.D. capillaries on the filtrate side. Only use the PVDF screws in combination with the UF cell as the material of the cell is prone to break with PEEK screws.

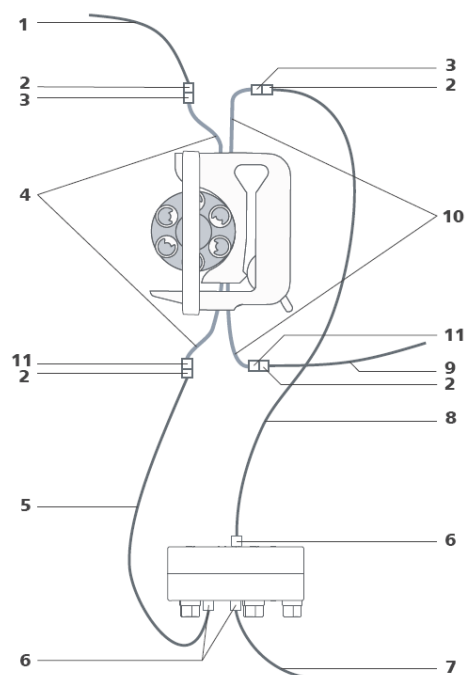

1. PTFE capillary 0.97 mm i.d. / 40 cm (6.1803.070) connected to the side of the Liquid Handling Station (Nr. 4 of chapter 2.4.1.1)
2. PEEK pressure screw (6.2744.070)
3. Coupling olive (6.2744.030)
4. Pump tubing (6.1826.380) with gray-gray stoppers for conveying the sample
5. PTFE capillary (6.1803.060) for conveying the sample from the peristaltic pump to the ultrafiltration cell (0.97 mm i.D.)
6. PVDF pressure screw (6.2744.000) for connecting the capillaries to the ultrafiltration cell
7. PTFE capillary (6.1803.080) for conveying the sample from the ultrafiltration cell to the waste collector (0.97 mm i.D.)
8. PTFE capillary (6.1803.050) for conveying the filtrate from the ultrafiltration cell to the peristaltic pump
9. PEEK capillary (6.1831.060) for conveying the filtrate from the peristaltic pump to the injection valve for anion analysis in the IC instrument
10. Pump tubing (6.1826.320) with yellow-orange stoppers for conveying the filtrate
11. Pump tubing connection with safety device (6.2744.160)

2.5. Interconnection of devices

The whole setup of the ProfIC Vario 6 Anion packet is depicted here:

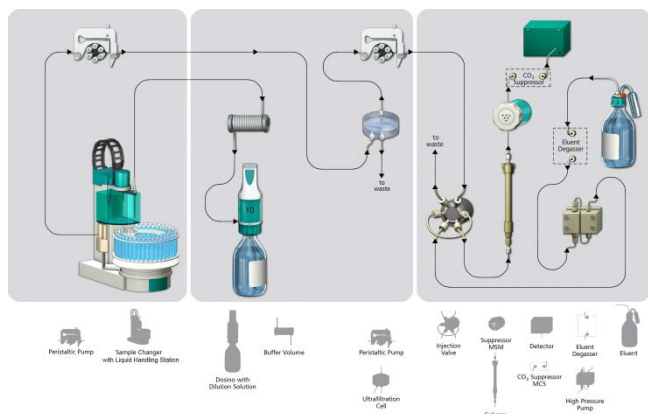

Prepare and degas an eluent suitable for the column you want to use (see column manual).

Provide the regeneration solution for the MSM Suppressor (100 mmol/L sulfuric acid for anions or 70 mmol/L Na₂CO₃, 70 mmol/L NaHCO₃ for cations).

2.6. 940 Professional IC Vario

Capillaries are connected according to the following list and the diagram below:

1. Connection to the eluent bottle
2. Capillary to Column inlet – 0.25 mm ID
3. MSM inlet capillary – labeled with *in*
4. MSM outlet capillary – labeled with *out* can be connected to the MCS or directly to the detector using a coupling (6.2744.040)
5. Detector inlet capillary
6. Detector outlet capillary connected to the MSM inlet capillary – labeled with *rinsing solution* with the help of a coupling (6.2744.040)
7. Regeneration solution aspiration capillary – PTFE, 0.5 mm ID, connected to the bottle with 100 mmol/L sulfuric acid and the orange/yellow pump tubing (8). This pump tubing is, on the other side, relied to the regeneration solution capillary of the MSM - labeled with *regenerant* - with a security lock and filter (19)
8. Peristaltic pump tubing with orange/yellow stoppers (6.1826.420)
9. MSM regeneration inlet capillary – labeled with *regenerant*
10. MSM regeneration solution outlet capillary – labeled with *waste reg.* – to be connected to the waste collector
11. MSM rinsing solution outlet capillary – labeled with *waste rins.* - to be connected to the waste collector
12. MSM rinsing solution inlet capillary - labeled with *rinsing solution*– connected to the detector outlet capillary with a coupling (6.2744.040)

13. MCS air aspiration capillary – connected to the CO₂-adsorber cartridge
14. Sample aspiration capillary – PEEK, 0.97 mm ID, coming from the Ultrafiltration Cell (chapter 2.4.2, number 9)
15. Sample outlet capillary – PTFE, 0.97 mm ID, to be placed into the waste collector
16. PEEK pressure screw short (6.2744.070)
17. Coupling 2xUNF 10/32 PEEK (6.2744.040)
18. Coupling nozzle - UNF 10/32 (6.2744.034)
19. Pump tubing connector with security lock and filter (6.2744.180)
20. PEEK pressure screw long (6.2744.090)
21. Luer coupling – connect with short PEEK pressure screw to CO₂-adsorber cartridge
22. The UNF 10/32 coupling (6.2744.040) is installed instead of the column to rinse the system with eluent. After rinsing the column is installed.

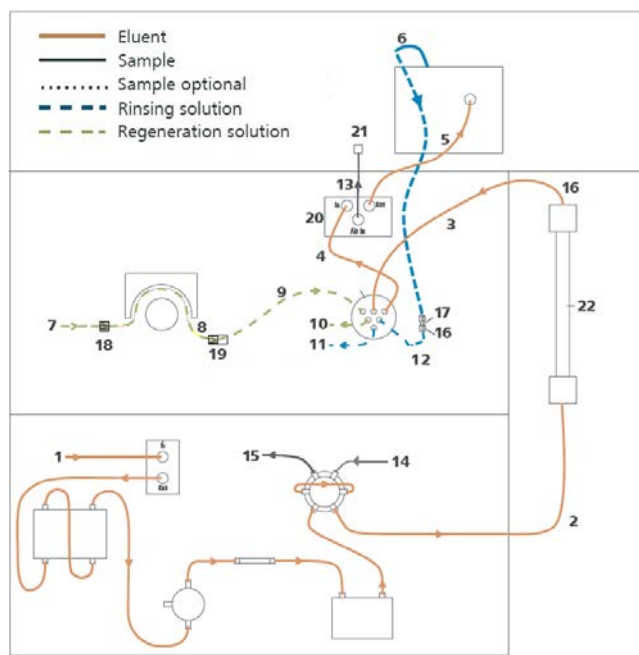

The sample injection is at position 1 of the valve. A counter current flow of the sample with regard to the eluent flow is recommended in order to minimize diffusion and carry over. Make sure that all outlet capillaries are put into the waste collector.

3. MagIC Net

3.1 Configuration

Please adjust the “view layout” of the configuration. Please configure it in the following way (the order of the sub windows is up to you):

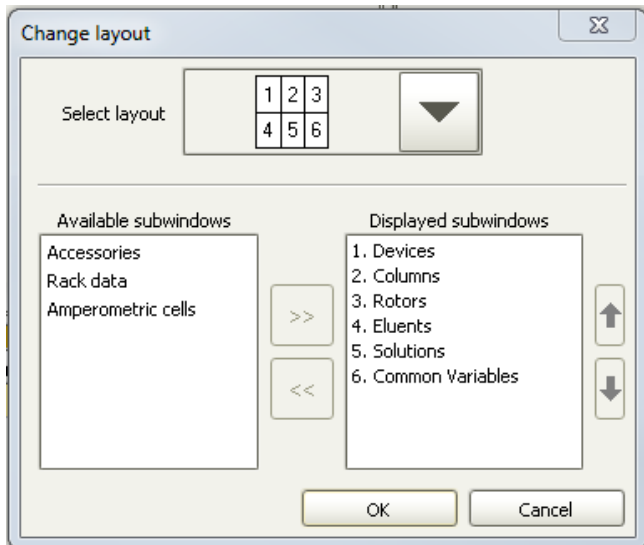

Now please connect the USB cables from the instruments and turn their power on. Connected USB devices are automatically recognized when MagIC Net is started. After confirmation of the automatically generated requests, the devices and columns are stored in the configuration. The devices are predefined as “940 Professional IC Vario 1” and “858 Professional Sample Processor 1”. Name them accordingly, if other names appear in your configuration (e.g. due to changed settings on your computer).

Accept the request to add the Dosino connected to the 940, name the Dosino solution “UPW” (for ultra pure water) and chose “Dosino” in the “Use” dropdown menu.

In the window configuration, the 940 Professional IC Vario, the 858 Professional Sample Processor and the column are visible. Add and define the eluent, the suppressor solution and the MSM Rotor.

The settings for the rack require a “work position” fitting to the respective rack (e.g. 125 mm for rack 6.2041.760).

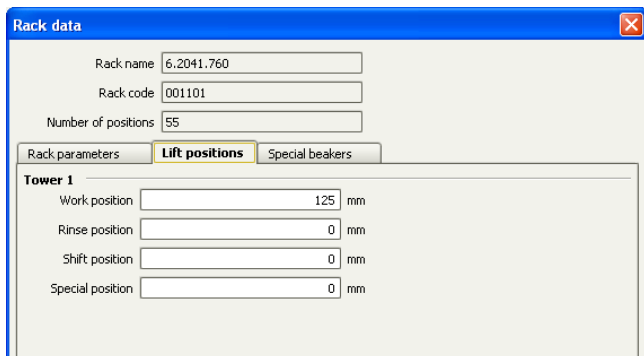

For using the Liquid Handling Station, it is necessary to define external positions for the needle. This is done in the configuration of the Sample Processor in the subtab “Tower”. Please define the external positions 1, 2 and 3 according to the picture below. Attention: The angles are only approximate values, for fine tuning, please use the manual control to find

the correct values for this system and adjust them then in the configuration.

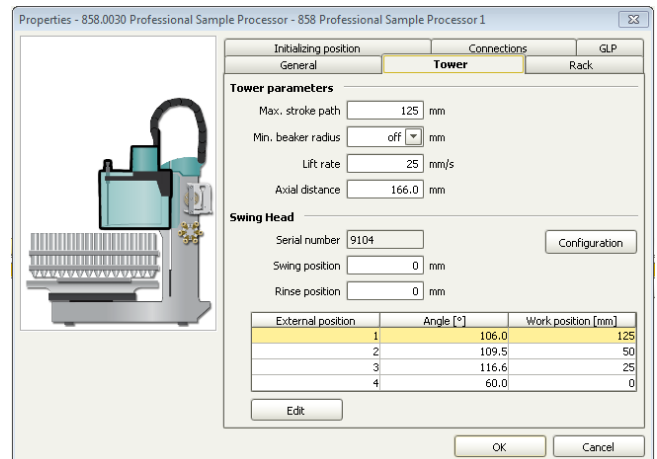

For the Dosino, the exact lengths and diameters of the tubings used need to be added for it to work properly. This can be done in the configuration as follows:

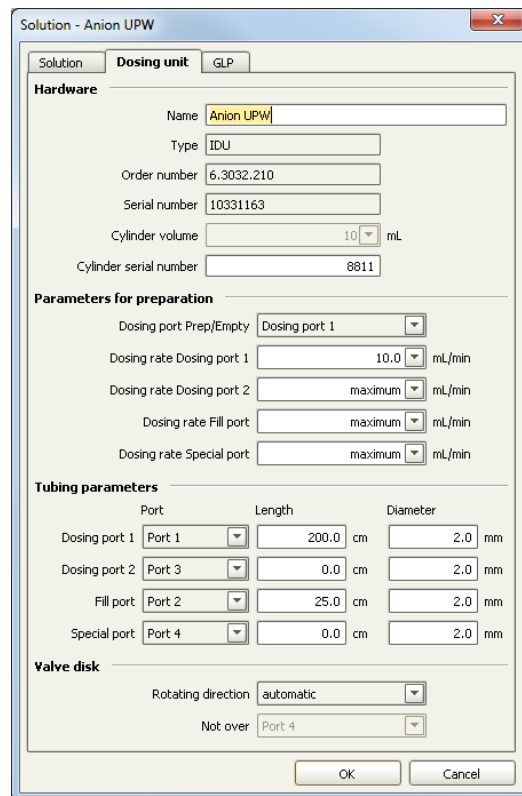

Please add a common variable called: “end volume” and set its value to 9 mL.

3.2 Method adjustment

The method for this configuration can be found in the example method folder on your MagIC Net - CD. In the window method, import the method for ProfIC Vario 6 Anion from the installation CD: Go to File → method manager and choose your method group. Afterwards, click on edit → import

and choose the pathway on the installation CD: MagICNet\examples\methods\ ProfIC Vario \ProfIC Vario_6_Anion.imet

In the window method, open the ProfIC Vario 6 Anion method and assign the following equipment: Assign the suppressor solution to the IC peristaltic pump and set the speed rate to 1, add your Rotor to the MSM and activate the automatic stepping all 10 minutes, define the rack of the connected sample processor, assign the eluent to the IC pump and assign the column to the analysis. Adjust the temperature of the column oven to 45°C. Check the analytes in the components table and adapt if necessary.

Perform a method test and save the method.

3.3. Purge of the system

Before inserting the column, disconnect the Out capillary of the suppressor connection piece from the MCS or from the detector and put it into a waste beaker. The suppressor needs to be rinsed with the system first and its waste should not pass through the sensitive MCS and/or detector in the beginning, as loose particles could be flushed out.

Now, please flush the system for about 10 minutes and get rid of air bubbles (by using the purge valve and syringe). During these 10 minutes, step the MSM three times in order to flush all three chambers.

As soon as the whole system is purged, reconnect the suppressor Out capillary back to the MCS or the detector.

Now insert and rinse the precolumn for 10 minutes by leading the outlet directly into the waste. Afterwards connect the analytical column and flush it likewise for 10 minutes. Only afterward the column is completely connected to the flow path of the eluent (see also 940 manual). Start the peristaltic pump and adjust the pressure of the lever on the tubing, in order to see the droplets of suppressor regeneration solution drop into the waste collector. Rinse the Dosino and fill the transfer tubing by applying the “prepare” button under manual control.

In order to start the equilibration, go to the window work place, load the anion method, and press “Start HW”.

Equilibrate the system until the baseline is stable.

3.4. User defined determination

In the window method, under evaluation, enter the ions and the concentrations of the required standards. You can either calibrate with a set of calibration standards, or you can calibrate with only one standard and diluting this one to different calibration levels.

If you wish to calibrate by diluting one standard solution, the standard with the highest concentration has to be prepared and labeled as standard 1 in this method. All other standards have to be divisors of standard 1, e.g. all components of

standard 2 have half the concentration of those in standard 1, all components of standard 10 have a tenth of the standard 1 concentration.

Always use the standard number as the factor that lies between the two solutions. Make sure to always fix the dilution factor = 1 for all the standards in your determination table.

Now please add the correct Database in the Evaluation window (Evaluation - Results - Database) for the method.

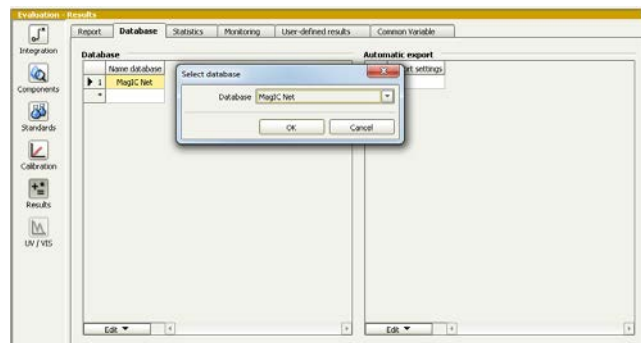

In the window work place, set up a “determination series”, describing your samples by ident, vial number, sample type (standard, blank, or sample etc.). After putting the analyte solutions onto the rack, press “start”.

In the field dilution, indicate the dilution you wish to apply to your sample, e.g. “2” if you want to dilute your sample 2 times. If no dilution is required or a standard is measured, write 1. After putting the analyte solutions onto the rack, press “start”.

For evaluation and after recording the first chromatogram, check the retention times of your compounds. Since they depend on the performance of your column, you may have to adjust them in your method.

4. Exemplary measurement

This data was recorded using a MSM Rotor A with the Adapter Vario on a Metrosep A Supp 15 - 150/4.0 column.

Fluoride, chloride, nitrite, bromide nitrate, sulfate, and phosphate were measured as exemplary standard anions (5 ppm). With Metrosep A Supp 15 - 150/4.0, sulfate elutes faster than phosphate.

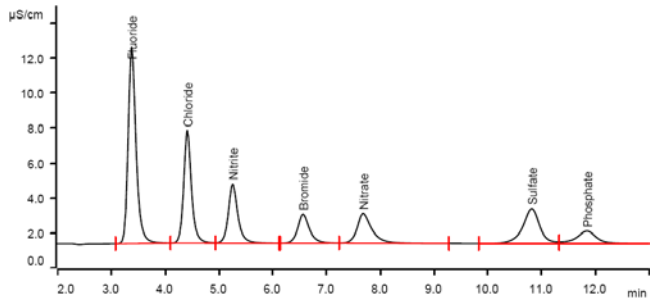

For the calibration, the average peak areas of 3 injections were evaluated. Within the concentration range of 1 – 20 ppm, a quadratic curve type was used for evaluation. Correlation coefficients and standard deviations are listed in the following table. The calibration curve for fluoride is shown as an example.

	Correlation coefficient	Percentage standard deviation [%]
Fluoride	0.999993	0.414
Chloride	0.999979	0.739
Nitrite	0.999938	1.279
Bromide	0.999936	1.316
Nitrate	0.999942	1.254
Sulfate	0.999967	0.946
Phosphate	0.999974	0.845

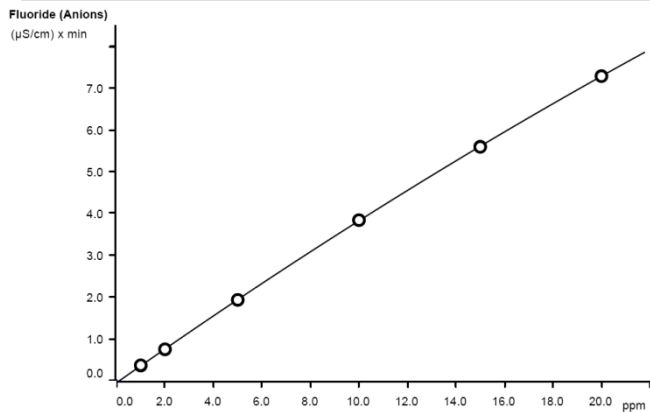

Function:	$A = -0.0583533 + 0.0204404 \times Q - 5.23881E-6 \times Q^2$	
Relative standard deviation	0.414%	
Correlation coefficient	0.999993	
Curve type	Quadratic	
Weighting	1	

The precision of 10 injections of a 2 ppm solution of standard anions was determined. The results are shown in the following table and an exemplary trend chart is shown for phosphate.

Ion	Standard deviation	
	relative [%]	absolute [ppm]
Fluoride	0.005	0.264
Chloride	0.013	0.652
Nitrite	0.014	0.709
Bromide	0.008	0.387
Nitrate	0.012	0.569
Sulfate	0.001	0.052
Phosphate	0.004	0.168

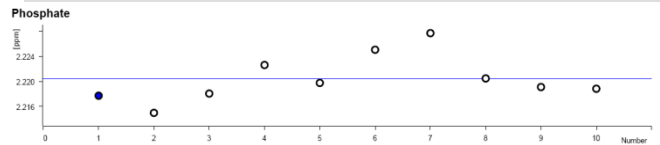

5. Optional equipment

5.1. Eluent Production Module

The 941 Eluent Production Module creates fresh new eluent out of eluent concentrate and ultrapure water. For installation instructions and further information, please refer to the 941 Eluent Production Module Manual.

5.2. Alternative MSM rinsing and regeneration methods

For alternative suppressor rinsing and regeneration methods and setups, please refer to the AB-395.