

Capillary Ion Chromatography Mass Spectrometry for Trace Environmental Analysis

Leo Jinyuan Wang,¹ Jonathan Beck,² and William C. Schnute¹

¹Thermo Fisher Scientific, Sunnyvale, CA, USA; ²Thermo Fisher Scientific, San Jose, CA, USA

Executive Summary

Capillary IC-MS offers unique chromatographic selectivity for polar analytes and can be used as a complementary technique to reversed phase LC-MS in trace level analysis. Compared to conventional IC, capillary IC offers higher mass sensitivity, reduces eluent consumption, decreases waste, and allows continuous system operation, ultimately leading to reductions in total cost of ownership. Coupling capillary IC to MS detection requires modification and optimization of existing electrospray ionization (ESI) interfaces. Optimized configurations enable highly sensitive and selective determination of ppt to low ppb levels of analytes in environmental samples.

Key Words

Capillary IC, IC-MS, Environmental analysis, ICS-5000 RFIC

Introduction

IC has been used extensively as a complementary separation technique to high performance liquid chromatography (HPLC). Recent applications include coupling to MS for identity confirmation, structural interpretation, and trace level analysis in complex matrices. The introduction of innovative capillary IC further improves the usability of IC-MS for trace-level analysis and sample-size-limited research such as in metabolism/metabolomics. The main challenges of interfacing capillary IC and MS are compatibilities in mobile phase composition and flow rate. This study demonstrates the instrumentation and application solutions for capillary IC-MS utilizing a Thermo Scientific™ Dionex™ ICS-5000 Reagent-Free™ IC (RFIC™) system with suppression technology which converts the MS-incompatible mobile phase to deionized (DI) water, and a modified ESI source which optimizes capillary flow sensitivity.

Using capillary IC with an RFIC system in conjunction with the optimized ESI source, this study demonstrates successful applications for trace level environmental analysis, including common anions and organic acids, perchlorate, and residue of the herbicide endothall in environmental water samples.

Instrumentation

A Dionex ICS-5000 RFIC system was used in this study, consisting of a SP Single Pump, an eluent generator (EG) module with a Thermo Scientific Dionex EGC-KOH (Capillary) Cartridge, and a DC Detector/Chromatography Compartment featuring a Thermo Scientific™ Dionex™ IC Cube™ with suppressed conductivity detection. The suppressor was operated in external-water mode with DI water regenerant delivered by a Thermo Scientific Dionex AXP-MS Auxiliary Pump at a flow rate of 50 $\mu\text{L}/\text{min}$.

As seen in Figure 1, the eluent of the RFIC system conductivity detector was connected to a divert valve which directs the flow to waste or the MS detector flow path. Organic desolvation solvent was delivered by another Dionex AXP-MS Auxiliary Pump, combined with the chromatographic eluent via a micromixing tee, and passed through a grounding union before entering the MS detector via the optimized capillary ESI interface.

The detailed chromatographic and MS detection conditions are listed with each chromatogram.

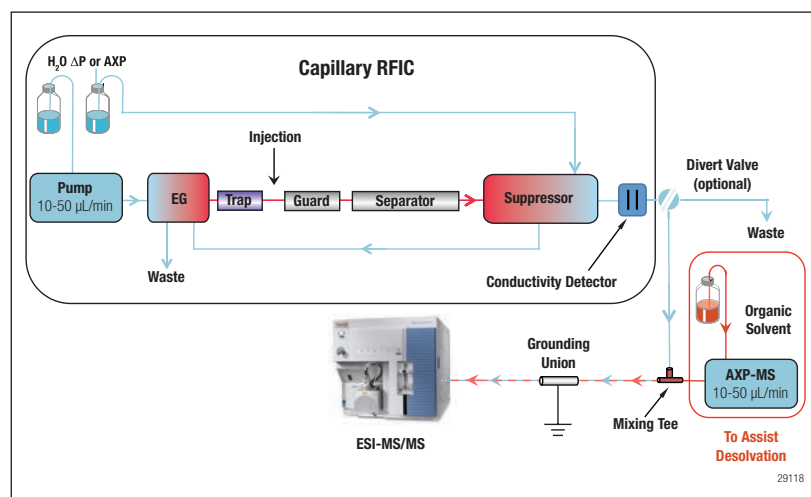

Figure 1. Preferred capillary IC-MS system schematics.

Capillary IC-MS Interface Optimization

The optimization of the capillary IC-MS interface was deemed to be a necessity and of paramount importance for system detection sensitivity. Commercially available interfaces can be divided into two categories based on compatible flow rate ranges: nano-ESI sources usually cover flow rates below 1 $\mu\text{L}/\text{min}$; analytical ESI interfaces are designed for a broad flow rate range of 1 to 2000 $\mu\text{L}/\text{min}$, generally with higher performance in the range of 50 to 1000 $\mu\text{L}/\text{min}$.

A Thermo Scientific Ion Max source was selected for this study as shown in Figure 2. The parameters related to sensitivity include: the diameter of the ESI spray capillary; the proximity of the spray capillary tip to the MS entrance (controlled by probe depth and probe x-y-z adjustments); the ESI voltage; vaporizer and transfer capillary temperatures; and gas flows including sheath, auxiliary, and ion sweep gases.

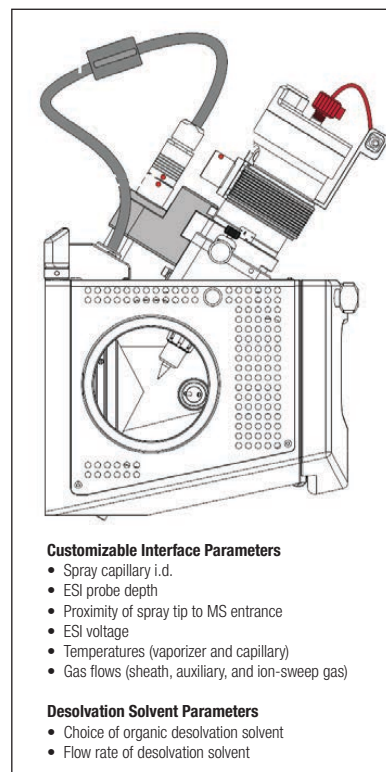

Figure 2. The Ion Max source interface and optimization parameters.

Figure 3 demonstrates the significant effect on MS sensitivity from the spray capillary internal diameter. The top chromatograms were obtained using a 32 gauge (0.235 mm) capillary, and the bottom chromatograms were obtained on a 34 gauge capillary (0.184 mm). With the same injection volume, significantly higher sensitivity can be achieved via the smaller internal diameter ESI capillary.

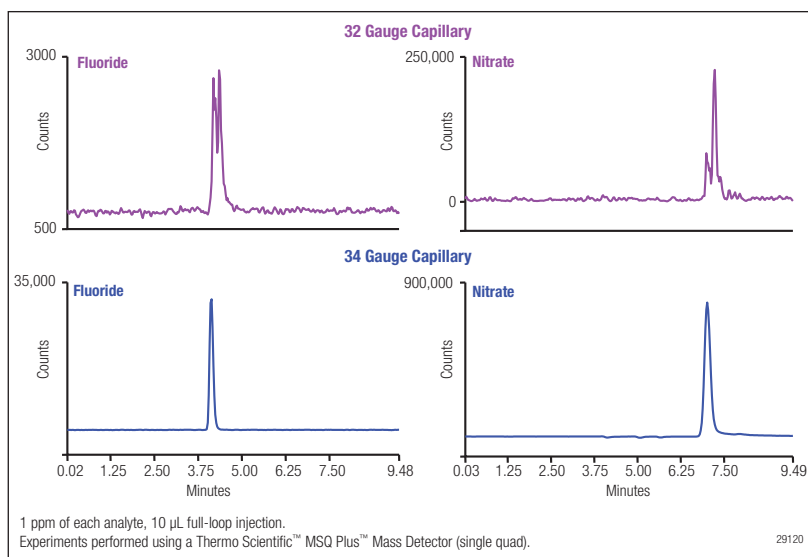

Figure 3. Spray capillary i.d. affects sensitivity.

The desolvation solvent parameters also need to be optimized for each application. The choice of organic solvent and the flow rate of its introduction were observed to be of particular importance in improving MS detection sensitivity. As seen in Figure 4, more than a 10-fold increase in MS response was achieved at the experimentally determined optimal flow rate of desolvation solvent (acetonitrile in this experiment).

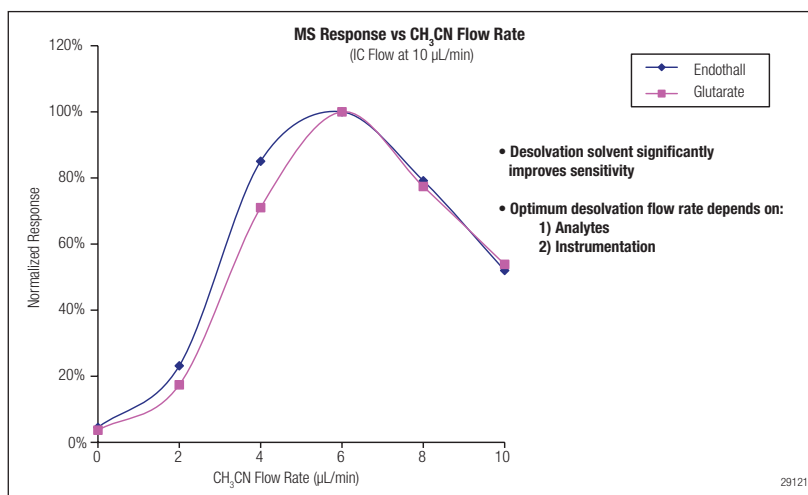

Figure 4. Desolvation solvent improves sensitivity.

Applications

Common Anions and Organic Acids

The first application using capillary IC-MS demonstrates the confirmation and sensitive quantitation of five commonly seen anions: fluoride, chloride, nitrate, sulfate, and phosphate, and one selected organic acid: tartaric acid. As shown in Figure 5, these analytes can be detected with excellent sensitivity and selectivity. This application takes advantage of the capillary format of the ion exchange column which improves the detection limits with the same injection volume, as well as the enhanced low mass detection capability of the MSQ Plus single quadrupole mass spectrometer for the detection and quantitation of low molecular weight analytes with significantly improved sensitivity.

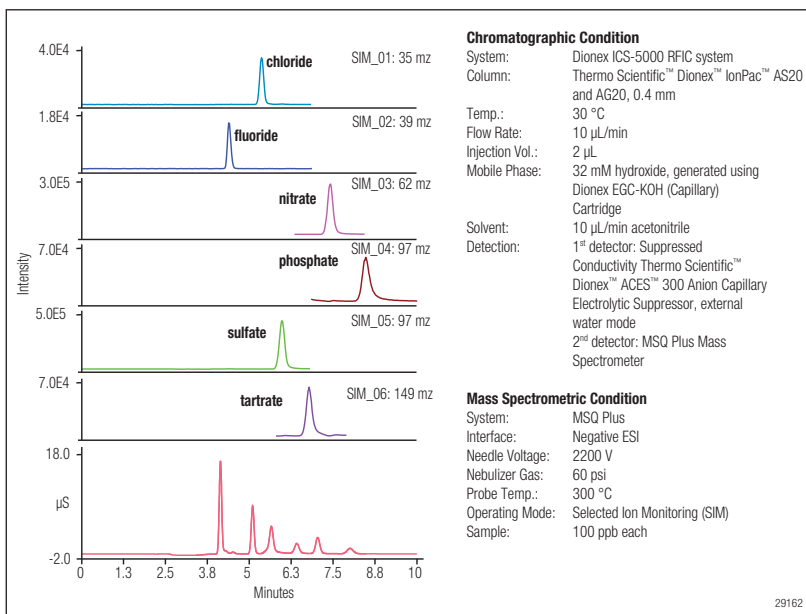

Figure 5. Sensitive and selective determination of common anions and organic acids using capillary IC-MS.

Ultratrace-Level Perchlorate in Environmental Water

Perchlorate has been found in various media and is now considered a widespread contaminant in the United States. Perchlorate poses an adverse effect on human health by competitively inhibiting iodide uptake and reducing thyroid hormone production, which is essential for proper protein expression, neuronal differentiation, and other functions.

Figure 6 shows the ultrasensitive quantitation of perchlorate at a 10 parts-per-trillion (ppt, ng/L) level using an online solid-phase extraction (SPE) capillary IC-MS configuration. Using this setup, a 1 mL sample is injected directly onto the online Thermo Scientific™ Dionex™ IonSwift™ MAC-200 Monolith Anion Concentrator Column, and using an MSQ Plus single quadrupole mass spectrometer, is detected using selected ion monitoring (SIM) mode.

Endothall

Endothall is an herbicide widely used for both terrestrial and aquatic weeds, including defoliation of cotton, the control of aquatic weeds and algae, and as a desiccating agent for potatoes. Human exposure to endothall in excess of the maximum contamination level (MCL) may cause gastrointestinal problems, and therefore is regulated in drinking water by the United States Environmental Protection Agency (EPA) with an MCL of 100 µg/L and by the California EPA with a public health goal (PHG) of 580 µg/L.

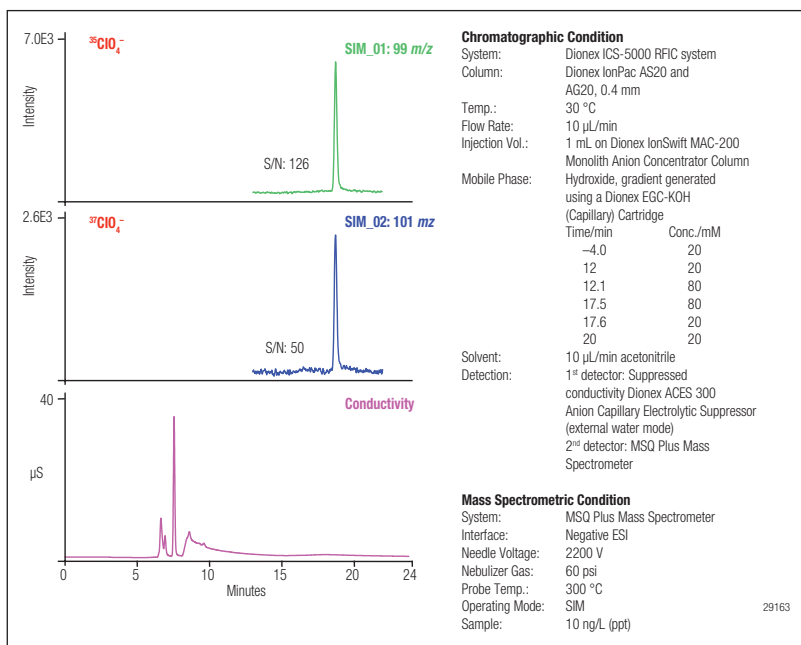

Figure 6. Ultratrace-level perchlorate determination using online SPE and capillary IC-MS.

Figure 7 shows the direct analysis of trace-level endothall in water samples. Endothall was separated from seven common anions on a capillary Dionex IonPac AS19 column within 10 min using an electrolytically generated hydroxide gradient at 10 µL/min. The Thermo Scientific™ TSQ Quantum Access™ MS/MS instrument was operated in selected reaction monitoring (SRM) mode, requiring minimal sample cleanup and ensuring highly sensitive (low ppb) and selective quantitation. Isotope labeled glutaric acid (glutaric acid- d_6) was used as an internal standard to ensure quantitative accuracy. This application combines the increased mass response of capillary IC with the selectivity and sensitivity of MS/MS to identify the regulated compound endothall.

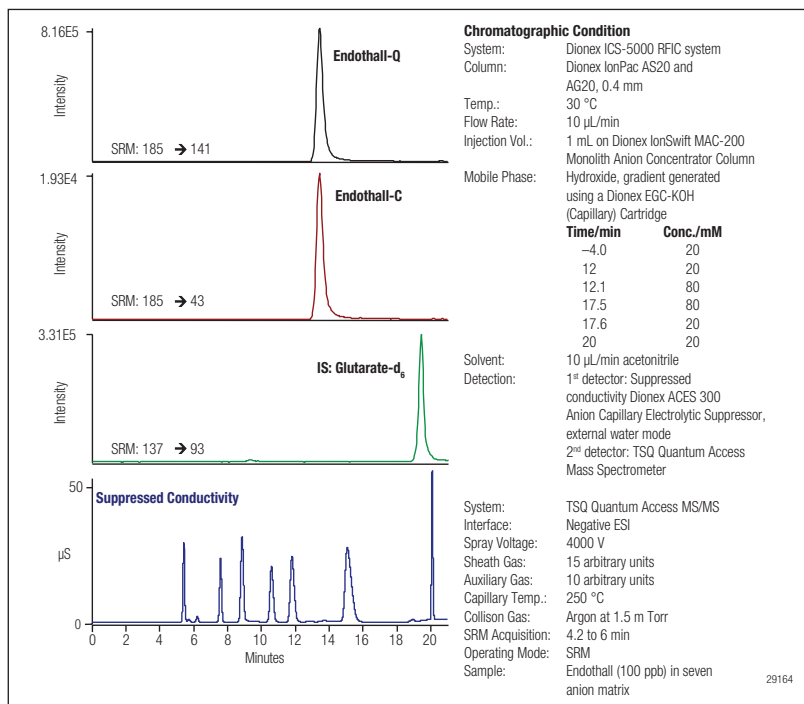

Figure 7. Quantitation of the herbicide endothall in environmental water samples.

Conclusion

This study describes the instrumentation of capillary ion chromatography with mass spectrometry, and the importance of optimizing the interface parameters to achieve the best system performance. Analytical solutions developed using these optimized configurations demonstrate successful application to trace level environmental analysis, including common anions and organic acid, perchlorate, and herbicide endothall residue in environmental water samples.

www.thermoscientific.com/dionex

©2012 Thermo Fisher Scientific Inc. All rights reserved. ISO is a trademark of the International Standards Organization. All other trademarks are the property of Thermo Fisher Scientific Inc. and its subsidiaries. Specifications, terms and pricing are subject to change. Not all products are available in all countries. Please consult your local sales representative for details.

Australia +61 3 9757 4486
Austria +43 1 616 51 25
Benelux +31 20 683 9768
 +32 3 353 42 94
Brazil +55 11 3731 5140

China +852 2428 3282
Denmark +45 36 36 90 90
France +33 1 39 30 01 10
Germany +49 6126 991 0
India +91 22 2764 2735

Ireland +353 1 644 0064
Italy +39 02 51 62 1267
Japan +81 6 6885 1213
Korea +82 2 3420 8600
Singapore +65 6289 1190
Sweden +46 8 473 3380



Thermo Scientific Dionex products are designed, developed, and manufactured under an ISO 9001 Quality System.

Switzerland +41 62 205 9966
Taiwan +886 2 8751 6655
UK +44 1276 691722
USA and Canada +847 295 7500

Thermo
 S C I E N T I F I C

Part of Thermo Fisher Scientific