



A fresh look  
at food  
and beverage  
analysis

# Discover the potential of ion chromatography for the modern analytical laboratory

1

Preface

2

Why choosing ion chromatography (IC) for food and beverage analysis?

3

Applications – selected examples from the food and beverage sector

4

IC compliance with norms and standards

5

Time and money savers – automation and Metrohm Inline Sample Preparation (MISP)

6

Learn more about IC – IC in brief

# Preface



Over the last years, awareness of food quality and ingredients has seen a massive increase. Consumers want to know what they eat and expect thorough and detailed food labelling. Public authorities have responded to this with more stringent quality standards and labelling requirements (e.g., EU regulation 1169/2011 or the US regulation 21CFR101). In order to meet them, fast, robust, and reliable food analysis is a must.

How do you analyze carbohydrates, additives and ionic substances in foods and beverages? How do you check the quality of raw materials for adulterants and contaminants? Do you use single-analyte methods such as titration and/or sophisticated enzymatic or LC-MS/MS methods? Does your laboratory staff struggle with time-consuming and error-prone manual sample preparation steps such as Carrez precipitation and manual dilution?

Food and beverage analysis is challenging – not just because of the large number of analytes that must be monitored in compliance with the national and international norms and standards but also due to the complex matrix of many foodstuffs themselves.

**Ion chromatography can address many of these challenges better than other, more traditional and therefore more familiar methods.** IC is an easy-to-use, highly robust analytical technique with the possibility to quantify multiple components in a single run. Moreover, automated inline sample preparation procedures such as dialysis, filtration, and dilution help you save time and reduce error prone and time-consuming manual steps to a minimum. Of course, you can expect the latest convenience and security features from modern IC software: automated data evaluation, monitoring of quality criteria and the output, as well as full traceability of results.

Enjoy reading this e-book and let us show you how you can bring your food and beverage analysis to the next level – enhancing productivity, reducing costs, and benefitting from accurate, reliable, and robust results.



# Why choosing ion chromatography (IC) for food and beverage analysis?

*IC is a robust and time-saving technique for multicomponent analysis in foods and beverages. It is superior to single-component analytical techniques and less complex than hyphenated techniques, but highly specific, precise, robust, and easy to use.*

This technique is straightforward and easy to use with low instrument and operating costs.

Hyphenated analytical techniques like GC-MS or LC-MS/MS are powerful but complex to use. They suffer from high operating costs and require well-trained personnel.

IC is a multicomponent technique—environmentally friendly due to its low chemical usage. Inline sample preparation reduces lab work, minimizes consumable costs and enhances data accuracy.

Single-component techniques (e.g., discrete analyzers, enzymatic assays) are limited in scope and require costly reagents. Accuracy and susceptibility to interferences depend on the food matrix, and filtration is necessary.

Flexibility is synonymous with IC. Several detectors are available and can be combined for comprehensive analysis of anions, cations, carbohydrates, as well as for automated determinations of pH value, conductivity, and titration parameters when combining IC and titration (TitrIC).

Other analytical methods are dedicated for single-detector usage, limiting the kind of data that can be collected.

When utilizing amperometric detection, IC is selective, sensitive, and quick, with  $\mu\text{g/L}$  detection limits.

Working ranges for methods like refractive index (RI) detection or titration (e.g., Optimized Monier-Williams, AOAC Method 990.28) are within % to mg/L range. Depending on the matrix, interferences could limit precise quantification.



Metrohm Inline Sample Preparation (MISP) for IC saves labs time and money by eliminating manual work (e.g., Inline Dialysis instead of Carrez precipitation). Sample preparation cartridges are rarely required.

Classical sample preparation often involves extensive reagent preparation and labor-intensive extraction steps. Reproducibility can suffer.

## Applications – selected examples from the food and beverage sector



### BEVERAGE

- Carbohydrates in juice, coffee, beer
- Sweeteners and sugar substitutes
- Cations and anions in beer and water
- Herbicides in water
- Organic acids and anions in wine
- Biogenic amines and cations in wine

### ADDITIVES, PRESERVATIVES, NUTRIENTS

- Nitrate and nitrite in foodstuffs
- Polyphosphates in seafood
- Sulfite in mustard and dry fruits
- Bromate and iodate in flour
- Iodate and iodide in salt
- Galacto-oligosaccharides (GOS) in supplements



### DAIRY

- Lactose in low-lactose products
- Carbohydrates in milk products
- Iodide in milk
- Nitrate and nitrite in milk
- Choline in milk powder formula
- Fructans in infant formula



# Beverage

## Coffee quality assurance – Free and total carbohydrate analysis

### SUMMARY

One of the most popular beverages and of huge economic importance is coffee. Quality assurance and tracing of adulterants is therefore a widely established process. Carbohydrates (CHOs) in particular, which can make up to 50% of raw coffee beans, contribute to flavor, viscosity, and aroma. Furthermore, they serve as authenticity tracers. ISO 11292 and AOAC 996.04 define quality standards for instant coffee - the analysis of free and total carbohydrates. Free carbohydrates in coffee are determined after simple dilution, while total carbohydrates are determined as sum parameter after acidic hydrolysis.

The present method describes the precise separation and quantification of all relevant analytes according to AOAC and ISO on a Metrosep Carb 2 column followed by post-column addition (PCR) and pulsed amperometric detection (PAD).

### SAMPLES AND SAMPLE PREPARATION

- Instant coffee ( $\approx 300$  mg)
- Free CHOs: Dissolution in 100 mg ultrapure water (UPW) and filtration (0.25  $\mu\text{m}$ )
- Total CHOs: Hydrolyzation in HCl (0.1 mol/L) at 100 °C (150 min), dilution to 100 mL UPW and filtration with an  $\text{Ag}^+\text{-H}^+$ -cartridge combination, final dilution (10–50-fold) with UPW

### EXPERIMENTAL

10 CHOs (mannitol, arabinose, galactose, glucose, mannose, fructose, and sucrose for dissolved CHOs plus xylose for total CHOs in addition to rhamnose and ribose) were baseline separated on a Metrosep Carb 2 column with a binary high-pressure gradient combined with a flow gradient (940 Professional IC Vario ONE/HPG

configuration). The amperometric detection was performed after post-column addition with 300 mmol/L NaOH.

### RESULTS

For the different instant coffee samples, the free CHO content ranged from 10 to 100 g/kg with arabinose, galactose/glucose, and fructose as the major components. The total CHO content after HCl hydrolysis was between 300–400 g/kg with galactose and mannose as main constituents.

### BENEFITS

- Separation of multiple CHOs by a concentration- and flow-gradient combination within a single run
- Selective and sensitive detection with PAD
- Conforms with ISO 11292, AOAC 996.04, DIN 10780:2003

#### Metrosep Carb 2 - 250/4.0

Eluent	A: UPW B: 0.2 mol/L NaOH + 1 mmol/L NaOAc
Flow	Flow gradient (0.5 – 0.8 mL/min)
Temp	27 °C
Injection	20 $\mu\text{L}$
Detection	PAD, 0.05 V

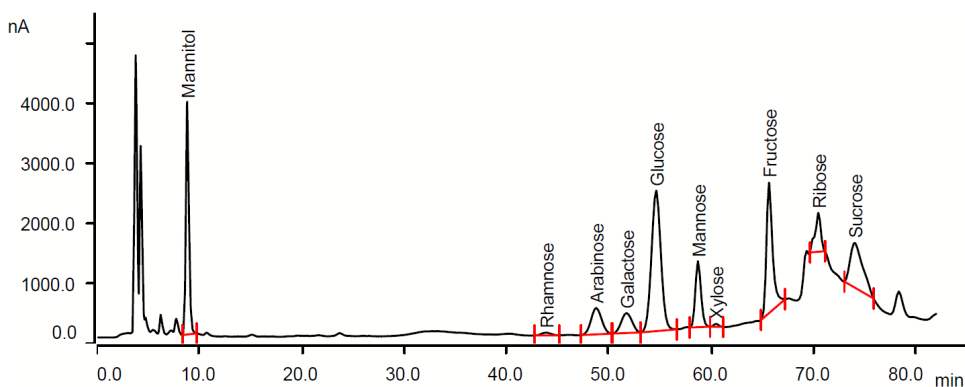

Free sugars in instant coffee with mannitol (24 mg/L), rhamnose (1.3 mg/L), arabinose (11 mg/L), galactose (10 mg/L), glucose (51 mg/L), mannose (14 mg/L), xylose (0.6 mg/L), fructose (82 mg/L), ribose (5.6 mg/L), sucrose (29 mg/L).



# Beverage

## Carbohydrates in orange juice

### SUMMARY

EU Regulation No. 2012/12/EU sets standards for production, composition and labelling of fruit juices. These regulations are intended to comply with the newest technical improvements described in the Codex-Norm. The CODEX STAN 247-2005 regulates quality and labelling of fruit juices and is a widely accepted role model for standards at national levels [1].

One requirement for accurate labelling is the indication of the sugar content and addition of sugars.

This robust and straightforward IC method with amperometric detection is suitable to analyze various carbohydrates directly in the juice matrix. Automated inline sample preparation with Inline Ultrafiltration or Inline Dialysis replaces manual steps making sample preparation much more efficient.

### SAMPLES AND SAMPLE PREPARATION

- Orange juice (Granini™) diluted in ultrapure water (500- or 1000-fold)

### MISP

- Inline Dilution (optional)
- Inline Ultrafiltration

### EXPERIMENTAL

Samples were injected after manual dilution and Inline Ultrafiltration. The major carbohydrates, inositol, glucose, fructose, and sucrose, were separated isocratically on a Metrosep Carb 2 column. Pulsed amperometric detection enabled a very sensitive detection and prolongs the lifetime of electrodes.

This analysis is performed on a small footprint IC and cost of ownership is low. To check system stability a check standard was measured every sixth sample.

### RESULTS

In the orange juice samples the monosaccharides glucose and fructose ( $\approx 2$  g/100 mL) and the disaccharide sucrose ( $\approx 4$  g/100 mL) are dominant. The sum of 8.8 g/100 mL carbohydrates corresponded to the product label (9 g/100 mL). Inositol was found in low concentrations ( $\approx 0.2$  g/100 mL). The system showed excellent stability over 48 h with RSDs for the analyzed check standards of  $<1.5\%$ . No electrode cleaning was necessary within that timeframe.

### BENEFITS

- Inline Ultrafiltration protects the column and system
- Manual sample preparation is not required
- Sensitive quantification of multiple carbohydrates in a single run

#### Metrosep Carb 2 - 150/4.0

Eluent	100 mmol/L NaOH + 10 mmol/L NaOAc
Flow	0.5 mL/min
Temp	30 °C
Injection	20 $\mu$ L
Detection	PAD, 0.05 V

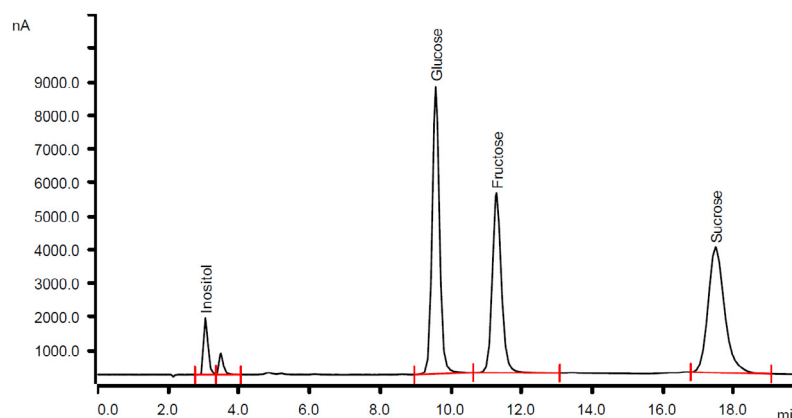

Pulsed amperometric signal of an orange juice sample (1000-fold dilution) containing inositol (0.2 g/100 mL), glucose (2.1 g/100 mL), fructose (2.3 g/100 mL), and sucrose (4.3 g/100 mL) as major carbohydrates.



# Beverage

## Tracing juice adulterants - cellobiose in apple juice

### SUMMARY

Cellobiose, a disaccharide with two glucose molecules connected by a  $\beta$ -1,4-glycosidic bond, has gained importance as a novel food ingredient serving as low-calorie bulking agent or lactose substitute. However, it is also considered as a contaminant and adulterant from cellulose degradation and can be an indicator for authenticity infringements. The International Fruit and Vegetable Juice Association (IFU) only recommends cellobiose analysis with capillary gas chromatography [1]. IC is an easy-to-use and cost-efficient alternative.

Analysis of cellobiose in apple juice is possible with manual or automated dilution and filtration within less than 30 minutes using IC with pulsed amperometric detection (IC-PAD). The flow gradient elution from the robust Metrosep Carb 2 column reduces overall determination time.

### SAMPLES AND SAMPLE PREPARATION

- Apple juice, diluted 10-fold

### MISP

- Inline Ultrafiltration

### EXPERIMENTAL

Separation of cellobiose from other carbohydrates and sugar alcohols was accomplished on a Metrosep Carb 2 column. Signal detection was performed by PAD using a Wall-Jet cell (Au working and Pd reference electrode). Analysis time and column cleanup was accelerated with a flow gradient:

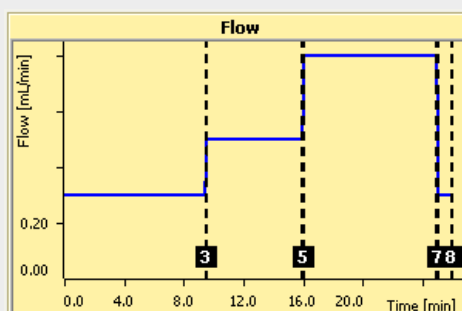

### RESULTS

Cellobiose eluted after 22 minutes. The analyzed sample contained about 5 mg/L cellobiose. Spiking tests with 5 and 10 mg/L cellobiose showed excellent recoveries of 102% within the range of usual acceptance criteria.

Beside cellobiose, other sugar alcohols and carbohydrates (e.g., inositol, xylitol, arabinol, sorbitol, mannitol, rhamnose, glucose, xylose, fructose, sucrose) can be determined with this method. This shows the flexibility of IC: without any further technical upgrades the complexity of the analyses can be increased towards a multiple-analyte method.

### BENEFITS

- Fast cellobiose elution
- Multi-analyte determination possible

Metrosep Carb 2 - 150/4.0	
Eluent	100 mmol/L NaOH + 10 mmol/L NaOAc
Flow	Flow gradient (0.3 – 0.8 mL/min)
Temp	30 °C
Injection	20 $\mu$ L
Detection	PAD, 0.05 V

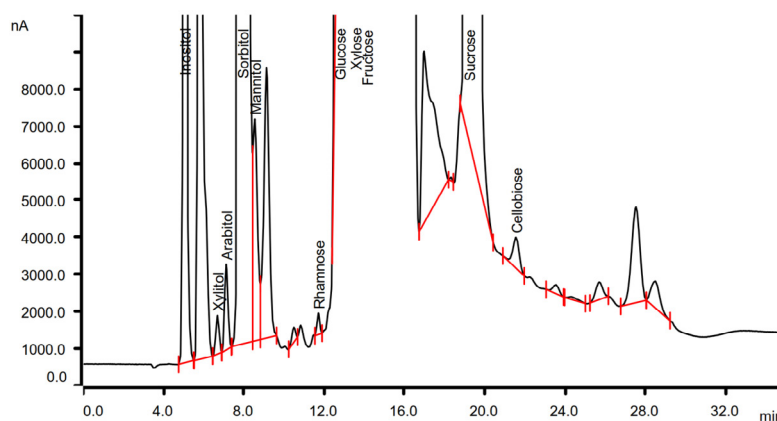

Amperometric signal of the analysis of apple juice spiked with 5 mg/L cellobiose (recovery 102%). A step-flow gradient improved the separation and shortened column clean-up time. Inline Ultrafiltration was used for automatic sample preparation, additionally set-up efficiency benefits from inline dilution replacing manual steps.





# Beverage Analysis of raffinose, stachyose, and verbascose

## SUMMARY

The raffinose family of oligosaccharides are  $\alpha$ -galactosyl derivatives of sucrose. The most common derivatives are the trisaccharide raffinose, the tetrasaccharide stachyose, and the pentasaccharide verbascose [2].

Such raffinose derivatives occur naturally in vegetables (e.g., green beans, soybeans, and other beans) and in other plants. Stachyose is less sweet than sucrose, at about 28% by weight. It is mainly used as a bulk sweetener or for its functional oligosaccharidic properties.

These oligosaccharides are readily separated from polyols, and mono- and disaccharides on the Metrosep Carb 2 column. A flow gradient enables optimal separation with minimal technical requirements of only one high-pressure pump. Detection with pulsed amperometry (PAD) is the method of choice for selective and sensitive determination.

## MISP

- Partial loop injection (MiPT)

## EXPERIMENTAL

Standards were analyzed on a 940 Professional IC Vario ONE equipped with pulsed amperometric detection (PAD). The cooled autosampler contained an injection valve with partial loop mode for variable injection volumes (2–50  $\mu$ L with 1  $\mu$ L increments). Carbohydrates were separated on a Metrosep Carb 2 column applying a flow gradient for optimal separation within 45 minutes.

## RESULTS

Eight carbohydrates were analyzed in the  $\mu$ mol/L range. Raffinose was separated from stachyose, eluting after 36 min. Calibration was linear over a concentration range of 1:100, e.g., stachyose 0.4–40  $\mu$ mol/L (table below). PAD enabled

sensitive detection of all carbohydrates.

Name	RSD [%]	R <sup>2</sup>
Sorbitol	0.785	0.999980
Mannitol	1.099	0.999960
Glucose	0.246	0.999998
Galactose	0.371	0.999995
Fructose	0.832	0.999977
Sucrose	0.493	0.999992
Stachyose	0.442	0.999994
Verbascope	2.050	0.999861

## BENEFITS

- Quantification of raffinose, stachyose, and verbascose next to common sugars and sugar alcohols in a single run
- Flow gradient with just one high-pressure pump for optimal separation
- Baseline resolution of glucose and galactose
- Stable samples thanks to 889 IC Sample Center – cooltable

### Metrosep Carb 2 - 250/4.0

Eluent	200 mmol/L NaOH + 1 mmol/L NaOAc
Flow	Flow gradient (0.4 – 0.7 mL/min)
Temp	30 °C
Injection	20 $\mu$ L
Detection	PAD, 0.05 V

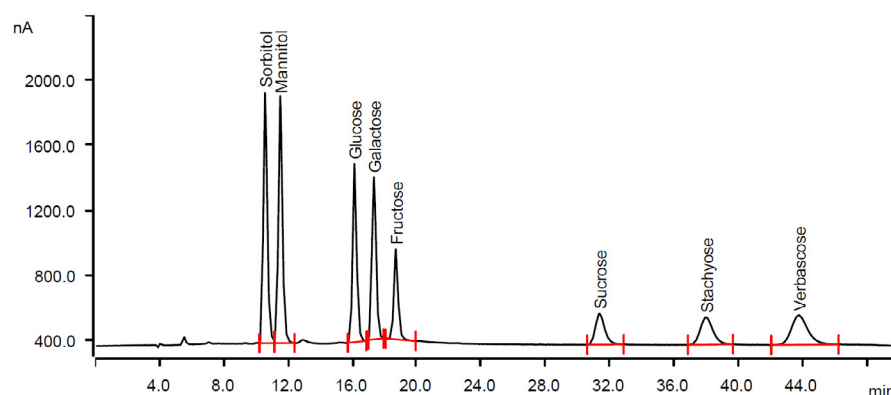

Amperometric signal for the analysis of a mixed standard with sorbitol, mannitol, glucose, galactose, fructose (25  $\mu$ mol/L each), sucrose (12.5  $\mu$ mol/L), stachyose, and verbascose (10  $\mu$ mol/L each). Raffinose eluted after 36 minutes (data not shown).

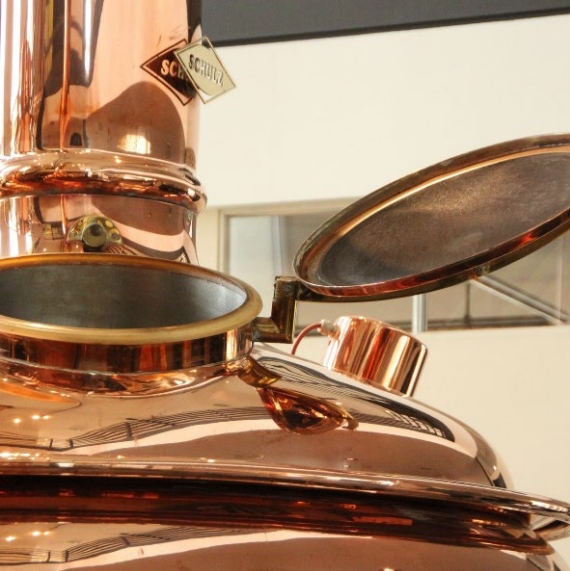

# Beverage

## Controlling beer quality - carbohydrate analysis in beer wort

### SUMMARY

When producing beer, germinated and dried cereal grains (typically barley) are subjected to a fermentation process. Enzymes convert the grain's starch into carbohydrates, including the monosaccharide glucose, the disaccharide maltose, the trisaccharide maltotriose, and the polysaccharide maltodextrin. Proteins, free amino acids, vitamins, and minerals are also present. Knowledge about the carbohydrate profiles helps to control the process and improve the beer quality.

The presented IC method monitors different carbohydrates of interest. Samples were diluted and their sugar components were separated on a Metrosep Carb 2 column with a Dose-in gradient within 60 minutes. Carbohydrates from mono-saccharides up to hexaoses were determined in one run with pulsed amperometric detection (PAD).

### SAMPLES AND SAMPLE PREPARATION

- Beer wort
- Filtered and diluted

### MISP

- Inline Dilution
- Inline Ultrafiltration

### EXPERIMENTAL

After Inline Dilution and Ultrafiltration, injection volumes of only 1.5  $\mu\text{L}$  were required as high concentrations of carbohydrates are present in the samples. Due to this, matrix effects are minimized, and the system was unaffected by contamination for an extended time period. For optimal separation a Dose-in gradient was applied to the diluted samples (1:100). After 35 minutes with eluent A (100 mmol/L NaOH + 25 mmol/L NaOAc), 95% of eluent B (220 mmol/L NaOH + 200 mmol/L NaOAc) was

added, to accelerate later eluting carbohydrates to achieve a total analysis time of approx. 60 min.

### RESULTS

Due to the excellent detector sensitivity, signals were well above the detection limits, even with low injection volumes of diluted samples. As expected, maltose was the predominant carbohydrate, with concentrations around 50 g/L. Analysis of maltoheptaose will also be possible but it was not present in this sample.

### BENEFITS

- Determination of monosaccharides and oligosaccharides in one analysis
- Dose-in gradient accelerates the elution of oligosaccharides
- Sensitive detection of low concentrations next to high concentrations of e.g., maltose

Metrosep Carb 2 - 250/4.0	
Eluent	Dose-in gradient (NaOH + NaOAc)
Flow	0.7 mL/min
Temp	30 °C
Injection	1.5 $\mu\text{L}$
Detection	PAD, 0.05 V

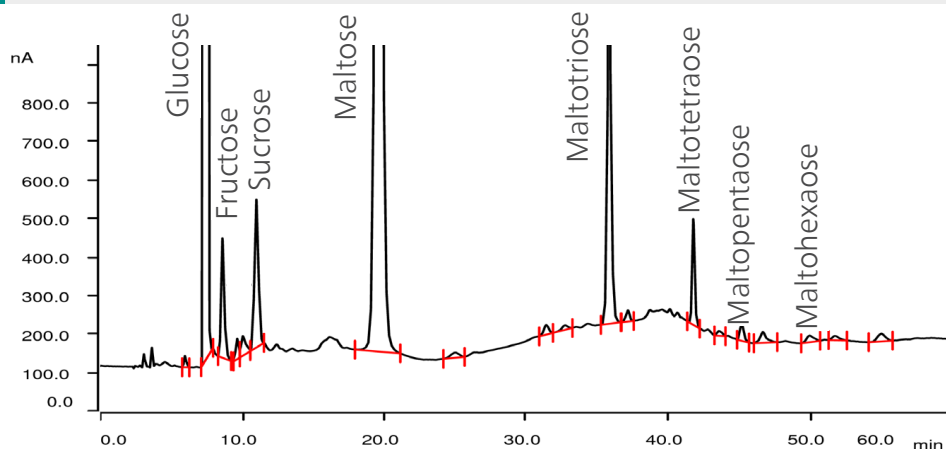

Amperometric signal of a beer wort sample at the effluent of a boiler (diluted 100-fold), containing per 100 mL: glucose (0.85 g), fructose (0.15 g), sucrose (0.38 g), maltose (4.81 g), maltotriose (1.22 g), maltopentaose, and maltohexaose (0.07 g each).



# Beverage

## Aspartame, cyclamate, acesulfame-K, and saccharin in soft drinks

### SUMMARY

Artificial sweeteners like aspartame (E 951), acesulfame-K (E 950), cyclamate (E 952), and saccharin (E 954) are added to foodstuffs to reduce calories and sugar content while keeping a consistently sweet taste. They are used worldwide in various products even though adverse health effects are being discussed. Strict regulations and labelling are mandatory in many countries, e.g., the acceptable daily intake (ADI) for aspartame is set to 40 mg/kg body weight [3]. ADI for saccharin is between 0–5 mg/kg [4]. Sodium cyclamate's ADI is suggested between 0–11 mg/kg in EU and China, while it is prohibited in the US [5].

IC with suppressed conductivity and UV/VIS detection in series is a sensitive and highly specific method to determine the four most common sweeteners, aspartame, acesulfame-K, cyclamate, and saccharin, in a variety of soft drinks.

### SAMPLES AND SAMPLE PREPARATION

- Coca-Cola™ Zero, Red Bull™ sugar free, Pepsi™ Max
- Samples were degassed and diluted (dilution factor 5–10)

### MISP

- Inline Dilution

### EXPERIMENTAL

The Metrosep A Supp 10 column is suitable to separate the sweeteners from many water-soluble components found in typical beverage matrices. The separation was optimized by combining a concentration gradient using a Metrohm Dosino (Dose-in gradient) and a flow gradient to accelerate late-eluting matrix components. The conductivity signal was evaluated after suppression. The UV signal at 210 nm was recorded in series to confirm peak identities and to evaluate the conductivity signal.

### RESULTS

Samples were analyzed in triplicate with RSDs <1%. Aspartame and acesulfame-K were present in all samples, whereas cyclamate was only found in Coca-Cola™ Zero. Saccharin was not detected. Inorganic anions (e.g., chloride, nitrate, sulfate, and phosphate) as well as organic acids (e.g., formate, acetate, benzoate, citrate) were separated from the sweeteners to avoid potential interferences.

### BENEFITS

- Two complementary detectors used for peak identification and quantification without any doubt
- No interference from common anions and other matrix components in soft drinks, e.g., citric acid or phosphate

#### Metrosep A Supp 10 - 75/4.0

Eluent	Dose-in gradient (NaOH + NaOAc + methanol)
Flow	1.0 – 1.2 mL/min
Temp	35 °C
Injection	20 µL
Detection	Conductivity + UV

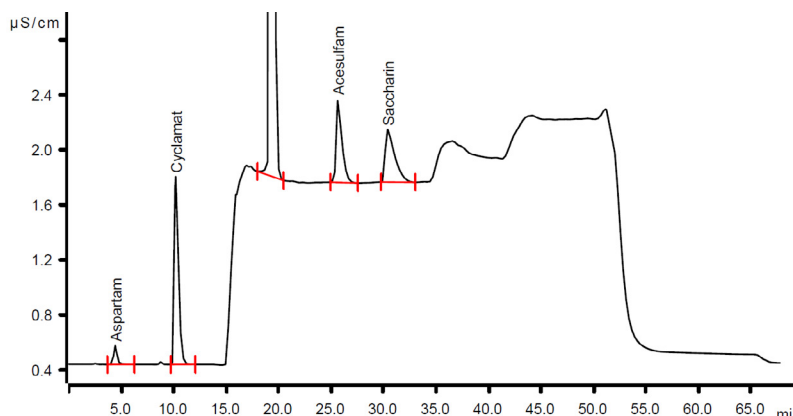

Conductivity signal of a standard containing aspartame, cyclamate, acesulfame-K and saccharin (20 mg/L each). Automatic calibration by Metrohm Inline Dilution of the highest standard can be applied (optional).



All four sweeteners showed signals in the conductivity detector and good UV absorption (except for cyclamate\*, see table below). Therefore, the UV signal was used for confirmation of the three sweeteners aspartame, acesulfame-K, and saccharin. Quantification with both detectors gave consistent results (see table below). The figure to the right displays typical chromatograms for a Red Bull™ sample (5-fold dilution).

Potential interferences from phenylalanine and taurine were also investigated. These components become protonated in the suppressor module and leave the system during suppressor regeneration. They do not interfere with the analysis.

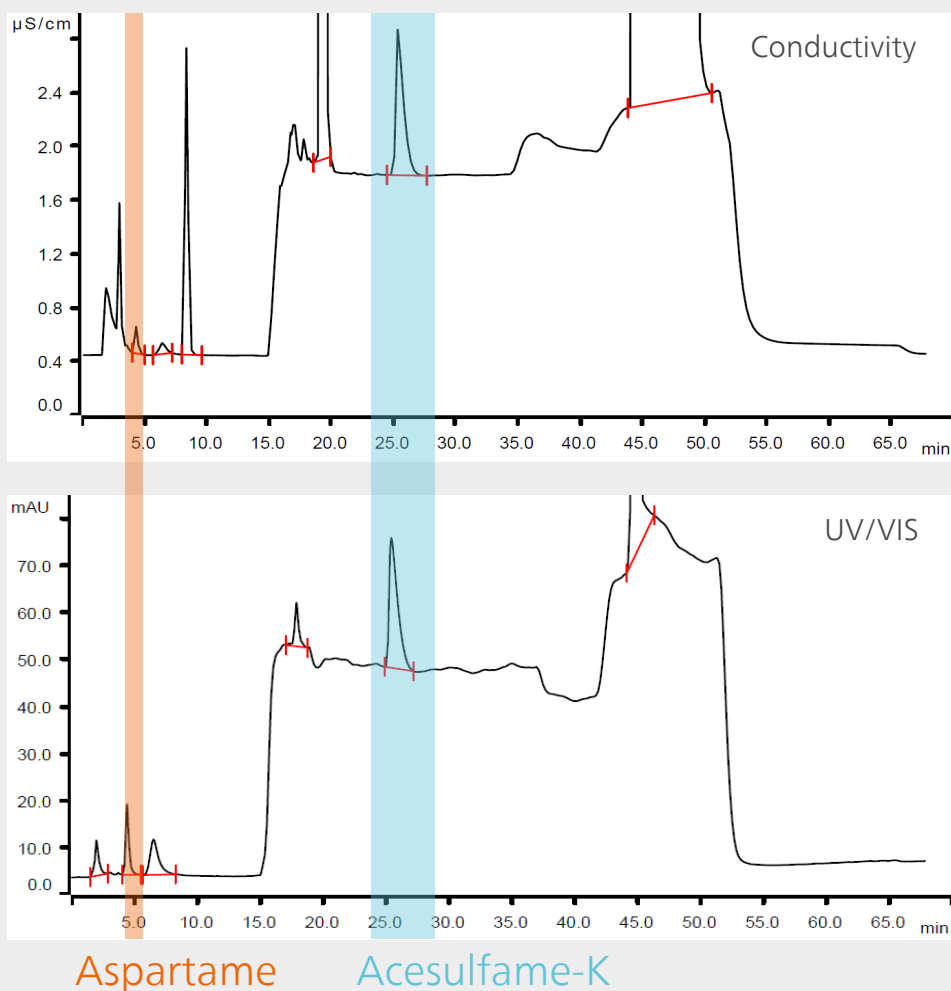

Comparison of the conductivity signal (upper panel) and UV signal (lower panel) of a Red Bull™ sample (5-fold dilution). The signal for aspartame (orange) and acesulfame-K (blue) are highlighted.

Sample	Sweetener	Conductivity [mg/L]	RSD [%]	UV 210 nm [mg/L]	RSD [%]
Red Bull™	aspartame	106.76	0.2	100.75	0.6
	acesulfame-K	195.24	0.1	197.62	0.2
Pepsi™ Max	aspartame	746.43	0.3	740.99	0.3
	acesulfame-K	51.07	0.6	54.92	1.2
Coca-Cola™ Zero	aspartame	92.25	0.5	111.12	0.7
	cyclamate	229.61	0.1	not detected*	—*
	acesulfame-K	145.77	0.3	158.89	0.7

Data summary for the evaluation of three soft drink samples. Results for conductivity and UV detection were comparable.



# Beverage

## Sucralose in soft drinks

### SUMMARY

Sucralose (E955) is an artificial sugar substitute produced from sucrose by replacing three hydroxyl groups with chlorine atoms. It is noncaloric [6], 320 to 1000 times sweeter than sucrose [7], and does not promote tooth decay [8]. Since it is considered safe by regulatory bodies such as FDA, WHO, and the EU's Scientific Committee on Food, it is added as an artificial sweetener to many foods and beverages.

As detailed metabolic pathways of artificial sweeteners and their effects on health are still not fully understood, it is good practice to monitor their content in foodstuffs.

This IC method is a robust and simpler alternative to commonly used mass spectrometric methods, e.g., HPLC-MS. Isocratic separation requires just one high-pressure pump. By utilizing amperometric detection, high selectivity and sensitivity can be achieved.

### SAMPLES AND SAMPLE PREPARATION

- Soft drink with 11 g sugar per 100 mL
- Sugar-free energy drink
- Degassed (10 minutes sonication)

### MISP

- Inline Dilution (20-fold)

### EXPERIMENTAL

Degassed and diluted samples were automatically injected into a 930 Compact IC Flex. Their ionic components were isocratically separated on a Metrosep A Supp 17 column and their sucralose content quantified with pulsed amperometric detection (PAD). Inline Dilution enabled fast and accurate automated sample dilution. Additionally, Inline Dilution was used for automatic calibration from a single standard solution by applying different

dilution factors to this solution.

### RESULTS

The analyzed samples contained up to 100 mg/L sucrose. Linear calibration from 0.5 to 25 mg/L sucralose was achieved with a correlation coefficient of  $>0.9999$  and  $<1.7\%$  RSD. Spiking tests with 5 mg/L sucralose resulted in recoveries of  $\approx 99.5\%$ .

### BENEFITS

- Robust and straightforward method with IC and PAD detection
- Isocratic separation of sucrose from other carbohydrates
- High accuracies proven by good recoveries of spiking tests

#### Metrosep A Supp 17 - 100/4.0

Eluent	125 mmol/L NaOH + 5% acetone
Flow	0.6 mL/min
Temp	45 °C
Injection	20 $\mu$ L
Detection	PAD, 0.05 V

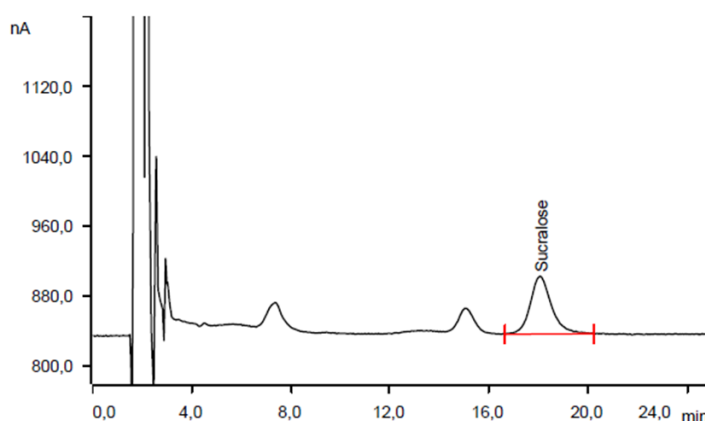

Amperometric signal from the analysis of an energy drink (20-fold dilution) containing sucralose (4.8 mg/L). Automatic calibration by Inline Dilution of the highest standard can be applied (optional).



# Beverage

## Rebaudiosides and stevioside in stevia sweetener

### SUMMARY

Steviol glycosides from the plant *Stevia rebaudiana* have been used as sweetener and sugar substitutes for more than 1000 years. The main components stevioside and rebaudioside are 30 – 150 times sweeter than sugar and do not metabolize in the human body, i.e., they do not contribute calories [9].

Discussions about safety or toxicity of stevia is reflected in a long history of regulations. Its legal status differs from country to country.

High-purity *Stevia* glycosides are allowed as ingredients in food products sold in the United States. However, *Stevia* leaves and crude extracts are not considered safe according to the US FDA.

This IC method shows the quantification of the active ingredients rebaudioside A, rebaudioside C, and stevioside in *Stevia* sweeteners.

### SAMPLES AND SAMPLE PREPARATION

- Stevia powder (97% Rebaudioside A), Kräuterhaus Sanct Bernhard, Germany
- Steviasol, powder, Steviasol AG Herisau, Switzerland
- Zucristevia, pastilles, Migros AG Zurich, Switzerland
- 100 mg dissolved in 10 mL eluent, further manual dilution 20- or 100-fold

### EXPERIMENTAL

Glycosides from *Stevia* were separated on a Luna® 5 µm C18(2) 100 Å, LC Column 250 x 4.6 mm, Ea from Phenomenex. After post-column addition of 400 mmol/L NaOH, a 945 Professional Detector Vario – Amperometry was used in flexIPAD mode. A 2 mm gold working electrode ensured signal stability. Stevia powder was used as reference standard.

### RESULTS

Rebaudioside A was quantified in steviasol (415 g/kg) and in Zucristevia (142 g/kg). Inulin, sodium bicarbonate, and sodium citrate eluted in a single peak at the beginning of the chromatogram. Common carbohydrates eluted with the injection peak.

The modes flexIPAD and standard PAD were compared, as well as the recording of current or charge. The flexIPAD mode while measuring the current showed the best signal-to-noise ratio.

### BENEFITS

- Robust separation of rebaudiosides and stevioside
- Upgrade of any HPLC-system with a Metrohm amperometric detector for sensitive glycoside analysis
- FlexIPAD mode guarantees highest sensitivity for the analysis of *Stevia* products

Luna® 5 µm C18(2) 100 Å	
Eluent	10 mmol/L NaH <sub>2</sub> PO <sub>4</sub> , pH 4.5 30% acetonitrile
Flow	0.3 mL/min
Temp	40 °C
Injection	20 µL
Detection	flexIPAD

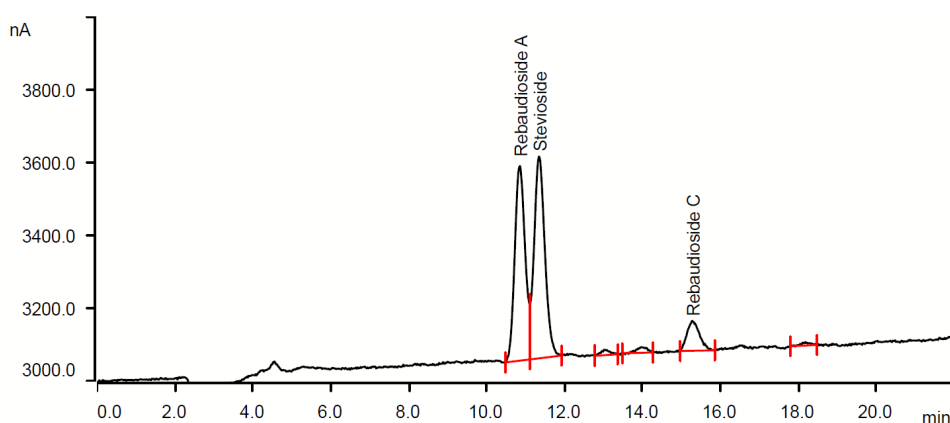

Amperometric signal for steviasol analysis showing rebaudioside A (415 g/kg), stevioside, and rebaudioside C (not quantified). The measuring mode flexIPAD was used and the current was recorded as measuring signal.

# Beverage

## Monitoring beer quality - cations and anions in beer



### SUMMARY

The ionic composition has massive influence on the taste of beer. Thus, potassium chloride salts lead to a bitter, astringent, and soapy taste while magnesium sulfates lead to a sweet-sour taste.

Therefore, analytical monitoring of the beer is essential to guarantee quality and meet consumer expectations.

Major cations in beer are precisely determined with IC and non-suppressed conductivity detection. Anions are quantified by suppressed conductivity. With a two-channel system, cations (separated on a Metrosep C 6 column) and anions (separated on a Metrosep A Supp 10 column) can be determined simultaneously. Automatic calibration, logical dilution, and filtration of the samples save manual preparation steps and ensure fast analysis of samples in high-throughput laboratories.

### SAMPLES AND SAMPLE PREPARATION

- Beer from different brands, e.g., Warsteiner™
- Filtration and dilution automatically controlled

### MISP

- Logical Inline Dilution
- Ultrafiltration

### EXPERIMENTAL

An autosampler (including filtration and dilution equipment) prepares the sample for two analysis channels in such a way that anions and cations are determined in parallel from the same sample (figure next page). Two 930 Compact IC Flex systems were used to simultaneously analyze cations (results below) and anions (next page) under isocratic elution conditions. MagIC Net software allows calibration using a single standard solution and performs

logical dilutions, saving lab work and time. High accuracy is achieved with an optimized calibration fit over a broad concentration range (feature: high-low calibration).

### RESULTS

As the main cation constituent potassium (K<sup>+</sup>) was identified in all samples, while the concentration of other cations was lower than 100 mg/L (see figure below). K<sup>+</sup> in beer provides a bitter and astringent taste.

Chloride, phosphate, nitrate, and sulfate were the main anions detected in beer. Samples can be injected with the most suitable injection volume. Together with logical dilutions, sample concentrations in the range of 1:10,000 can be analyzed reliably. High accuracy of results is achieved by an optimal fit for the calibration points (feature: high-low calibration).

Metrosep C 6 - 150/4.0	
Eluent	2.3 mmol HNO <sub>3</sub> + 1.7 mmol/L DPA
Flow	0.9 mL/min
Temp	35 °C
Injection	20 µL
Detection	Conductivity

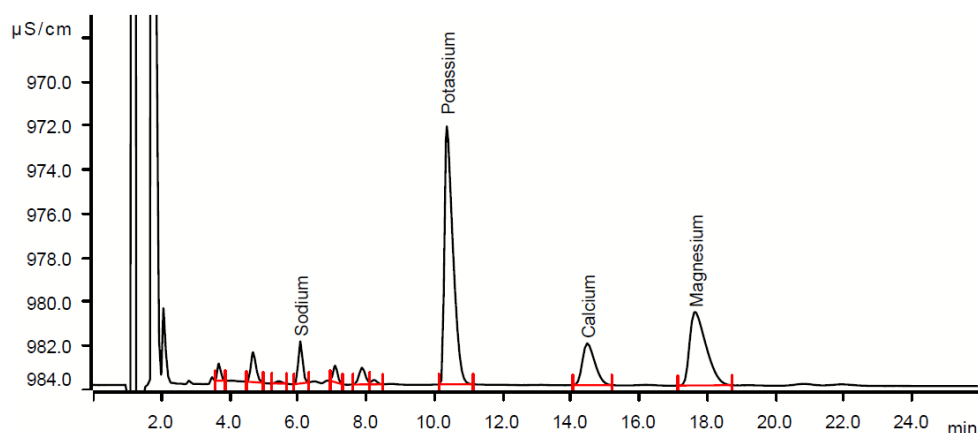

Non-suppressed conductivity cation signal for the analysis of a Warsteiner lager beer sample (10-fold dilution) containing sodium (13 mg/L), potassium (365 mg/L), calcium (53 mg/L), and magnesium (56 mg/L) as major cations.



# Beverage

## Cations and anions in beer

### BENEFITS

- Simultaneous analysis of multiple anions and cations in one run
- Automatic logical Metrohm Inline Dilution saves time and manual work
- Samples with results outside the calibration range are automatically re-diluted to fit into the calibration range
- High-low calibration for precise results of samples over a wide concentration range
- Robust and simple method with isocratic elution to determine main anions and cations in beer
- Sulfite, a common preservative can be determined next to other anions (retention time  $\approx 11$  minutes)

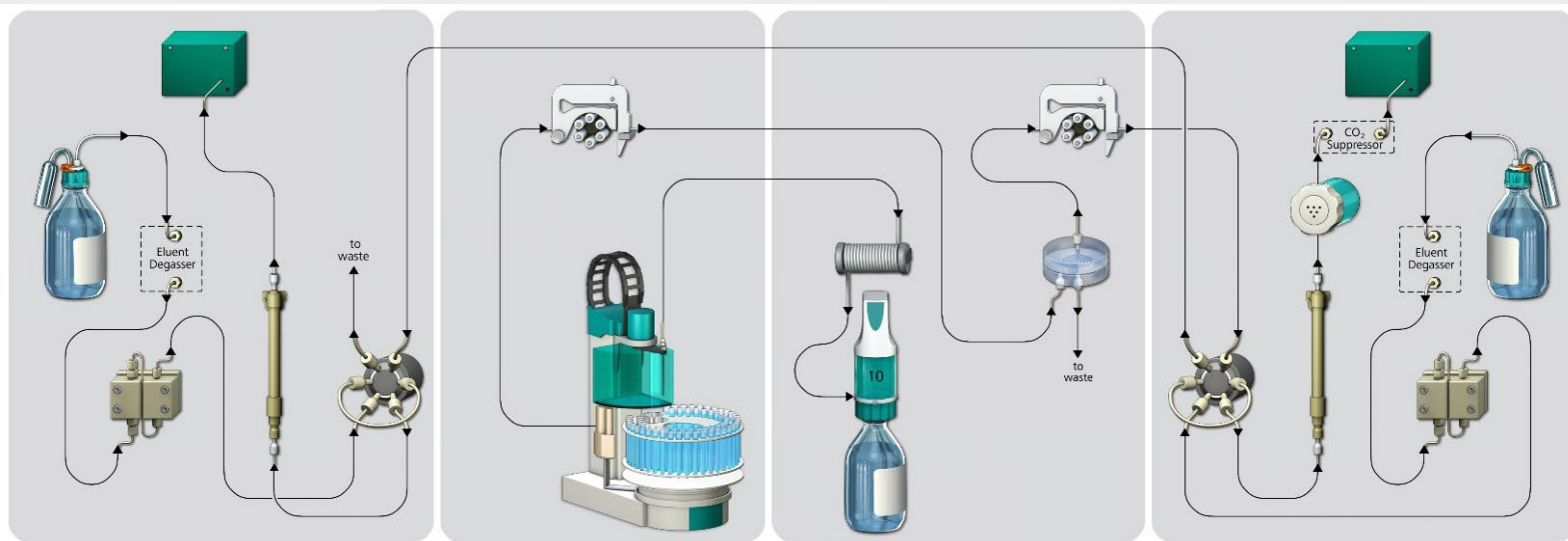

Schematic flow path for simultaneous analysis of anions and cations with Metrohm Inline Sample Preparation (MISP).

Metrosep A Supp 10 - 100/4.0	
Eluent	4 mmol Na <sub>2</sub> CO <sub>3</sub> + 6.0 mmol/L NaHCO <sub>3</sub> + 5.0 $\mu$ mol/L NaClO <sub>4</sub>
Flow	0.7 mL/min
Temp	30 °C
Injection	20 $\mu$ L
Detection	Conductivity

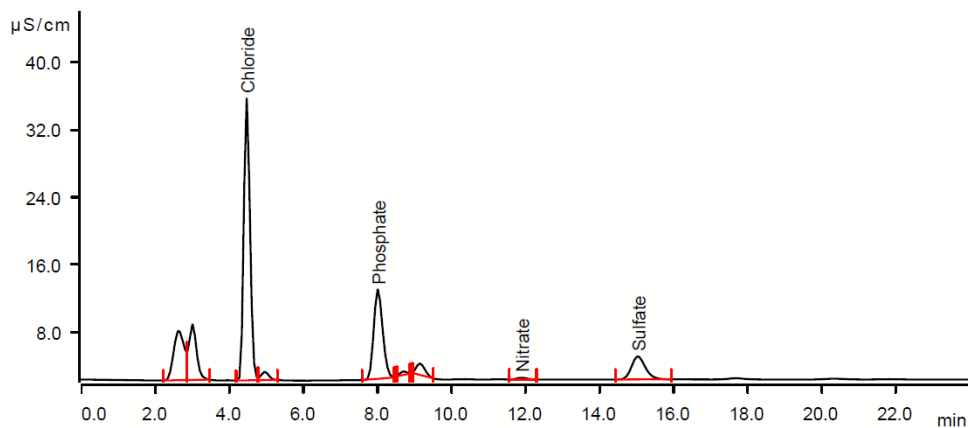

Suppressed conductivity anion signal for the analysis of a Warsteiner lager beer sample (10-fold dilution) containing chloride (229 mg/L), phosphate (352 mg/L), nitrate (5 mg/L), and sulfate (60 mg/L) as major anions.





# Beverage

## Anions and oxyhalides in drinking water

### SUMMARY

Safe drinking water is vitally important. Bottled water and mineral water are the most popular beverages worldwide. For quality control of water, IC is the method of choice for the quantification of common anions and for the analysis of regulated, health critical substances such as bromate, nitrite, chlorite, and chlorate. They enter the water supply through various pathways, such as disinfection byproducts during water treatment, additives, and artificial or natural contaminations. US EPA method 300.1 specifies the determination of these critical water components. Major standardization bodies (US FDA, WHO) regulated their allowable limits, e.g., <math><10 \mu\text{g/L}</math> bromate in drinking water [10].

The robust IC setup from Metrohm guarantees efficient analysis according to regulatory standards with high sample throughput, automation, and precise results.

### SAMPLES AND SAMPLE PREPARATION

- Drinking water, tap water
- No manual sample preparation required

### MISP

- Inline Ultrafiltration
- Partial loop injection (MiPT)

### EXPERIMENTAL

An optimized separation of bromate, bromide, chlorite and chlorate from all major anionic water components was achieved by combining a Metrosep A Supp 7 column with a Metrosep A Supp 16 guard column. The two different resins lead to a phase-optimized IC separation (POPIC). A calibration range of 1:100 was covered by applying high-low-calibration, a technique where two calibration curves are used to optimally correlate the respective signal to the concentration. Flexible injection volumes

between 4 and 200  $\mu\text{L}$  (MiPT) allowed the analysis of various water types with different mineral contents.

### RESULTS

All relevant anions in water were determined within a time frame of 35 min. The method is suitable to quantify 0.0005 mg/L chlorite and bromate in drinking water (limit of quantification).

### BENEFITS

- Compliance with US EPA 300.1 A/B
- Quantification of low concentrations of oxyhalides ( $\mu\text{g/L}$  range) next to high concentrations of other ions (mg/L range)
- Integrated Inline Ultrafiltration to minimize matrix effects
- Flexible application that can be upgraded with a mass spectrometer to further increase sensitivity

#### Metrosep A Supp 7 - 250/4.0

Eluent	3.2 mmol/L $\text{Na}_2\text{CO}_3$ 1.0 mmol/L $\text{NaHCO}_3$
Flow	0.7 mL/min
Temp	45 °C
Injection	100 $\mu\text{L}$
Detection	Conductivity

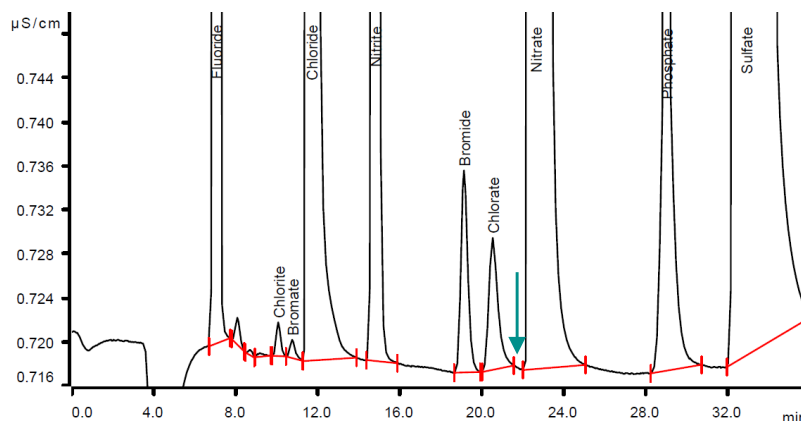

Conductivity signal of a water sample containing fluoride (0.73 mg/L), chlorite (0.002 mg/L), bromate (0.001 mg/L), chloride (2.12 mg/L), nitrite (0.135 mg/L), bromide (0.024 mg/L), chlorate (0.024 mg/L), nitrate (2.338 mg/L), phosphate (0.258 mg/L), and sulfate (8.314 mg/L). Retention time of dichloroacetate (DCA) (green arrow).



# Beverage

## Glyphosate and AMPA in drinking water

### SUMMARY

Herbicides are health critical contaminants in food. Glyphosate (N-(phosphonomethyl) glycine) is a nonselective broad-spectrum herbicide, that inhibits the shikimic acid pathway in plants. Globally, it is the most widely used herbicide in agriculture, and often used for weed-killing in domestic gardens. It reaches drinking water reservoirs through ambient air, rivers, or groundwater. Health concerns are contradictorily discussed, e.g., WHO classified glyphosate as “probably carcinogenic to humans” [11], whereas USEPA affirms that “glyphosate poses no risk to public health” [12]. Soil bacteria decompose glyphosate into its primary metabolite AMPA (aminomethylphosphonic acid), which must also be monitored.

A straightforward IC method is introduced to determine glyphosate and AMPA in the  $\mu\text{g/L}$  range with amperometric detection.

### SAMPLES AND SAMPLE PREPARATION

- Tap water of different hardness (high–low)

### MISP

- Inline sample degasser to remove dissolved carbon dioxide

### EXPERIMENTAL

Separation was on a Metrosep Carb 2 column with a flow rate of 0.4 mL/min, which was increased to 0.8 mL/min after 6 minutes to accelerate the elution of glyphosate. Detection was performed with a dedicated potential profile with flexIPAD mode. Calibration was from 2–100  $\mu\text{g/L}$  for both compounds.

### RESULTS

Limits of quantification (LOQs) were 0.4  $\mu\text{g/L}$  (AMPA) and 3.9  $\mu\text{g/L}$  (glyphosate). Inter-day precision (5 days, 13 injections) for tap water spiked with 5  $\mu\text{g/L}$

of each compound showed 3.3% RSD for both, AMPA and glyphosate. Recoveries ranged between 88–112%, with strong dependence on the type of water. Waters with lower hardness tend to show better recoveries.

### BENEFITS

- Amperometric detection proved to be selective and sensitive, offering a simple and economical alternative to more complex MS/MS or ICP/MS methods [13]
- Robust and easy analytical method for AMPA and glyphosate determination in the  $\mu\text{g/L}$  range
- Fulfills USEPA LOQ (0.7 mg/L for glyphosate) [14]
- Fulfills current LOQs for regulations of glyphosate in Canada (280  $\mu\text{g/L}$ ), Australia (10  $\mu\text{g/L}$ ), and Brazil (500  $\mu\text{g/L}$ ) [15]

Metrosep Carb 2 - 100/4.0	
Eluent	10 mmol/L NaOH + 290 mmol/L NaOAc
Flow	Flow gradient (0.4 – 0.8 mL/min)
Temp	30 °C
Injection	250 $\mu\text{L}$
Detection	flexIPAD

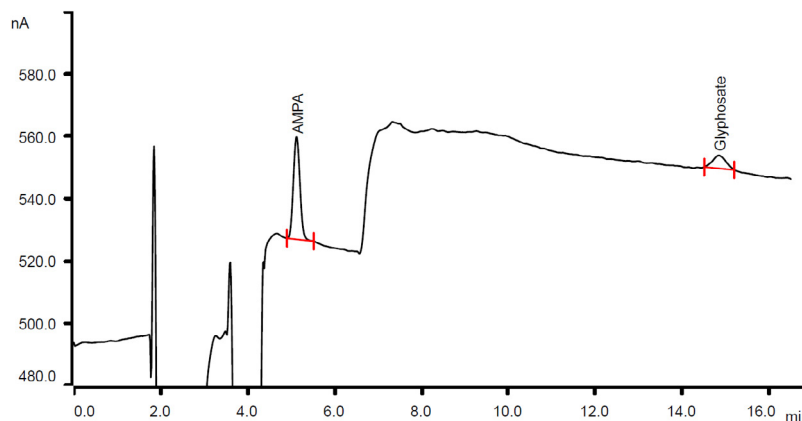

Amperometric signal of a tap water sample spiked with AMPA and glyphosate (5  $\mu\text{g/L}$  each). Recoveries were 85.0% (AMPA) and 99.6% (glyphosate).



# Beverage

## Fast screening of organic acids and inorganic anions in wine

### SUMMARY

Consistency of product quality is of utmost importance to winemakers. Monitoring yeast performance and efficiency throughout the fermentation process is just as critical. This wine analysis can aid winemakers with ensuring predictable flavor and aroma characteristics in finished wine by monitoring common indicators of acidity, mouthfeel, and balance. It also evaluates nutrients and other additives which could potentially have negative effects on efficiency and production during the fermentation process. This work shows the use of Metrohm IC to analyze red and white wine for chloride, phosphate, sulfite, sulfate, malate, tartrate, and oxalate.

A Metrohm Professional IC with sequential suppression and conductivity detection was used in combination with Inline Ultrafiltration.

### SAMPLES AND SAMPLE PREPARATION

- Red wine, white wine
- Gravimetrically diluted 1:10 or 1:50 with ultrapure water
- To prevent oxidation, vials were closed with polyethylene lids

### MISP

- Inline Ultrafiltration

### EXPERIMENTAL

Samples were directly analyzed after dilution and Inline Ultrafiltration. Separation of organic acids (as their conjugated bases) and inorganic anions was performed with a Professional IC system equipped with sequential suppression and a conductivity detector. Suppression reduces the background signal and the baseline noise and improves detection sensitivity. The method working range spans from 1–100 mg/L.

### RESULTS

All major organic acids and inorganic anions were separated isocratically within a run time of 20 minutes. Tartrate and acetate were identified as the major organic acid species. Injections of triplicates showed an excellent repeatability with RSDs of less than 2%. Phosphate and sulfate were identified as the dominant inorganic anions.

### BENEFITS

- Inline Ultrafiltration protects the column and system, increasing lifetime and ensuring trouble-free operation, and reduces manual work
- Rapid analysis enables high throughput laboratories to maximize production
- Robust setup with isocratic separation and suppressed conductivity detection for sensitive analysis

#### Metrosep A Supp 10 - 100/4.0

Eluent	5 mmol/L Na <sub>2</sub> CO <sub>3</sub> + 5 mmol/L NaHCO <sub>3</sub> + 5 μmol/L HClO <sub>4</sub>
Flow	1.0 mL/min
Temp	35 °C
Injection	20 μL
Detection	Conductivity

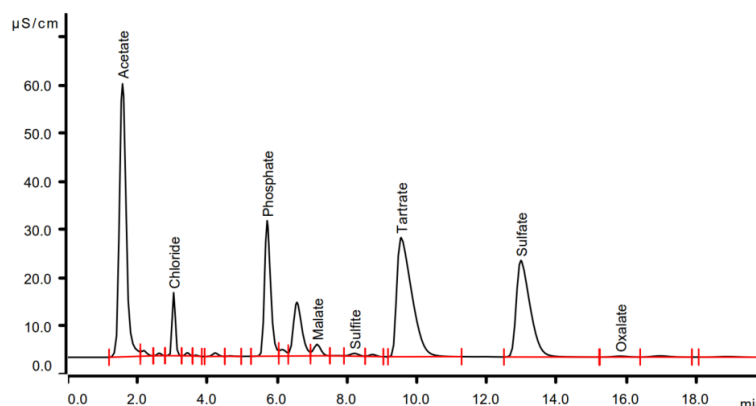

Conductivity signal for analysis of major organic acids (acetate (not quantified), malate (105 mg/L), tartrate (1534 mg/L), oxalate (<10 mg/L)) and major anions (chloride (22 mg/L), phosphate (818 mg/L), sulfite (29 mg/L), and sulfate (367 mg/L)) in a white wine sample.



# Beverage

## Complex monitoring of organic acids and inorganic anions in wine

### SUMMARY

Nature and concentration of organic acids are important parameters in enology. They affect organoleptic properties (color, flavor, and aroma), wine stability, and help to track alteration processes and the wine's authenticity [16]. A range of organic acids are formed as products during alcoholic fermentation influencing flavor in many ways. Acetic acid for example causes an undesirable vinegar taste. Overall, monitoring of organic acids is crucial to improve flavor and quality, and to fulfill universal standardized criteria such as the International Code of Oenological Practices [17].

Analytical monitoring of multiple organic acids can be achieved with IC and suppressed conductivity detection. Optionally, a mass detector can be added for peak verification. Here, a binary gradient on a Metrosep A Supp 7 - 250/4.0 column was used to separate 15 organic acids.

### RESULTS

The method enables complex monitoring analysis of 15 organic acids in a working range of 0.1–5 mg/L. Sample preparation can be facilitated with Inline Ultrafiltration, protecting the column and enhancing instrument performance (figure below). If peak identity needs confirmation, or very low detection limits are required, the

IC setup can be combined with a sensitive MS detector.

### BENEFITS

- Conductivity detection prevents interferences from UV-active components in wine
- Optional extension with inline sample preparation to save time
- Optional addition of a mass detector for peak identification

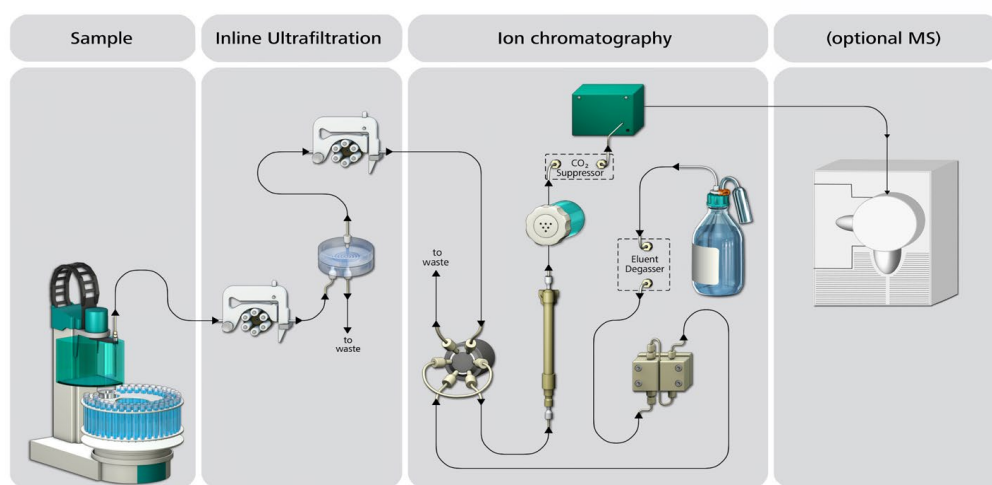

Schematic flow path for IC with Inline Ultrafiltration and suppressed conductivity detection. To achieve higher sensitivity and peak confirmation the system can be upgraded with a mass spectrometer (MS).

### Metrosep A Supp 7 - 250/4.0

Eluent	A: ultrapure water B: 6.4 mmol/L Na <sub>2</sub> CO <sub>3</sub> + 2.0 mmol/L NaHCO <sub>3</sub>
Flow	0.7 mL/min
Temp	45 °C
Injection	20 µL
Detection	Conductivity

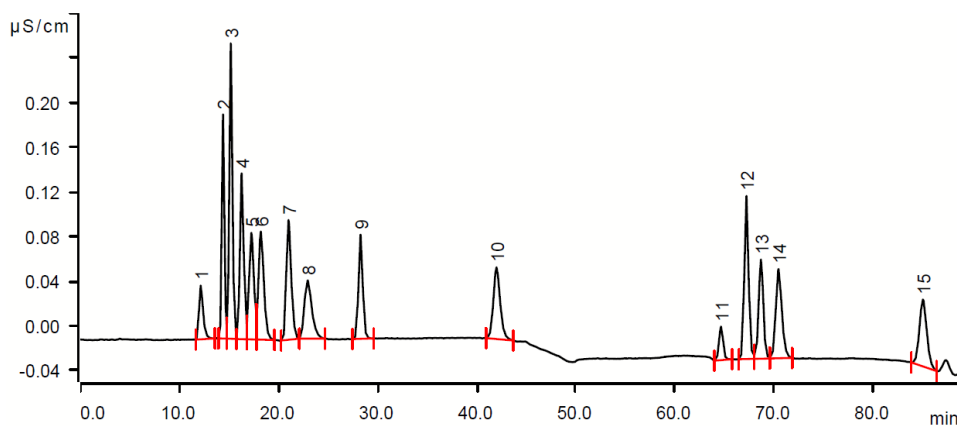

Signal of 1 mg/L gluconate (1), lactate (2), acetate (3), propionate (4), iso-butyrate (5), butyrate (6), methacrylate (7), valerate (8), methylsulfate (9), dichloroacetate (10), malonate (11), malate (12), glutarate (13), adipate (14), and phthalate (15).



# Beverage

## Preventing food allergies - Biogenic amines and cations in wine

### SUMMARY

During the wine manufacturing process, production conditions, storage times, as well as possible microbiological contamination play a role in the content of biogenic amines. Histamine is most harmful to sensitive people and a known reason for food intolerances; however, other amines also exhibit adverse effects. The histamine content for wine is often not regulated by law but recommended to not exceed limits of 2–10 mg/L, depending on the country [18].

Nine (biogenic) amines and six inorganic cations were separated on a Metrosep C Supp 1 column, using a binary gradient. Suppressed conductivity guarantees sensitive detection. Hence this IC method offers a robust and reliable way to determine these compounds in wine for quality control.

### SAMPLES AND SAMPLE PREPARATION

- Red wine (Primitivo dal Salente 2014 – Cesario)

### MISP

- Inline Dilution
- Inline Ultrafiltration

### EXPERIMENTAL

Samples were automatically diluted and filtered inline before injection into the IC system. A binary high-pressure gradient (940 Professional IC with HPG specification) was used to minimize co-elution, to separate matrix and analytes, and to achieve a reasonable overall recording time. Sequential suppression was used to reduce the background signal and background noise which is important to keep sensitivity especially for gradient systems. With this setup, nine amines were

detected next to the standard cations in the lower mg/L range.

### RESULTS

The amines analyzed are shown in the chromatogram below. In the red wine sample, calcium and magnesium were identified as major inorganic cations. Lower amounts of monomethyl- and triethylamine were detected. The allergen histamine was not detected in the investigated samples.

### BENEFITS

- Minimized matrix effects and fully automated sample preparation due to Inline Dilution and Inline Filtration
- Excellent separation with a binary gradient in a reasonable analysis time
- Sensitive cation detection with suppressed conductivity

#### Metrosep C Supp 1 - 150/4.0

Eluent	A: 2.5 mmol/L HNO <sub>3</sub> + 100 µg/L Rb <sup>+</sup> B: 25 mmol/L HNO <sub>3</sub> + 100 µg/L Rb <sup>+</sup>
Flow	1.0 mL/min
Temp	40 °C
Injection	100 µL
Detection	Conductivity

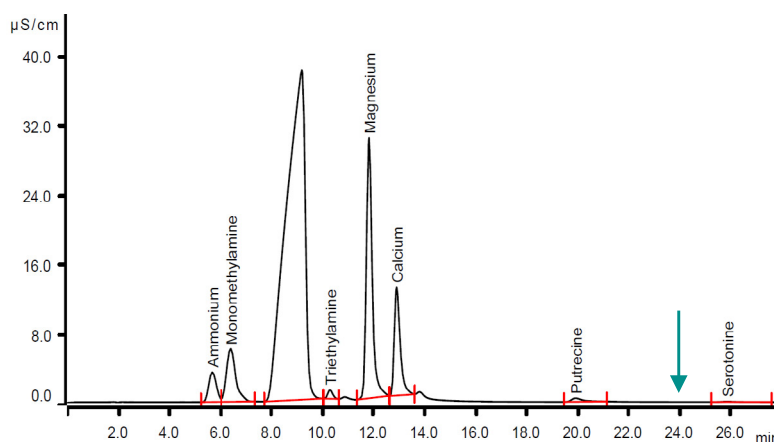

Red wine sample (12.5-fold dilution) containing ammonium (26 mg/L), monomethylamine (106 mg/L), triethylamine (47 mg/L), magnesium (153 mg/L), calcium (153 mg/L), putrescine (24 mg/L), and serotonin (5 mg/L) as major cations. Monoethylamine, potassium, diethylamine, 2-phenyl-ethylamine, cadaverine, and histamine (arrow) were not detected.

# Additives, preservatives, nutrients

## Nitrite and nitrate in meat



### SUMMARY

Nitrite and nitrate salts are used as preservatives for meat and meat products. They are labeled on foods as E249–E252. These so-called curing salts prevent bacterial growth, keep the meat's red color and enhance its flavor. Nitrate salts (E 251, E 252) have low toxicity. However, long-term exposure is of concern, as nitrate is reduced to nitrite in the lower gut, and nitrite is a precursor of nitrosamines, which are classified as carcinogenic [19]. Nitrite is classified as probably carcinogenic to humans [20]. MPL (maximum permitted levels) after the manufacturing process vary for nitrite (E 249, E 250) between 50–180 mg/kg, and for nitrate between 150–300 mg/kg, depending on the product.

For quality control, IC offers a highly sensitive, robust, and fast method for nitrate and nitrite analysis in various meat products.

### SAMPLES AND SAMPLE PREPARATION

- Meat, sausages, beverages, vegetables (5 g homogenized)
- Carrez precipitation
- Diluted 100-fold, filtered

### MISP

- Inline Ultrafiltration

### EXPERIMENTAL

Analytes were separated by isocratic anion exchange on two columns in series, followed by sequential suppression and UV/VIS detection. The two columns with different properties were used in series to avoid co-elution of nitrite with other components. A temperature of 52 °C further improved the resolution of the nitrite peak.

### RESULTS

The calibrated range for nitrite was 0.02–2.00 mg/L, and for

nitrate 0.05–5.00 mg/L. A wide variety of food and beverage samples were evaluated, showing symmetric peaks, high reproducibility of the concentration values, and negligible interferences from matrix compounds. Limits of quantification were well below 5 mg/kg for sodium nitrite and sodium nitrate in all tested samples.

### BENEFITS

- Fast and time-saving routine analysis, without requiring sample preparation cartridges
- High accuracy and reproducibility independent from the food matrix
- Automation and robustness surpass analytical performance of classical HPLC-UV
- Approved method in quality-control labs of the meat industry

Metrosep A Supp 7 - 250/4.0 + Metrosep A Supp 5 - 50/4.0	
Eluent	3.6 mmol/L Na <sub>2</sub> CO <sub>3</sub> + 15% methanol
Flow	0.7 mL/min
Temp	52 °C
Injection	50 µL
Detection	UV 205 nm

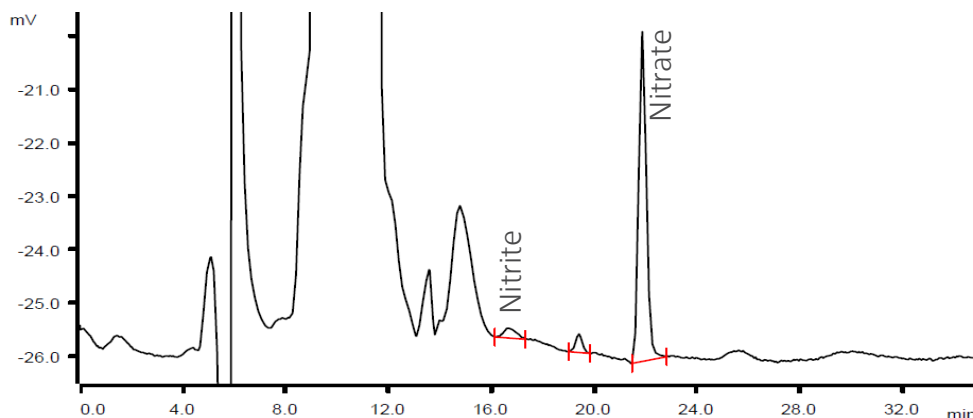

Chromatogram of a sample from pork knuckle containing sodium nitrite (1.5 mg/kg) and sodium nitrate (9.6 mg/kg).



# Additives, preservatives, nutrients

## Polyphosphates in shrimps

### SUMMARY

Polyphosphates improve the water-binding capacity, appearance, and texture of food products. They are often used in the production of seafood, such as shrimps, and also added to convenience food, boiled sausages, cheese products, soft drinks, bakery products, or cereals as stabilizers and flavor enhancers. Labeling is required (e.g., E 450 – E 452) and the ADI (acceptable daily intake) of total phosphates is set to 40 mg/kg body weight by the European Food Safety Authority (EFSA) [21].

The IC method presented here shows a fast and straightforward way to quantify pyrophosphate, tripolyphosphate, and trimetaphosphate in shrimp. Inline sample preparation helps to minimize manual sample preparation steps. Additionally, samples with a wide concentration variability are readily analyzed due to flexible injection volumes.

### SAMPLES AND SAMPLE PREPARATION

- Shrimp, seafood
- ≈10 g of sample homogenized, 100 mL UPW added
- Extracted in an ultrasonic bath (30 minutes, 25 °C), centrifuged (4000 rpm, 25°C, 10 min) and decanted

### MISP

- Inline Ultrafiltration
- Metrohm intelligent Partial loop Technique (MiPT)

### EXPERIMENTAL

Inline Ultrafiltration removed any remaining particles. Analysis was accomplished on a 930 Compact IC Flex with automation and inline sample preparation. For calibration, 4–200 µL of a single mix standard (pyrophosphate, tripolyphosphate 5 mg/L each; and trimetaphosphate 1 mg/L) were injected, covering a ratio of

1:50 (concentration range for pyrophosphate and tripolyphosphate 5–250 mg/L each; and trimetaphosphate 1–50 mg/L).

### RESULTS

Three polyphosphates were analyzed within a run time of 13 minutes. The sample injection volume was 4 µL and recovery rate >75%.

### BENEFITS

- Determination of the specific polyphosphate oligomers, in contrast to average chain length determined in end-group titration methods
- Flexible injection volumes to ensure that measured analytes are within the calibrated range
- Upgrade the method with a Dose-in gradient to also quantify fluoride, chloride, bromide, nitrate, phosphate, and sulfate

Metrosep A Supp 17 - 100/4.0	
Eluent	60 mmol/L Na <sub>2</sub> CO <sub>3</sub> + 2.0 mmol/L NaHCO <sub>3</sub>
Flow	0.6 mL/min
Temp	30 °C
Injection	4–200 µL (MiPT)
Detection	Conductivity

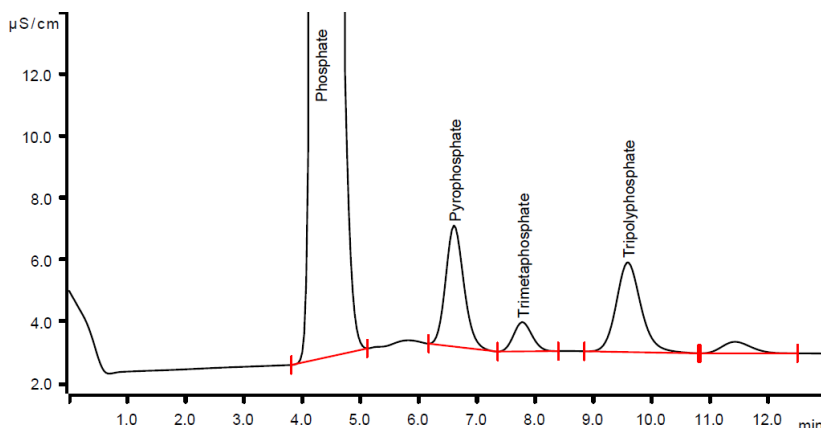

Conductivity signal of a shrimp sample that did not contain polyphosphates in the calibrated concentration range. The samples were spiked with pyrophosphate, tripolyphosphate (100 mg/L each), and trimetaphosphate (20 mg/L).

# Additives, preservatives, nutrients

## Sulfite in mustard



### SUMMARY

Sulfite is a preservative added to a vast range of foods and beverages to prevent browning or oxidation. Some individuals are sensitive to sulfite additives and may experience a range of allergic reactions. Therefore, both the U.S. Food and Drug Administration (FDA) and European Union (EU) laws require that the presence of sulfites must be declared on food labels exceeding 10 mg/kg. The permitted maximum sulfite level is <math><450\text{ mg/kg}</math> [22]. Several analytical methods exist to measure sulfite in food and beverages; however, they suffer from repeatability issues, and can be quite cumbersome to perform.

An innovative, fast, and accurate IC method is presented, based on a tailor-made mode of electrochemical detection (patent filed). Not only is it suitable for beverages, but also for solid foodstuffs [23, 24].

### SAMPLES AND SAMPLE PREPARATION

- Chickpeas, mustard, cherries, capers, canned garlic, chili peppers
- 1 g homogenized sample diluted with stabilization solution (1.0 mmol/L formaldehyde + 0.20 mmol/L NaOH) to a total of 30 g.
- Homogenized for 1 min at 25000 rpm with an ultra-turrax® homogenizer
- Centrifuged at 4000 rpm, filtered with 0.2  $\mu\text{m}$ . To avoid oxidation, vials must be filled completely with sample and tightly closed.

### EXPERIMENTAL

To guarantee sample stability, samples were cooled (6 °C) with an 889 IC Sample Center prior to injection. Optimal peak resolution was obtained with the high-capacity Metrosep Carb 2 column. The MagIC Net software

offers a command «CV treatment» (patent filed) to automatically clean the surface of the working electrode. This step increases long-term stability of the measuring signal even with highly loaded samples.

### RESULTS

The signal remained stable for long sample series and with various sample matrices. All spiking recoveries were above 90%.

### BENEFITS

- Long sample series with stable signal thanks to automatically cleaned electrodes
- No electrode deactivation or fouling for 3 weeks
- Sensitive quantification of total sulfite in many different food matrices
- High throughput with only 10 minutes analysis time

Metrosep Carb 2 - 150/4.0	
Eluent	300 mmol/L NaOH + 300 mmol/L NaOAc
Flow	0.5 mL/min
Temp	35 °C
Injection	3 $\mu\text{L}$
Detection	DC, 0.3 V

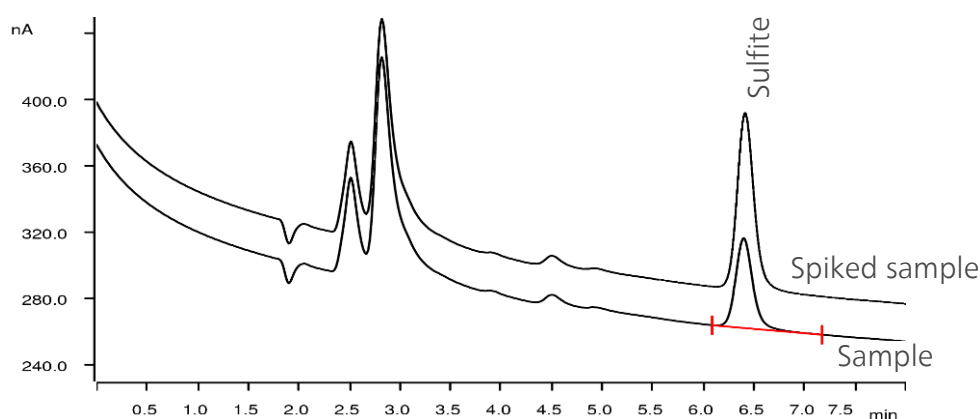

Overlay of amperometric signals for a mustard sample containing 3.2 mg/kg sulfite and the same sample spiked with 3.2 mg/kg sulfite. The recovery was 101.5 %.





# Additives, preservatives, nutrients

## Sulfur in dried fruits

### with Combustion IC

#### SUMMARY

Since ancient times, sulfurization is a method of preservation to extend shelf life and avoid degradation by microorganisms in fruits, meat, fish, vegetables, wine, and beer. Treating dry fruits with sulfur dioxide gas shortens the drying process and preserves the color of the product. However, sulfite is formed in the products which can induce allergic reactions in some people. Sulfite is banned in raw foods and must be labeled on processed foods according to EC No 1333/2008 (95/2/EC Appendix III) or CODEX STAN 192-1995, e.g., if it exceeds 500–2000 mg/kg in dry fruits.

Such high concentrations of sulfur are directly determined in solid foodstuffs with Combustion IC (CIC). Complete automation, including sample preparation, makes Combustion IC superior to offline digestion methods with regard to sample throughput and precision of the results.

#### SAMPLES AND SAMPLE PREPARATION

- Apricots: naturally dried (exposed to sunlight) or sulfur dried (exposed to sulfur dioxide gas)
- ≈75 mg sample weighed directly in a Combustion IC quartz boat

#### MISP

- Combustion IC (CIC) for solid samples

#### EXPERIMENTAL

With CIC, samples are first digested under an argon atmosphere in the oven unit and then pyrolyzed with oxygen and water (pyrohydrolysis). In the 920 Absorber Module, the formed gaseous compounds are passed into an absorption solution with hydrogen peroxide, to oxidize them. This absorption solution is then transferred inline to a

Metrohm IC where it is analyzed. The sulfate concentration relates to the total sulfur content of the sample, as all sulfur species are oxidized to sulfate with CIC.

#### RESULTS

Sulfur dried apricots (2937 mg/kg) contained over 25 times more sulfur than natural dried apricots (112 mg/kg). Analysis was reproducible with <3% RSD for triplicate injections.

#### BENEFITS

- High sample throughput, precision, and accuracy
- Fully automated sample preparation for solid and liquid samples with a single modular sample changer
- Possible to determine sulfur and halogens simultaneously
- Compliance with standards such as FDA and GLP

Metrosep A Supp 5 - 150/4.0	
Eluent	3.2 mmol Na <sub>2</sub> CO <sub>3</sub> + 1.0 mmol/L NaHCO <sub>3</sub>
Flow	0.8 mL/min
Temp	45 °C
Injection	10 µL
Detection	Conductivity

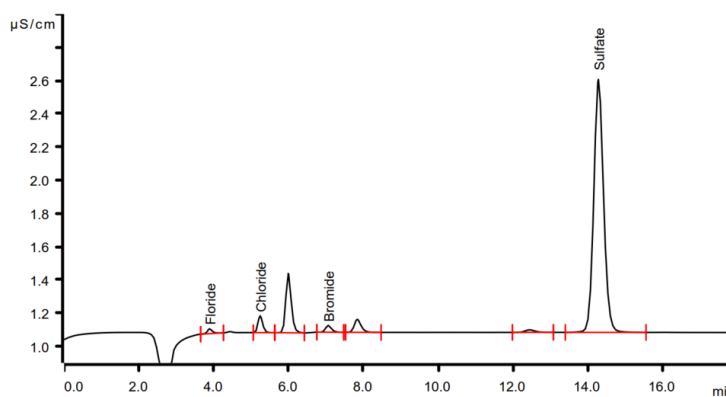

Conductivity signal of the analysis of a naturally dried apricot sample after combustion. The total sulfur content is determined as sulfate as all sulfur species are oxidized to sulfate by pyrohydrolysis. Here, 112 mg/kg sulfur was measured.



# Additives, preservatives, nutrients

## Bromate in flour

### SUMMARY

Potassium bromate is added to flour to accelerate the maturation process. This treatment improves dough properties, leading to stronger and more elastic bread. Bromate should degrade during the baking process, but residual amounts may remain when baking time is too short, baking temperatures are too low, or the amount of added bromate is too high. As potassium bromate is classified as a category 2B carcinogen (possibly carcinogenic to humans) by the International Agency for Research on Cancer (IARC), it is prohibited in any food. However, quality control is still necessary.

Low concentrations of bromate in flour are selectively and sensitively quantified with UV/VIS detection after separation on a Metrosep A Supp 7 and post-column reaction (PCR) on a 940 Professional IC Vario with a 947 Professional UV/VIS Detector Vario SW.

### SAMPLES AND SAMPLE PREPARATION

- Wheat flour
- 25 g sample suspended in 250 mL water, sonicated for 30 min at ambient temperature
- 10 mL sample aliquot centrifuged (10 min, 6000 rpm), analysis of the supernatant

### MISP

- Inline Dialysis

### EXPERIMENTAL

Inline Dialysis automatically removed matrix interferences. Pretreatment with sample preparation cartridges was not required. After chromatographic separation, a PCR reagent was added which allows the UV/VIS detection at 352 nm of bromate in the low  $\mu\text{g/L}$  range.

### RESULTS

The setup is compliant with ISO/DIN 11206. Bromate was calibrated in the concentration range of 50–2000  $\mu\text{g/kg}$ . Flour samples did not contain bromate. They were spiked with different amounts of bromate, resulting in recoveries between 94–110%.

### BENEFITS

- Selective and sensitive quantification of bromate in complex food matrices
- Sample preparation cartridges are not necessary
- Minimized sample preparation time due to Inline Dialysis
- Excellent sensitivity with the 947 Professional UV/VIS Detector Vario
- Method is compliant with ISO/DIN 11206

Metrosep A Supp 7 - 250/4.0	
Eluent	3.6 mmol/L $\text{Na}_2\text{CO}_3$
Flow	0.65 mL/min
Temp	45 °C
Injection	100 $\mu\text{L}$
Detection	UV/VIS 352 nm

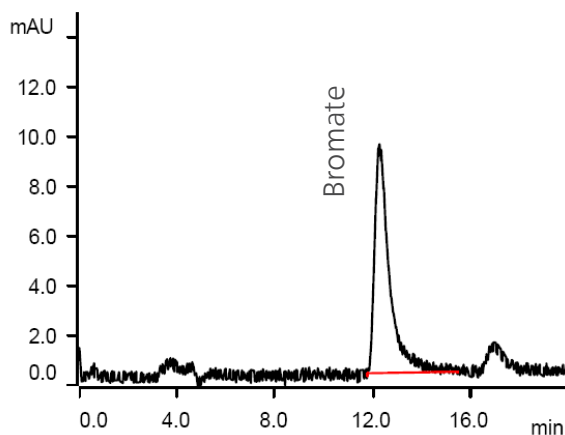

UV/VIS signal of bromate (204  $\mu\text{g/L}$ ) in flour, after separation on a Metrosep A Supp 7 column and post-column reaction with 0.5 mol/L potassium iodide.

# Additives, preservatives, nutrients Iodate in wheat powder

## SUMMARY

Potassium iodate influences the final quality of wheat-spelt baked goods in different ways. Addition of potassium iodate reduces dough development time and prolongs dough stability. Results of baking tests and sensory analyses have shown that products containing some potassium iodate have higher volume and cambering in comparison to control samples. Higher doses of this additive negatively affect sensory parameters of final products. Enrichment of baked goods with potassium iodate not only helps to increase the daily intake of iodine and but also positively affects rheological and sensory properties of final products. Here, a straightforward IC method with the Metrosep A Supp 5 column for separation and UV/VIS detector is shown to measure iodate in wheat in the mg/kg range.

## SAMPLES AND SAMPLE PREPARATION

- Two types of wheat powder
- 2 g sample dissolved in 0.1 mol/L NaOH (total volume 100 mL)
- Sonicated for 20 minutes, filtered through 0.2 µm filter, passed through IC-C18 sample preparation cartridge

## MISP

- Inline Dialysis (optional)

## EXPERIMENTAL

Samples were analyzed with an 858 Professional Sample Processor and a 930 Compact IC Flex. After separation on a Metrosep A Supp 5 column, the UV signal of iodate was quantified within the concentration range of 1–10 mg/L. Accuracy of the analysis was checked by spiking tests.

## RESULTS

IC-C18 sample preparation cartridges were necessary to remove organic matrix compounds. Two cartridges can be used in series, if required. Iodate was reproducibly determined in wheat powder in the low mg/L range. Spiking tests with 5 mg/L iodate yielded in a recovery of 102%.

## BENEFITS

- IC combined with an UV/VIS detector covers typical HPLC applications
- Sufficient separation from interfering components while keeping a short overall recording time of less than 10 minutes
- Alternative method to traditional titration (AOAC Official Method 956.03)

### Metrosep A Supp 5 - 250/4.0

Eluent	3.2 mmol Na <sub>2</sub> CO <sub>3</sub> + 1.0 mmol/L NaHCO <sub>3</sub>
Flow	0.7 mL/min
Temp	ambient
Injection	20 µL
Detection	UV 215 nm

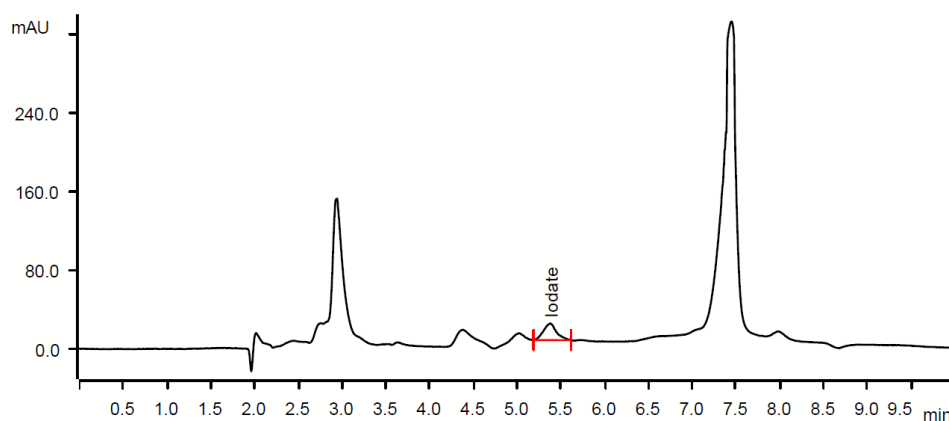

Chromatogram of the UV signal of a wheat powder sample, containing 89 mg/kg iodate.

# Additives, preservatives, nutrients

## Iodate and iodide in table salt

### SUMMARY

Table salt may contain various additives that are beneficial to humans. Iodate or iodide is often added to salt as iodine plays an important role in the production of thyroid hormone. Using iodized salt in cooking helps to overcome goiter (from a deficiency in iodine). Straw mushroom table salt contains straw mushrooms, which contribute not only various mineral substances like iodide but also vitamin C, carbohydrates, and more than 18 kinds of amino acids. Table salts are subjected to quality control and their ionic components can be quantified with IC. The determination of iodate and iodide in table salt is described in the Chinese norm SN/T 3727 [25].

The presented IC method with amperometric detection quantifies iodide in the  $\mu\text{g/L}$  range in salt samples. Dedicated sample preparation allows to differentiate between iodide and iodate.

### SAMPLES AND SAMPLE PREPARATION

- Straw mushroom table salt
- 0.1 g sample dissolved in water (total volume 100 mL)

### EXPERIMENTAL

Samples were analyzed with an 889 IC Sample Center and a 930 Compact IC Flex, using a Metrosep A Supp 7 column. Iodide was sensitively detected amperometrically using the direct current mode (DC 0.15 V). When reducing the sample with ascorbic acid (5 g/100 mL; 0.2 mL added to the sample solution), all iodate converts to iodide. Hence, total iodine content is determined in these samples. The iodate content is calculated from the difference of total iodine and the iodide (a user-defined result in the MagIC Net software).

### RESULTS

The calibration range spanned 5–100  $\mu\text{g/L}$  iodide. The reduction of iodate to iodite by ascorbic acid treatment was tested and approved with standards (500  $\mu\text{g/L}$ ). The conversion yielded >95%, approving a successful overall method performance.

Samples contained about 20 mg/kg iodide. Treatment with ascorbic acid led to the same result. Thus, total iodine content was similar, which means that all iodine was present as iodide.

### BENEFITS

- Method according to SN/T 3727-2013 from AQSIQ
- Determination of the species iodide and iodate
- Robust method that copes with various kinds of salt samples

Metrosep A Supp 7 - 250/4.0	
Eluent	9.0 mmol $\text{Na}_2\text{CO}_3$
Flow	0.7 mL/min
Temp	40 °C
Injection	100 $\mu\text{L}$
Detection	DC 0.15 V

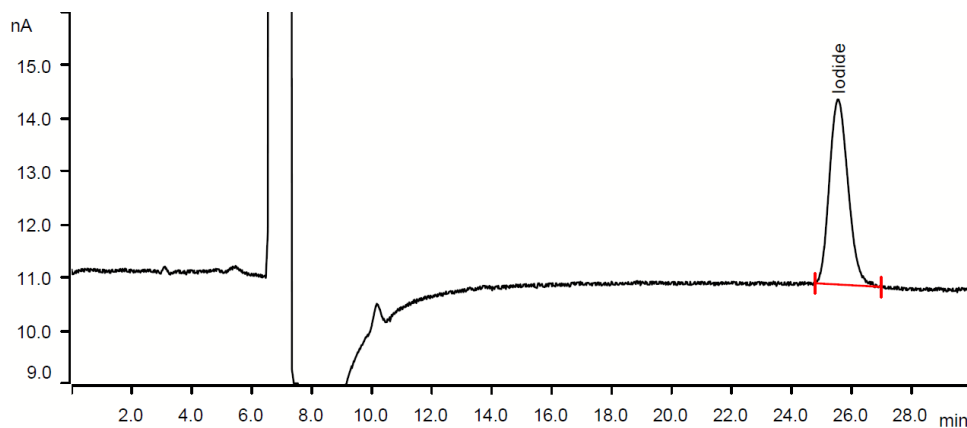

Amperometric signal (DC mode) of a straw mushroom table salt containing 21.2 mg/kg iodide. Iodate was not found in this sample.



# Dairy

## Lactose in low-lactose butter

### SUMMARY

Lactose-intolerance is a common digestive problem due to the deficiency of lactase. Lactase is the essential enzyme to split the disaccharide lactose into its monomers glucose and galactose, which can be further metabolized. Unsplit lactose causes serious problems in the intestine. Thus, lactose-intolerant people rely on lactose-free or low lactose food and beverage, which can be industrially produced from milk products by enzymatic hydrolysis of lactose.

An increasing global demand for these products has also raised the need for a thorough quality control in this sector. The remaining lactose content in the final product must be declared, e.g., when concentration exceeds 1000 mg/kg product [26].

This analytical method presented here is straightforward and accurately quantifies even lowest concentrations of lactose in milk and milk products.

### SAMPLES AND SAMPLE PREPARATION

- Low-lactose or lactose-free milk products (drinks, yogurt, cheese, butter, chocolate)
- 0.1–5 g sample extracted in water (total 50 g), then vortexed for 20 s

### MISP

- Inline Dialysis

### EXPERIMENTAL

Lactose in aqueous sample extracts was separated from other lactose derivatives on a Metrosep Carb 2 column using an alkaline eluent (400 mM NaOH) and pulsed amperometric detection (flexIPAD). Calibration for lactose ranged from 0.05 mg/L to 80 mg/L.

### RESULTS

Sample preparation with either Carrez precipitation or Inline Dialysis were compared, and

results differed less than 6%. The method LOD is determined via signal to noise with 0.4 mg lactose/100 g. The method was developed following a call from AOAC (Association of Official Agricultural Chemists) for a standardized method to determine low lactose contents (AOAC 2018.001).

### BENEFITS

- Separation of lactose from lactulose and allo-lactose, epilactose, galactosyllactose, avoids false positive results
- Determination of specific carbohydrates, in contrast to determining the total carbohydrate content
- No interferences from photometrically active components, as often observed with competing photometric methods
- Time and material saving easy sample preparation

Metrosep Carb 2 - 250/4.0	
Eluent	400 mmol/L NaOH
Flow	0.5 mL/min
Temp	35 °C
Injection	10 µL
Detection	flexIPAD

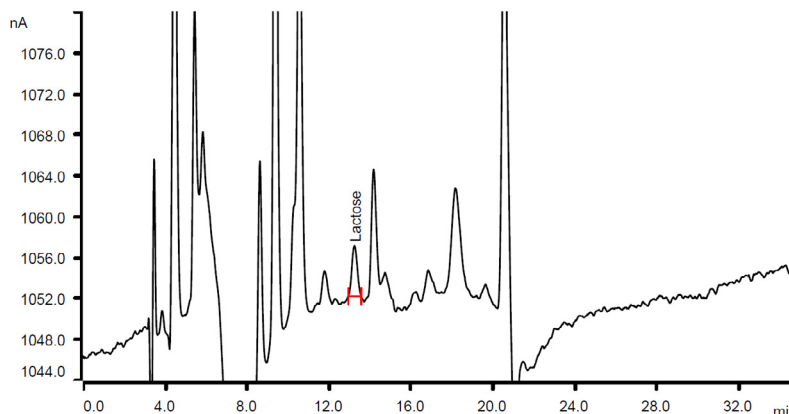

Amperometric signal of a low-lactose butter sample containing residual lactose (0.4 mg/100 g). Injection was performed after Inline Dialysis. Lactose was baseline separated from allo-lactose, epi-lactose, lactulose, and galactosyllactose.



# Dairy

## Carbohydrates in milk and milk products

### SUMMARY

Detailed and proper food labeling is an increasing concern of regulatory authorities and requested by many educated consumers. ISO 22184:2021 describes an analytical method for the quantification of six different mono- and disaccharides (galactose, glucose, fructose, sucrose, lactose and maltose) in milk and milk products with high performance anion exchange chromatography with pulsed amperometric detection (HPAEC-PAD) [27]. In contrast to classical standard methods describing the determination of a single carbohydrate in a certain food matrix, this method covers the six most important carbohydrates (galactose, glucose, fructose, sucrose, lactose, maltose) in different matrices with a single analysis.

This method determines the carbohydrate composition in milk and milk products in accordance with ISO 22184:2021.

### SAMPLES AND SAMPLE PREPARATION

- Milk powders, coffee creamer, condensed milk, cream cheese, processed cheese
- Extraction/Carrez precipitation as per ISO 22184:2021
- Dilution 10- or 50-fold

### MISP

- Inline Dilution (optional)

### EXPERIMENTAL

Samples were separated on a Metrosep Carb 2 column with a binary high-pressure gradient. After post-column addition of NaOH (0.3 mol/L) carbohydrates were detected with an optimized wave form in PAD mode. Calibration was from 0.52–260 mg/L for glucose, galactose, fructose, sucrose, lactose, and maltose. Arabinose was added to each sample and used as internal standard (end concentration 35 µg/L).

### RESULTS

Results were obtained from a successful participation in a multilaboratory test (MLT) for qualifying ISO 22184. The amperometric detector cell with thin-layer geometry proved most suitable for heavily loaded samples.

All analytes were precisely quantified in seven blind MLT duplicate samples. Further carbohydrates that might be present in any sample (fucose, melibiose, trehalose, lactulose, and isomaltulose) were well separated from the six carbohydrates of interest.

### BENEFITS

- Compliance with ISO 22184:2021
- One method is suitable for different milk products
- Minimal maintenance required to clean auxiliary and working electrode

Metrosep Carb 2 - 250/4.0	
Eluent	A: ultra pure water B: 0.4 mol NaOH + 2.0 mmol/L NaOAc
Flow	0.8 mL/min
Temp	25 °C
Injection	5 µL
Detection	PAD, 0.65 V

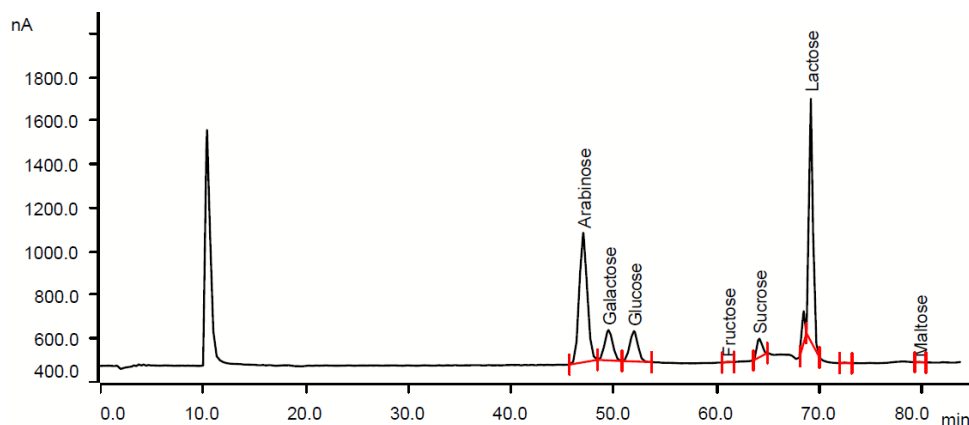

Amperometric signal (current) of a cream cheese sample, containing the major carbohydrates galactose (0.393 g/100g), glucose (0.384 g/100g), and lactose (2.316 g/100g). Fructose, sucrose and maltose were below the calibrated concentrations. Arabinose was used as internal standard.

# Dairy Iodide in milk

## SUMMARY

Iodine is an essential mineral to humans. The most important function of iodine in the human body is its role in the production of thyroid hormones. These hormones are especially important for brain and neural development in infancy. Major natural sources of iodine are seafood, eggs, and dairy products. Iodine deficiency and excess both cause adverse health effects. Thus, WHO gives recommendations for the total daily intake per age (e.g., 150 µg/day for adults) [28]. If iodine is added during food manufacturing, it must be listed on the Nutrition Facts label (FDA) [29].

The presented IC method excels with simple and time-saving sample preparation. Low Volume Inline Dialysis requires small sample volumes and provides for an automatic clean-up. Maintenance is minimized as the sample flow path as well as electrodes are cleaned automatically after each injection.

## SAMPLES AND SAMPLE PREPARATION

- Organic or standard whole milks, containing 3.5% fat
- 20-fold dilution in water (2.5 g milk per 50 g)

## MISP

- Inline Dialysis
- Inline Dilution (optional)

## EXPERIMENTAL

Dialyzed samples were separated on a Metrosep A Supp 17 column within 10 minutes. The amperometric detection of iodide was executed with direct current within a range of 2–50 µg/L. Electrodes were automatically cleaned after each injection («CV treatment», patent filed) with flexIPAD cleaning. The sample path was kept clean by rinsing it with methanol (10% v/v). The solution was automatically prepared from water and

methanol with a Metrohm Dosino.

## RESULTS

The concentrations of free iodide ranged from 23.4 µg/L to 140.8 µg/L. Spiking tests showed recoveries of 92–110% for iodide within the calibrated range.

## BENEFITS

- Straightforward sample preparation without Carrez precipitation
- Efficient clean up of samples from fats, proteins, and other higher molecular weight compounds with Low Volume Inline Dialysis
- Precise determination of iodide in milk products in the µg/L range
- Less maintenance of electrodes due to automatic cleaning cycles with «CV treatment» (patent filed)

### Metrosep A Supp 17 - 150/4.0

Eluent	60 mmol NaOH + 20 mmol/L NaOAC
Flow	0.6 mL/min
Temp	35 °C
Injection	80 µL
Detection	DC, 0.05 V

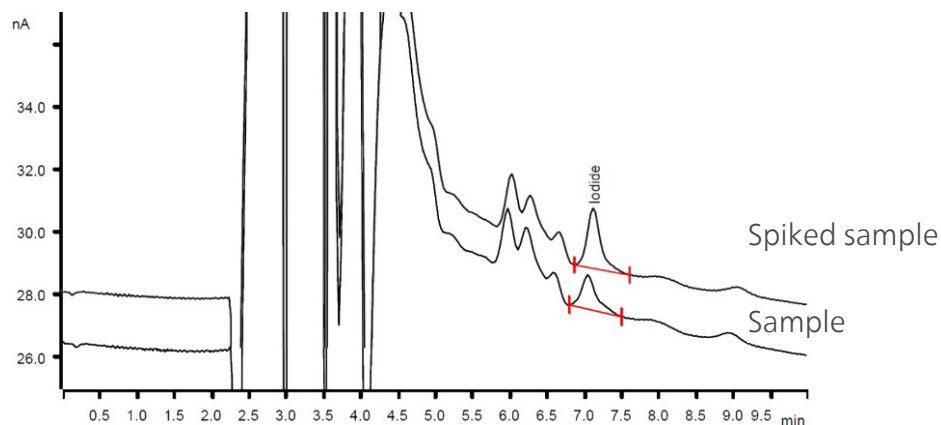

Overlay of a chromatogram from a milk sample (20-fold dilution), containing 148 µg/L iodide (lower chromatogram), and from a milk sample spiked with 100 µg/L iodide (upper chromatogram). The recovery was 102%.



# Dairy

## Nitrite and nitrate in milk products

### SUMMARY

In higher concentrations, nitrite can react to form carcinogenic nitrosamines or influence the oxygen transport in blood, causing methemoglobinemia. Sources for nitrate and nitrite in milk are milk powder preservatives, contaminated animal feed, or fertilizers. Currently, legal limits are not defined for nitrite and nitrate in milk. However, the Expert Committee from WHO (World Health Organization) and FAO (Food and Agriculture Organization) recommends an acceptable daily intake per kg body weight of 0.07 mg for nitrite and 3.7 mg for nitrate [30].

IC with Metrohm Inline Dialysis and suppressed conductivity detection offers a straightforward analytical technique to analyze the content of nitrate and nitrite in various milk products. Other anions like chloride, phosphate, sulfate, or citrate can be quantified in the same run.

### SAMPLES AND SAMPLE PREPARATION

- Milk powder, whey, and cheese
- 1 g sample in  $\approx 60$  mL water is heated at 45 °C for 20 min. Afterwards, the volume is adjusted to 100 mL

### MISP

- Inline Dialysis

### EXPERIMENTAL

After Inline Dialysis, analytes are separated on a Metrosep A Supp 5 column using a Dose-in gradient (A: 2.0 mmol  $\text{Na}_2\text{CO}_3$  + 2.0 mmol/L  $\text{NaHCO}_3$  + 2.5% acetone; B: 20.0 mmol  $\text{Na}_2\text{CO}_3$  + 2.0 mmol/L  $\text{NaHCO}_3$  + 2.5% acetone). Calibration ranged from 0.05 to 25 mg/L for all analytes.

### RESULTS

Milk samples were directly injected, whereas the whey and

cheese samples were further diluted (2–100-fold). Spiking tests with nitrate and nitrite (0.1 mg/L each) showed recoveries of 90–120%. Milk samples contained  $<0.5$  mg nitrite and between 0.5–5 mg nitrate per 100 g. Optionally, a UV/VIS Detector can be placed in series after the conductivity detector for more sensitive detection of nitrite, nitrate, and bromide. Especially, as chloride is not UV active, this is preferable for samples with high chloride contents in the matrix.

### BENEFITS

- Straightforward sample preparation, no need for sample preparation cartridges
- Less consumables and less time due to Inline Dialysis
- Dose-in gradient to accelerate late-eluting peaks
- Robust and easy-to-handle method for anions in milk

Metrosep A Supp 5 - 250/4.0	
Eluent	Dose-in gradient ( $\text{Na}_2\text{CO}_3$ + $\text{NaHCO}_3$ + acetone)
Flow	0.7 mL/min
Temp	40 °C
Injection	20 $\mu\text{L}$
Detection	Conductivity

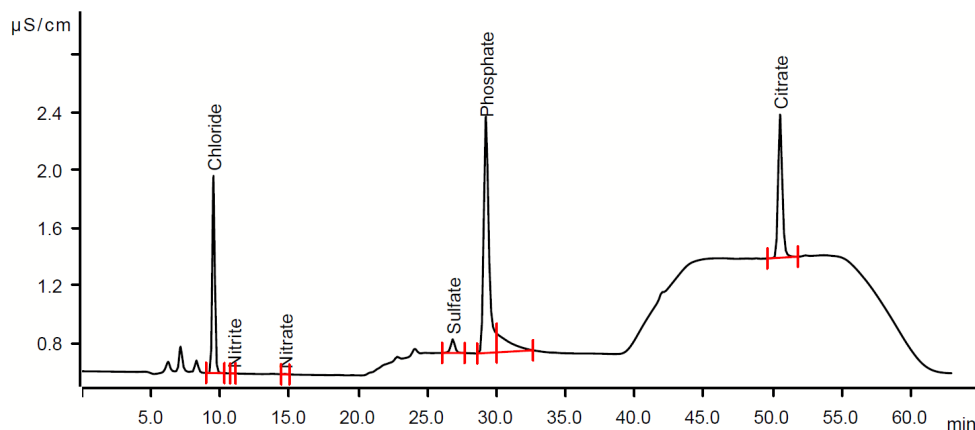

Suppressed conductivity signal for the analysis of a milk powder sample, containing chloride (11.5 mg/100 g), phosphate (104.0 mg/100 g), and citrate (63.3 mg/100 g) as major inorganic anions, as well as nitrate (0.2 mg/100 g) and sulfate (2.6 mg/100 g). Nitrite was less than 0.5 mg/100 g.





# Dairy

## Choline in infant formula milk powder

### SUMMARY

Choline is a water-soluble micronutrient, essential for humans and many other mammals. Choline phospholipids are necessary components in the cell membranes for the transmission of nerve signals to the brain, i.e., for mental fitness and physical performance.

Due to its nutritional importance, choline is a common supplement in various infant formulas. AOAC and GB have proposed chromatographic methods for its quantification [31, 32]. Sample preparation involves acidic hydrolysis to release bound choline from e.g., lecithin and sphingomyelin and enables the detection of total choline.

In line with AOAC SMPR 2012.013, the IC method shows the determination of choline after isocratic elution by conductivity detection. Even with non-suppressed conductivity, the detection of choline showed to be sensitive, robust and easy.

### SAMPLES AND SAMPLE PREPARATION

- Infant-, children-, and pregnant/lactating women formula milk powder
- Acidic hydrolysis of 5 g sample with 30 mL HCl (1 mol/L) at 70 °C for 3 hrs.
- Centrifugation (10,000 rpm), filtration (0.22 µm), pH adjustment to 2–7 (50% NaOH), and dilution

### MISP

- Inline Dilution (optional)
- Inline Ultrafiltration (optional)

### EXPERIMENTAL

Choline was separated as cation on the high-capacity Metrosep C 6 column using isocratic conditions. It elutes after 13 minutes and was detected with direct conductivity. For quality checks and validation,

analysis of standard material NIST SRM 1849a is recommended.

### RESULTS

Nine samples of seven brands of milk powder were analyzed. They complied with the requirements for 50–400 mg choline per 100 g. Repeatability of 200 samples showed RSDs <3% RSD. LOQ was 1.02 mg/100g. Within a method verification of AOAC SMPR 2012.013, five independent laboratories achieved comparable results (<10% RSD between results).

### BENEFITS

- Compliance with method AOAC SMPR 2012.013
- Inline sample preparation possible
- Robust and easy-to-handle setup with isocratic elution and non-suppressed conductivity

Metrosep C 6 - 150/4.0	
Eluent	6.0 mmol/L HNO <sub>3</sub> + 5% acetone
Flow	0.9 mL/min
Temp	30 °C
Injection	20 µL
Detection	Conductivity

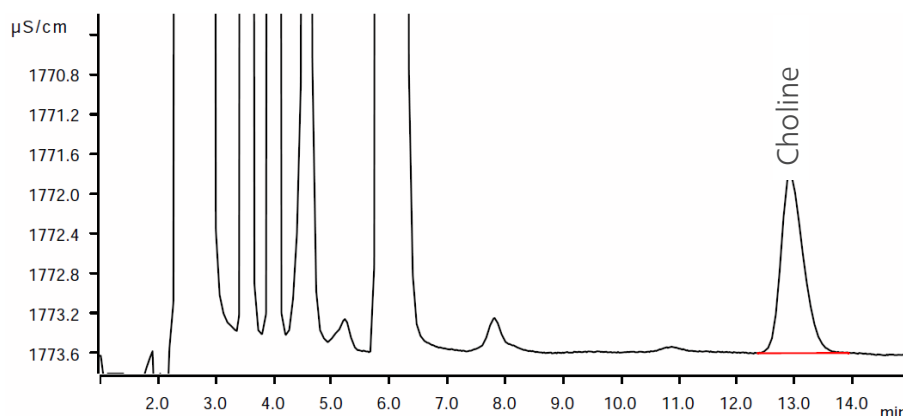

Non-suppressed conductivity signal of a milk powder sample, containing 20 mg/L choline. Sample preparation and analysis was performed according to requirements for AOAC 2012.013.



# Further applications in brief

Analytes	Matrix	Technique	Advantages
Anions, e.g., chloride, nitrate, sulfate	Fruit juice concentrates	IC with Metrohm Inline Dilution Technique (MIDT) and Inline Ultrafiltration (UF)	Optimized settings, e.g., adjustment of the sample needle depth in a zone without pulp to avoid filter clogging.
Cations, e.g., ammonium, manganese, sodium, potassium	Mineral water	IC with Metrohm intelligent Preconcentration Technique (MiPCT)	Non-suppressed conductivity is a robust and easy technique, compared to suppressed cation analysis. MiPCT guarantees low detection limits and. The system is automatically calibrated with one standard solution.
Food preservatives, e.g., sorbate and benzoate	Flavored bottled water	IC with conductivity detection after inverse suppression	Solvent extractions or sample derivatization is not necessary, in contrast to many GC methods. Counter cations can be determined with a second analysis channel.
Chloride, nitrite, nitrate, phosphate, sulfate, citrate	Whey, cheese, milk powder	IC with Inline Dialysis as automatic sample preparation	Gradient for optimal separation of all components in a single analysis.
Melamine	Milk powder	IC with Inline Dialysis and UV/VIS detection	The technique is specific for melamine, in contrast to the non-specific nitrogen determination according to Kjeldahl. Illegal melamine addition is recognized. Complex GC/MS or LC/MS methods are not necessary.
Fructans	Infant formula	IC with a flow gradient and pulsed amperometric detection (PAD)	The method works without any additional sample derivatization. Thanks to the flow-gradient, only one eluent and one high-pressure pump are necessary. The method was validated by successful participation in the multilaboratory trial for acceptance of ISO 22579/AOAC 2014.14).
Carbohydrates, e.g., glucose, fructose, sucrose	Soft drinks, e.g. cola	IC with isocratic elution and PAD	Simple and robust system setup.

## Further applications in brief (cont.)

Analytes	Matrix	Technique	Advantages
Cations, e.g., lithium, sodium, ammonium, potassium, magnesium, calcium	Skimmed milk	IC with Inline Dialysis and non-suppressed conductivity detection	Fully automated Metrohm Inline Dialysis reduces manual sample preparation steps to a minimum.
Lactate and cations, e.g., sodium, potassium, magnesium, calcium	Lactoserum powder	IC with non-suppressed conductivity detection	Separation and quantification of (anionic) lactate and cations in a single run on the same analysis channel is less complex than AAS or ICP/MS analysis.
Thiocyanate	Formulated milk powder and liquid milk	IC with sequential suppressed and conductivity detection	The Metrohm Suppressor Module (MSM) shows outstanding performance, even when organic solvents are present in the eluent (here: 5% acetone). The setup guarantees stable results and robust long-time performance.
Stabilizers and flavor enhancers, e.g., polyphosphates (pyrophosphate, trimetaphosphate, tripolyphosphate)	Shrimp, seafood	IC with Inline Ultrafiltration and Metrohm intelligent partial loop technique (MiPT)	This simple and robust method determines the distribution of polyphosphate chain lengths, which gives valuable information about sequestering and dispersing properties, whereas end-group titration methods only provide an average for polyphosphate chain lengths.  Clogging of the analytical system is excluded due to Metrohm Inline Ultrafiltration.
Acrylamide	Potato chips	IC with mass spectrometric detection	Coupling an IC with a mass detector guarantees selective and sensitive detection of the analyte of interest. Automated calibration is possible.
Sulfite	Foodstuffs, e.g., chickpeas, mustard, cherries, capers, canned garlic, chili pepper, red wine	IC with amperometric detection (DC mode) and automated electrode cleaning	This fast and accurate method is selective for sulfite and replaces labor-intensive solution extraction as sample preparation.

# IC compliance with norms and standards

*Standards are the basis of national laws which give detailed instructions on the analytical method requirements [33].*



Analytes	Matrix	Norm or standard
Bromate	Water	ISO 15061: 2001 Water quality — Determination of dissolved bromate — Method by liquid chromatography of ions
Bromate	Water	ISO 11206: 2011 Water quality — Determination of dissolved bromate — Method using ion chromatography (IC) and post column reaction (PCR)
Bromide, bromate, chloride, chlorite, chlorate, fluoride, nitrate, nitrite, phosphate, sulfate, dichloroacetate	Water	EPA Method 300.1 Determination of inorganic anions in drinking water by ion chromatography
Bromide, chloride, fluoride, nitrate, nitrite, phosphate and sulfate	Water	ISO 10304-1: 2007 Water quality — Determination of dissolved anions by liquid chromatography of ions — Part 1
Chlorate, chloride, chlorite	Water	ISO 10304-4: 1997 Water quality — Determination of dissolved anions by liquid chromatography of ions — Part 4
Choline	Infant Formula, Adult Nutritional	AOAC Official Method 2012.20 Choline in infant formula and adult nutritional ion chromatography and suppressed conductivity
Chromate, iodide, sulfite, thiocyanate, thiosulfate	Water	ISO 10304-3: 1997 Water quality — Determination of dissolved anions by liquid chromatography of ions — Part 3
Chromium	Water	AOAC Official Method 993.23 Dissolved hexavalent chromium in water
Chromium	Water	DIN 38405-52 German standard methods for the examination of water, wastewater and sludge – Anions (group D) – Part 52: Photometric Determination of dissolved chromium(VI) in water (D 52)
Fluoride, chloride, nitrite, nitrate, phosphate, sulfate	Water	AOAC 993.30 Inorganic anions in water
Fructans	Foodstuff, e.g., cheese spread, chocolate, wine gum, drink mix, biscuits	AOAC Official Method 997.08 Fructans in food products
Fructans, glucose, fructose	Infant Formula, Adult Nutritional	AOAC Official Method 2016.14 Fructans in infant formula and adult nutritional [34]
Fructans, glucose, fructose	Infant Formula, Adult Nutritional	ISO 22579: Infant formula and adult nutritional — Determination of fructans — High performance anion exchange chromatography with pulsed amperometric detection (HPAEC-PAD) after enzymatic treatment [34]
Galactose, glucose, fructose, sucrose, lactose, maltose	Milk and milk products	ISO 22184: 2021 [IDF 244] Milk and milk products — Determination of the sugar contents — High performance anion exchange chromatography with pulsed amperometric detection method (HPAEC-PAD) [27]
Glucose, fructose	Cane Sugar	AOAC Official Method 2000.17 Determination of trace glucose and fructose in raw cane sugar
Glucose, fructose	Raw sugar or processed sugar	ICUMSA Method GS1/2/3-4 (1998) The Determination of glucose and fructose in raw and white sugars using high performance anion-exchange chromatography (HPAEC) – official

## IC compliance with norms and standards (cont.)

*Metrohm ion analysis also offers equipment for titration and voltammetry, and pH value measurement to fulfill standards for the analysis of beverages.*

Analytes	Matrix	Norm or standard
Glucose, fructose, sucrose	Cane and beet final molasses	AOAC Official Method 996.04 Sugars in cane and beet final molasses
Glucose, fructose, sucrose	Cane juices, cane syrups, cane and beet molasses	ICUMSA Method GS7/8/4-24 (2011) The determination of glucose, fructose and sucrose in cane juices, syrups and molasses and of sucrose in beet molasses by high performance ion chromatography – official method
Iodide	Pasteurized liquid milk, skim milk powder	AOAC Official Method 992.22: Iodine (as iodide) in pasteurized liquid milk and skim milk powder
Lactose	Lactose-free and low-lactose milk products	AOAC SMPR 2018.009 Standard Method Performance Requirements (SMPR®) for lactose in low-lactose or lactose-free milk, milk products and products containing dairy ingredients
Lithium, sodium, ammonium, potassium, manganese, calcium, magnesium, strontium, barium	Water	DIN EN ISO 14911 - 1999: Water quality - Determination of dissolved Li, Na, ammonium, K, Mn(II), Ca, Mg, Sr and Ba using ion chromatography
Mannitol, arabinose, galactose, glucose, mannose, fructose, ribose, xylose, sucrose, fucose	Instant coffee	AOAC Official Method 995.13 Carbohydrates in soluble (instant) coffee - anion-exchange chromatographic method with pulsed amperometric detection
Mannitol, arabinose, glucose, galactose, sucrose, xylose, mannose, fructose	Instant coffee	DIN 10780 (2003)/ISO 11292: 1995 Instant coffee - Determination of free and total carbohydrate contents - method using high-performance anion-exchange chromatography
Mannitol, Glucose, Fructose, Sucrose	Beet juice and cane juice	ICUMSA Method GS8-26 (2013) The determination of mannitol, glucose, fructose, sucrose and raffinose in beet brei and beet juices by HPAEC-PAD
Myo-Inositol	Infant and pediatric formula, adult nutritionals	AOAC Official Method 2011.18 Myo-inositol (free and bound as phosphatidylinositol) in infant and pediatric formula and adult nutritionals
Myo-Inositol	Infant formula, adult nutritionals	ISO 20637: 2015 Infant formula and adult nutritionals – Determination of myoinositol by liquid chromatography and pulsed amperometry
Perchlorate	Water	ISO 19340: 2017 Water quality – Determination of dissolved perchlorate – Method using ion chromatography (IC)
Polydextrose	Various foodstuff	AOAC official Method 2000.11 Polydextrose in food
Propionic acid	Cheese	ISO/TS 19046-2: 2017 Cheese – Determination of propionic acid level by chromatography – Part 2: Method by ion exchange chromatography
Raffinose	Beet molasses and beet sugar	ICUMSA Method GS4/8-19 (2005) The Determination of raffinose by high performance anion-exchange chromatography (HPAEC) – in impure beet sugar products – official
Sulfite	Brown Sugar	ICUMSA Method GS 3-52 (2019) Sulfite as SO <sub>2</sub> in brown sugars by the optimized Monier-Williams and HPIC single method
Trans-Galactooligosaccharides (TGOS)	Foodstuff, e.g., custard, cereal, yogurt drink, biscuits, syrup	AOAC Official Method 2001.02: Determination of trans-galactooligosaccharides (TGOS) in selected food products

# Time and money savers – automation and Metrohm Inline Sample Preparation (MISP)

*Food analytics is a wide and comprehensive area. Samples are very complex, as are their processing and analysis.*

*Automation and MISP help to save valuable laboratory time during processing, while increasing precision and robustness of results.*

Real-world samples not only contain the target components, but also matrix components which can be aggressive and affect and degrade the system, leading to clogging or precipitation in the system. Therefore, proper sample preparation is essential for reliable and accurate analysis and for protection of the column and system. Metrohm offers a variety of automated Inline Sample Preparation Techniques (MISP), are fully integrated into the system sparing the user from tedious manual work and saving a substantial amount of time.

## INLINE ULTRAFILTRATION

... is a fast and cost-effective alternative to manual filtration with cartridges and syringes. The frequent replacement of filters after each single injection or manual filtration make this process costly, time consuming and wasteful.

Metrohm Inline Ultrafiltration is a fully automated solution, using membrane filters with a pore size of 0.2 µm. They can be applied to multiple samples, standards, and blanks with a carryover of < 0.1%.

**Applications:** Diluted fruit and vegetable juices, drinking water, extracts, digestion solutions, and samples slightly or moderately contaminated with particles, algae, or bacteria.

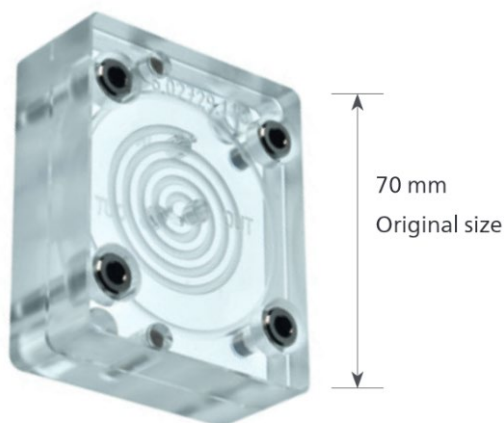

**Metrohm Ultrafiltration cell 2:** The two parts of the Ultrafiltration cell are separated by a filter membrane. On one side, the sample is carried through the cell at a constant flow rate. On the other side, some of the sample is drawn off through the membrane and transported to the injection valve. The formation of filter cake is prevented by continuous flushing of particles out of the cell at a high flow rate.

## INLINE DIALYSIS

... is the answer to complex sample matrices. This technique separates not only particles from their analytes, but also colloids, oil components, and large molecules. Samples containing proteins can be injected directly after Inline Dialysis, which saves time-consuming manual steps such as the removal of proteins with Carrez precipitation.

**Applications:** Concentrated fruit and vegetable juices, dairy products and other protein-containing samples, e.g., flour and honey, emulsions, dispersions, oil-containing samples, fermentation samples, and samples heavily contaminated with particles, algae, or bacteria.

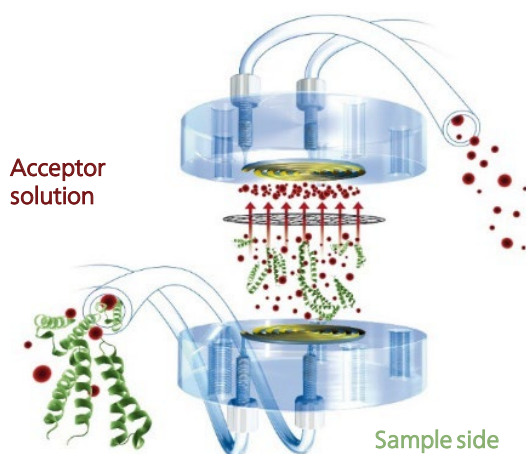

**Stopped-Flow Dialysis:** Sample is continuously pumped on the sample side. After rinsing, the acceptor stream is stopped. Due to a concentration gradient, the ions pass through the membrane until an equilibrium between acceptor and original solution is reached. Afterwards, the acceptor solution is injected directly into the IC.

# Time and money savers – automation and Metrohm Inline Sample Preparation (MISP)

*Automation and logical features support reliability and accuracy of the results by omitting manual error-prone steps.*

Dilution is a routine procedure in sample analysis. It is still often performed manually and therefore is error-prone and time-consuming. The Metrohm Inline Dilution Technique (MIDT) or Metrohm intelligent Partial Loop Technique (MiPT) offer a precise, accurate, and fully automated alternative to manual dilution as well as the solution for automated calibration of the system over several orders of magnitude regarding concentrations of target analytes. The software MagIC Net can handle logical decision, a way to further optimize sample processing.

## MIDT

... provides automatic dilution of the sample depending on either a predefined or an automatically calculated optimum dilution factor (Logical Inline Dilution). Standards can also be diluted. The system dilutes the standard with different dilution factors and thus carries out multi-point calibration. Sample concentrations in the range of 1:10,000 can be analyzed reliably with a single automated calibration. MIDT can be combined with Inline Ultrafiltration and Inline Dialysis.

## LOGICAL INLINE DILUTION

A further advantage of Metrohm IC is Logical Inline Dilution. The sample just needs to be placed on the autosampler and the analysis is started.

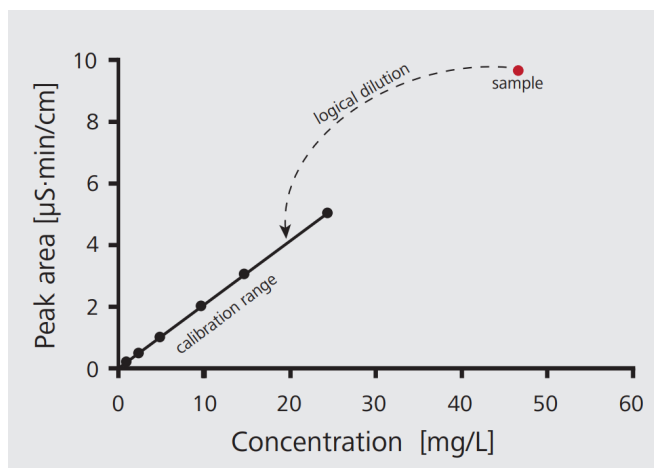

**Logical dilution:** If the sample concentration is outside the calibration range, it is diluted with the optimum dilution factor and analyzed again. Hence, your results are always within the calibration range.

The system automatically calculates the optimum dilution factor and analyzes the sample. Thus, your results are always reliable, because they are always within the calibration range.

## MiPT

... automatically adjusts the injection volume to the concentration of the sample. This technique ensures that the results are always within the calibration range. Injection volumes of anything between 2 and 200 µL are possible. The optimum injection volume is automatically calculated, making it possible to cover a very wide range of sample concentrations. Furthermore, this technique is almost free of any carryover (<0.001%), enabling sequential analysis in the mg/L and µg/L range.

MiPT is characterized by outstanding linearity over the entire volume range. For this reason, this technique can also be used for automatic calibrations using a single multi-component standard.

Learn more about Metrohm's automation and sample preparation:

- [Monograph: Sample Preparation Techniques for Ion Chromatography](#)
- [Brochure: Metrohm Inline Sample Preparation – IC analyses as simple as possible](#)
- [Automation in ion chromatography – Save time and money through fully automated sample preparation and analysis](#)

# Learn more about IC IC in brief

From routine IC analysis to research and development, and from stand-alone analyzers to fully automated systems: Metrohm offers solutions for automated IC including inline sample preparation and separation columns for anions, cations, and carbohydrates in almost any sample matrix. Data integrity is guaranteed.

[Monograph Ion Chromatography](#)

[Monograph – Practical Ion Chromatography – An Introduction](#)

[Monograph: Sample Preparation Techniques for Ion Chromatography](#)



A 3-year instrument warranty and 10-year warranty on our anion suppressor say it all about the robust Swiss quality of our high-pressure ion chromatographs (HPIC).

[Brochure: Suppression in anion chromatography – More sensitive analysis of anions and organic acids](#)

[STREAM – the green way of suppression](#)

Ion analysis with Metrohm:

- High-performance IC systems
- Complete automation for high sample throughput
- Highest sensitivity for lowest detection limits
- Compliant with GLP and the FDA regulations
- Wide range of detection options including conductivity, UV/VIS, amperometry, ...





## Detection techniques

# Conductivity

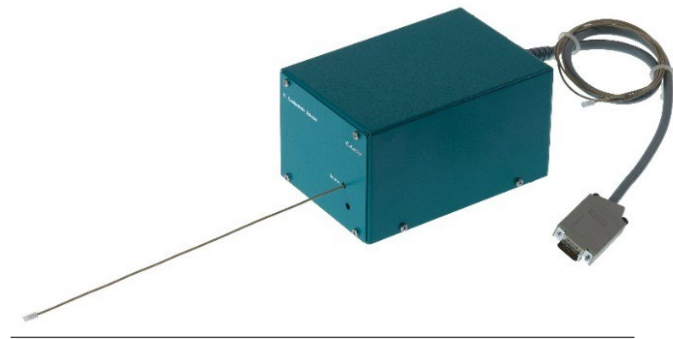

IC Conductivity Detector

Almost every ionic compound gives a signal with conductivity detection. A conductivity detector is a universal detector for multi-ion analysis in food and beverage samples. It is the detector of choice when using IC as separation technique. The intelligent high-performance conductivity detector from Metrohm excels with robustness and a very low baseline noise of less than 0.2 nS/cm under standard operation conditions.

- Low maintenance costs and long lifetime
- Robust Swiss quality
- Highest sensitivity for lowest detection limits
- For routine analyses and research applications in the ng/L- to %-range

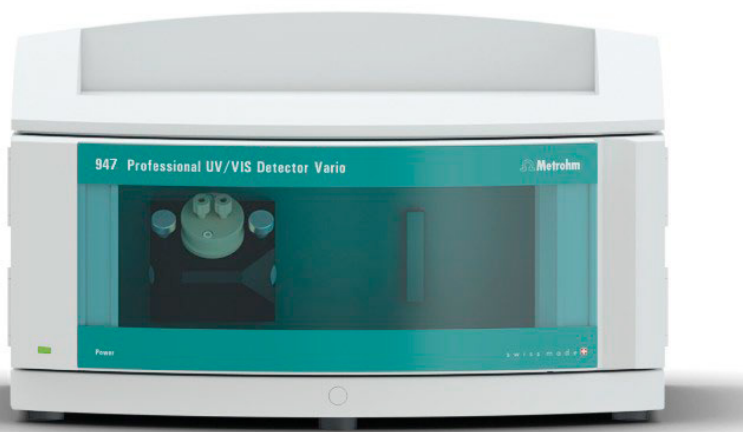

947 Professional UV/VIS Detector

## Detection techniques

# UV/VIS detection

UV/VIS detection enables reliable and accurate quantification of substances that absorb light in the ultraviolet or visible range. IC applications with UV/VIS detection from the food and beverage sector often involve samples with salty matrices. Since chloride from salt does not cause major interferences with UV/VIS detection it is suitable for e.g., determination of nitrate and nitrite in sausages.

With additional pre-column or post-column reaction (PCR) many additional substances can be transformed into UV-active or VIS-active molecules, which makes these substances also detectable.

The intelligent multi-wavelength detector from Metrohm has several wavelengths that can be freely selected. A diode array is used for detection.

# Detection techniques

## Amperometry



Wall-Jet Cell with electrodes for amperometric detection

IC equipped with an amperometric detector opens the door to analyze almost any ions that can be oxidized or reduced, e.g., carbohydrates, glycosides, fructans, alcohols, amines, amino acids, phenols, organosulfur compounds, cyanide, sulfide, ascorbic acid, vitamins and many more.

The analysis of carbohydrates (sugars) is of particular interest because not only is the total sugar content determined, but the distribution and amount of distinct carbohydrates can also be analyzed. The amperometric detector from Metrohm has a three-electrode configuration that ensures excellent signal-to-noise levels. Numerous electrodes and accessories are available to fit for every application need.

Amperometric detection is much more sensitive than refractive index detection, which allows the injection of highly diluted samples in order to keep the system clean and safeguard uninterrupted operation of the system for a long period of time. The system has self-monitoring functionalities for full traceability and to minimize the risk of operating errors.



945 Professional Detector Vario – Conductivity & Amperometry

Cardiovascular diseases, obesity, and diabetes are the major causes of death in our society. They are connected to our nutritional practice. WHO recommends restricting the intake of free sugars (monosaccharides and disaccharides) to less than 10% of total energy intake in order to reduce the risk of noncommunicable diseases (NCD), with a particular focus on the prevention and control of unhealthy weight gain and tooth decay [35]. Even in Switzerland, daily consumption of free sugars per person per day is about five times higher than the recommended intake [36].

Manufacturing of healthy products relies on dedicated analysis of foodstuffs for quality control during the production process. Detailed food labeling can help to increase awareness and enable consumers to make healthy decisions. Metrohm IC offers analytical solutions to tackle these challenges in the food and beverage industries.

## References

- [1] FAO (Food and Agriculture Organization of the United Nations ) (2005), Codex general standard for fruit juices and nectars (CODEX STAN 247-2005), [www.fao.org/input/download/standards/CXS\\_247e](http://www.fao.org/input/download/standards/CXS_247e) (accessed Apr 1, 2021).
- [2] Nakakuki, T. (2002), Present status and future of functional oligosaccharide development in Japan, *Pure and Applied Chemistry*. 74 (7): 1245–1251, doi:10.1351/pac200274071245. S2CID 35500606 (accessed Apr 1, 2021).
- [3] EFSA (European Food Safety Authority ), Aspartame, [www.efsa.europa.eu/en/topics/topic/aspartame](http://www.efsa.europa.eu/en/topics/topic/aspartame) (accessed Apr 1, 2021).
- [4] WHO (World Health Organization) Technical Report Series 837 (Geneva 1993), Evaluation of certain food additives and contaminants, WHO\_TRS\_837.pdf; (accessed Apr 1, 2021).
- [5] Morrison, O. (2020), Food standards agencies rule out aspartame bans as scientists warn of ‘adverse effects’ on consumers, [foodnavigator.com https://www.foodnavigator.com/Article/2020/11/13/Food-standards-agencies-rule-out-aspartame-bans-as-scientists-warn-of-adverse-effect-on-consumers](https://www.foodnavigator.com/Article/2020/11/13/Food-standards-agencies-rule-out-aspartame-bans-as-scientists-warn-of-adverse-effect-on-consumers) (accessed Apr 1, 2021).
- [6] Bernadene, A. et al. (2017), Critical review of the current literature on the safety of sucralose, *Food and Chemical Toxicology* 106 (A), 324-355.
- [7] Friedman, M. A. (1998), Lead Deputy Commissioner for the FDA, Food Additives Permitted for Direct Addition to Food for Human Consumption; Sucralose Federal Register: 21 CFR Part 172, Docket No. 87F-0086.
- [8] US FDA (US Food and Drug Administration) (2006), Food labeling: health claims; dietary noncariogenic carbohydrate sweeteners and dental caries, *Federal Register*. 71 (60): 15559–64. PMID 16572525.
- [9] US FDA (US Food and Drug Administration) (2019), Detention without physical examination of Stevia leaves, crude extracts of Stevia leaves and foods containing Stevia leaves and/or Stevia extracts, Import Alert 45-06.
- [10] WHO (World Health Organization) (2005), Bromate in Drinking-water, Background document for development of WHO Guidelines for Drinking-water Quality, WHO/SDE/WSH/05.08/78 [www.who.int/water\\_sanitation\\_health/dwq/chemicals/bromate260505.pdf](http://www.who.int/water_sanitation_health/dwq/chemicals/bromate260505.pdf) (accessed Apr 1, 2021).
- [11] WHO (World Health Organization) (2005), Glyphosate and AMPA in Drinking-water, Background document for development of WHO Guidelines for Drinking-water Quality, WHO/SDE/WSH/03.04/97, IARC Monographs Vol. 112: evaluation of five organophosphate insecticides and herbicides <https://www.iarc.who.int/wp-content/uploads/2018/07/MonographVolume112-1.pdf> (accessed Apr 1, 2021).
- [12] US EPA (US Environmental Protection Agency) (2019), EPA Takes Next Step in Review Process for Herbicide Glyphosate, Reaffirms No Risk to Public Health, News Releases from Headquarters on Chemical Safety and Pollution Prevention <https://www.epa.gov/newsreleases/epa-takes-next-step-review-process-herbicide-glyphosate-reaffirms-no-risk-public-health> (accessed Apr 1, 2021).
- [13] US EPA (US Environmental Protection Agency) (2009), National Primary Drinking Water Regulations, EPA 816-F-09-004 <https://www.epa.gov/ground-water-and-drinking-water/national-primary-drinking-water-regulations> (accessed Apr 1, 2021).

## References (cont.)

- [14] US EPA (US Environmental Protection Agency) (1995) National primary drinking water regulations, glyphosate, EPA 811-F-95-003q-T.
- [15] Anvisa (Brazilian Health Regulatory Agency) (2021), Glifosato, [www.gov.br/anvisa/pt-br/setorregulado/regularizacao/agrotoxicos/monografias/monografias-autorizadas/g-h-i/4378json-file-1/view](http://www.gov.br/anvisa/pt-br/setorregulado/regularizacao/agrotoxicos/monografias/monografias-autorizadas/g-h-i/4378json-file-1/view) (accessed Apr 1, 2021).
- [16] Waterhouse et al. (2016), *Understanding Wine Chemistry*, John Wiley & Sons, UK, ISBN 1118627806.
- [17] OIV (International Organization of Vine and Wine) (2021), OIV, France, ISBN 978-2-85038-030-3.
- [18] Konakovsky, V. et al. (2010) Levels of histamine and other biogenic amines in high quality red wines, *Food Additives and Contaminants - Part A Chemistry, Analysis, Control, Exposure and Risk Assessment* 28(4):408-16
- [19] Wang, P. et al. (2002), *Nitric Oxide Donors: Chemical Activities and Biological Applications*, *Chemical Reviews* 102 (4): 1091–1134.
- [20] EFSA (European Food Safety Authority) (2017), Re-evaluation of potassium nitrite (E 249) and sodium nitrite (E 250) as food additives, *EFSA Journal* 15(6):4786.
- [21] EFSA (European Food Safety Authority) (2019), Re-evaluation of phosphoric acid–phosphates – di-, tri- and polyphosphates (E 338–341, E 343, E 450–452) as food additives and the safety of proposed extension of use, doi: 10.2903/j.efsa.2019.5674 (accessed Apr 1, 2021).
- [22] D'Amore, T. et al. (2020) Sulfites in meat: Occurrence, activity, toxicity, regulation, and detection. A comprehensive review, *Food science and food safety* 19 (5), 2701-2720.
- [23] Metrohm AG. Simplified sulfite determination in foods and beverages using ion chromatography, Metrohm AG: Herisau, Switzerland, 2021. WP-065EN.
- [24] Lanciki, A., Espinosa, M. (2020) A Simplified Method to Determine Total sulfite Content in Food and Beverages via Ion Chromatography, *LC/GC The Column* 16 (2), 12-16.
- [25] AQSIQ (State general administration of the Peoples Republic of China for quality supervision and inspection and quarantine) Determination of iodide content in foods for export – Ion chromatography, GB China National Standards SN/T 3727-2013.
- [26] Association of official analytical collaboration (AOAC) (2018): AOAC SMPR® 2018.009, Standard Method Performance Requirements (SMPRs) for Lactose in Low-Lactose or Lactose-Free Milk, Milk Products, and Products Containing Dairy Ingredients, AOAC International, Rockville, MD, USA.
- [27] Brunt, K. et al. (2020), Results Multi-Laboratory Trial ISO/CD 22184 – IDF/WD 244: Milk and milk products – Determination of the sugar contents – High performance anion exchange chromatography method with pulsed amperometric detection (HPAEC-PAD), *Journal of AOAC International*, qsa092.
- [28] WHO (World Health Organization) (1996), Recommended iodine levels in salt and guidelines for monitoring their adequacy and effectiveness, WHO/NUT/96.13.
- [29] Trumbo, P. (2016), FDA regulations regarding iodine addition to foods and labeling of foods containing added iodine, *American Journal of Clinical Nutrition* 104(Suppl 3), 864S–867S.
- [30] WHO (World Health Organization) (2011), Nitrate and nitrite in drinking-water, Background document for development of WHO Guidelines for Drinking-water Quality, WHO/SDE/WSH/07.01/16/Rev/1 [https://www.who.int/water\\_sanitation\\_health/dwq/chemicals/nitratenitrite2ndadd.pdf](https://www.who.int/water_sanitation_health/dwq/chemicals/nitratenitrite2ndadd.pdf) (accessed Apr 1, 2021).

## References (cont.)

- [31] Chinese standard (2019), National food safety standard for determination of choline in infant foods and dairy products, GB China National Standards 5413.20-2013.
- [32] AOAC Official Method 2012.20 (2012), Choline in Infant Formula and Adult Nutritionals Ion Chromatography and Suppressed Conductivity First Action.
- [33] Lebensmittel- und Futtermittelgesetzbuch – LFGB (2005), Bundesministeriums der Justiz und für Verbraucherschutz, Bundesamts für Justiz, [www.gesetze-im-internet.de/lfgb/LFGB.pdf](http://www.gesetze-im-internet.de/lfgb/LFGB.pdf) (accessed Apr 1, 2021).
- [34] Spichtig, V. et al. (2020) ; Determination of Fructans in Infant Formula and Adult/Pediatric Nutritional Formula by Anion-Exchange Chromatography with Pulsed Amperometric Detection after Enzymatic Treatment: Collaborative Study, Final Action 2016.14, *Journal of AOAC International* 103(5), 1301–1317.
- [35] WHO (World Health Organization) (2015), Guideline: sugars intake for adults and children, WHO/NMH/NHD/15.2, <https://apps.who.int/iris/handle/10665/149782> (accessed Apr 1, 2021).
- [36] Chatelan, A. et al. (2019) Total, Added, and Free Sugar Consumption and Adherence to Guidelines in Switzerland: Results from the First National Nutrition Survey menuCH, *Nutrients* 11(5), 1117; <https://doi.org/10.3390/nu11051117> (accessed Apr 1, 2021).

