

Dual-Needle Infinity II Upgrade Kit

Installation Note

General Information

The Dual-needle Upgrade Kit is designed for very fast injection for high throughput and unmatched flexibility to obtain the best configuration for very small as well as very large injection volumes without any compromises on analysis time or performance. This upgrade kit can be installed in any Agilent InfinityLab LC Series Multisampler.

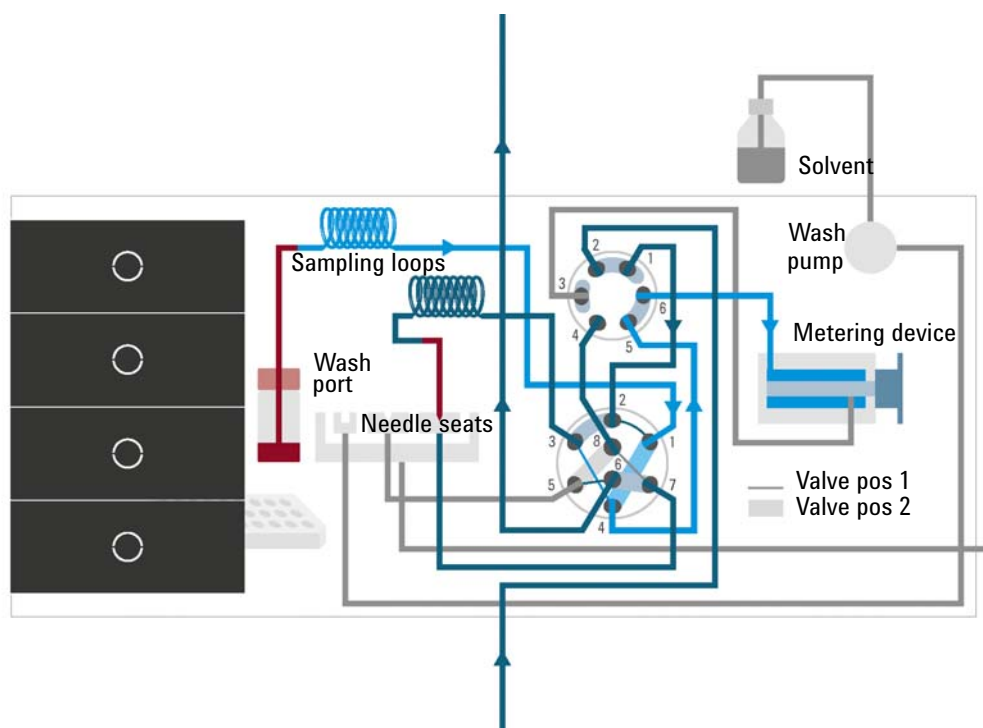

Figure 1 Valve in mainpass (right), drawing sample with left needle

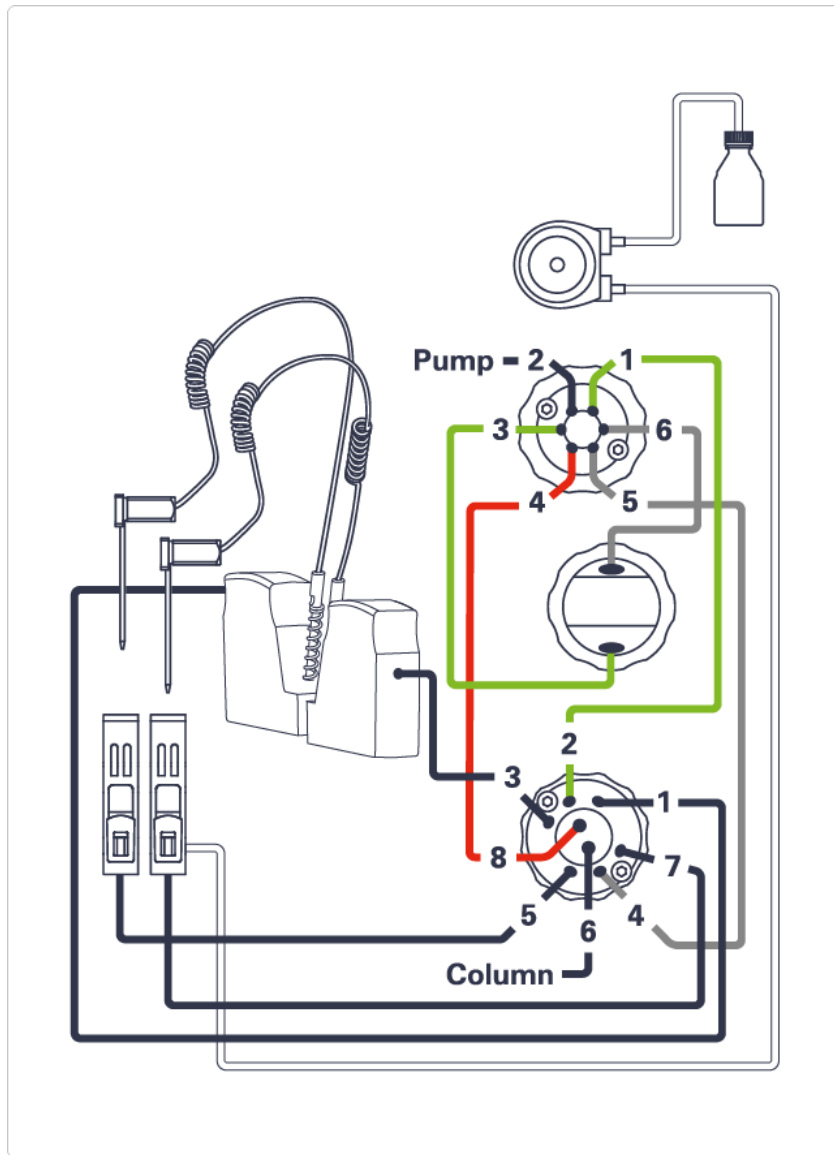

Figure 2 Capillary connections (Dual Needle Option)

NOTE

If the Multisampler dual-needle option is installed you will lose the ability to do multi-draw.

Delivery Checklist

Make sure all parts and materials have been delivered with the upgrade kit. Report missing or damaged parts to your local Agilent Technologies sales and service office.

#	p/n	Description
2	G4267-87012	High Pressure Needle Seat, 0.12 mm (PEEK)
2	G4267-87201	Needle Assembly
1	G4267-60311	Sample Loop 20 μ L right Dual needle for 1290 Infinity II Multisampler
1	G4267-60301	Sample loop 20 μ L left Dual needle for 1290 Infinity II Multisampler
1	G4267-60511	Sample Loop 100 μ L right Dual needle for 1260 Infinity II Multisampler
1	G4267-60501	Sample loop 100 μ L left Dual needle for 1260 Infinity II Multisampler
1	G4267-60044	Needle Port Assembly Station
1	G7167-60000	1260 Dual-Needle Upgrade Hydraulic
1	5067-4256	3pos/6port Peripheral Valve DN 1300 bar
1	5067-4260	2pos/8port Injection Valve Dual Needle 1300 bar
1	G4267-60043	Analytical Head, 100 μ L
1	5500-1225	Capillary ST 0.12 mm x 180 mm SL-SL
1	5500-1226	Capillary ST 0.17 mm x 180 mm SL-SL
1	5500-1227	Capillary ST 0.17 mm x 150 mm SL-SL
1	5500-1228	Capillary ST 0.3 mm x 80 mm SL-SL
1	5500-1229	Capillary ST 0.3 mm x 180 mm SL-SL
1	G7167-60007	Hydraulic 1260 Dual Needle

Installing the Dual-Needle Infinity II Upgrade Kit

The installation of the upgrade kit is divided into three parts:

- removing the standard or multi-wash hydraulic box, see [“Remove the Hydraulic Box”](#) on page 4,
- installing the dual-needle hydraulic box, see [“Install the Hydraulic Box”](#) on page 5,
- configure the dual-needle feature in the CDS, see [“Configure the Dual Needle Instrument Method in OpenLab C.01.06 and Above”](#) on page 10.

Remove the Hydraulic Box

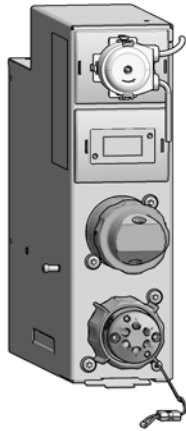

Standard

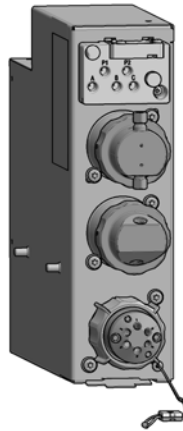

Multiwash

Tools required

Description

- Wrench 1/4 inch
- Hexagonal key, 2.5 mm
- Torx screwdriver Tx 20

Preparations

Switch off the instrument.

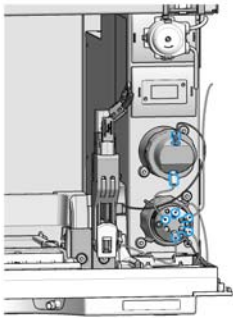
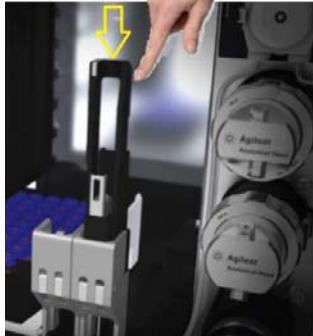
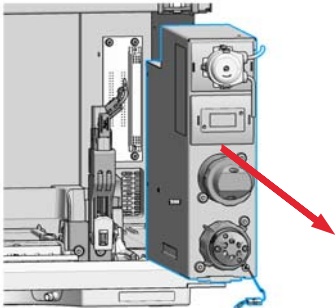
<p>1 Remove the capillaries, the tubings, and the leak sensor which are connected to the hydraulic box.</p> 	<p>2 Press the pusher to unlock the needle assembly.</p> 
<p>3 Remove the needle assembly and sample loop from the single needle instrument. Keep the needle seat.</p>	<p>4 Lift the clip (bottom of the hydraulic box) before you pull out the whole hydraulic unit.</p> 

Install the Hydraulic Box

- 1 Install the dual-needle hydraulic box.

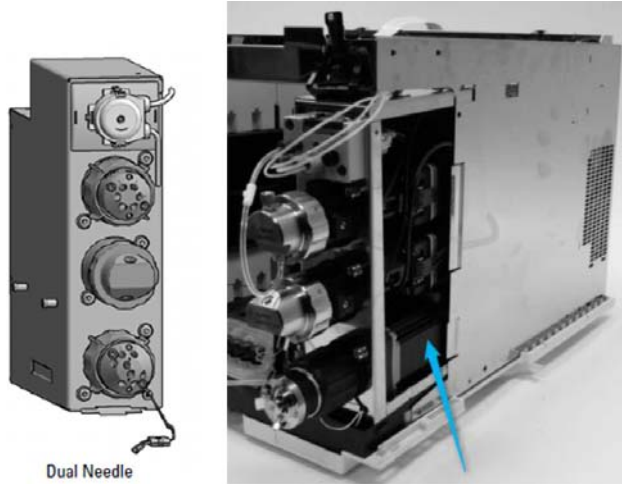

NOTE

Be careful that the hydraulic box is installed correctly and fits exactly in the main chassis.

- 2 Open the screw of the needle parkstation adapter (needle port adapter) and remove the needle parkstation adapter.

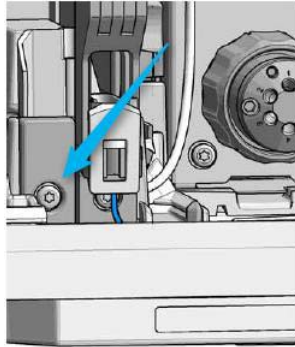

- 3 Install the second needle port assembly into the needle station on the left side.

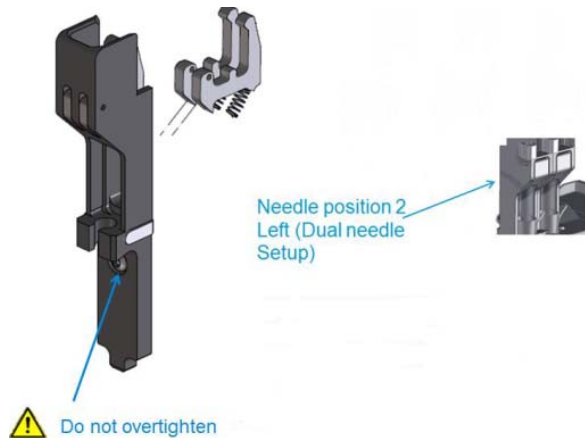

Installing the Dual-Needle Infinity II Upgrade Kit
Install the Hydraulic Box

- 4 Install the dual-needle sample loops, the second needle assembly, the second needle seat, the tubing and the leak sensor which are connected to the dual-needle hydraulic box.

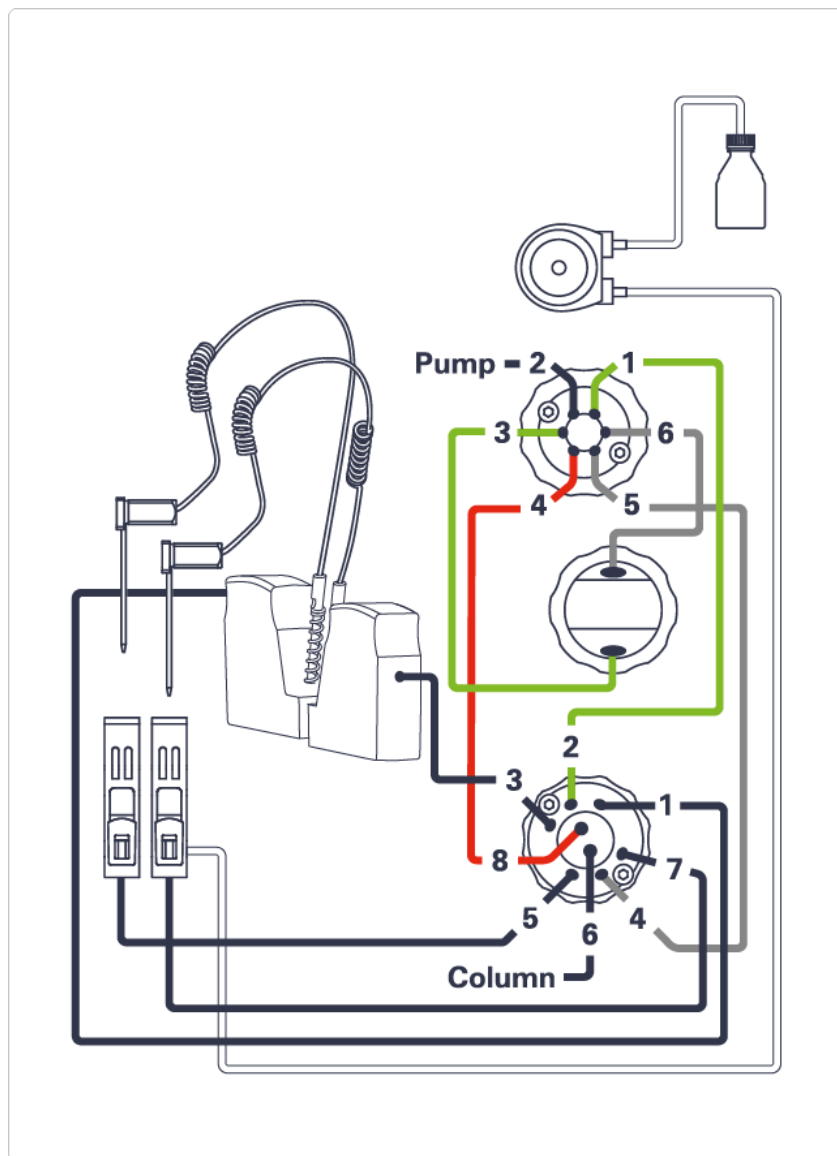
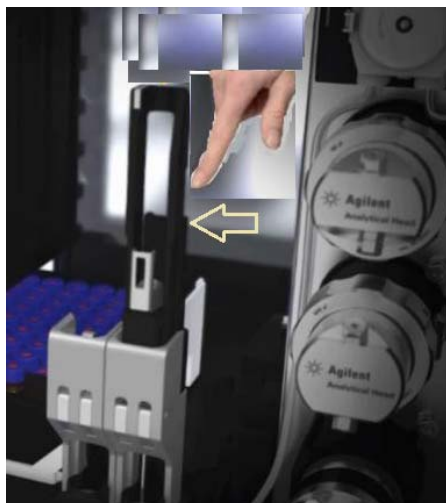

Figure 3 Capillary connections (Dual Needle Option)

NOTE

Be careful when installing the capillaries. Do not mix up the capillary position. Only use dual-needle parts to avoid harm to the instrument later.

- 5 Install the right needle assembly and push the adapter behind the pusher to lock the needle assembly correctly in the parkstation.



- 6 Check the correct installation: The left dual needle sample loop in the rear position, and the right dual needle sample loop in the front position.

Left needle/loop combination into the **Slot 2** and
Right needle/loop combination into *Slot 1*

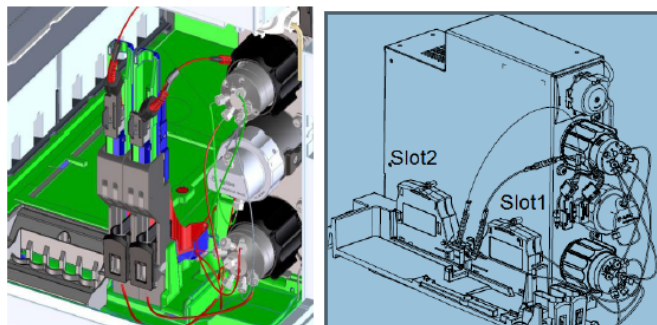

Figure: Additional needle parkstation plus second cartridge slot

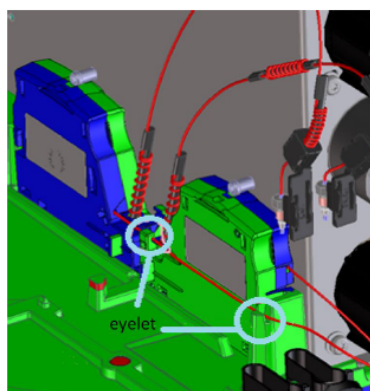
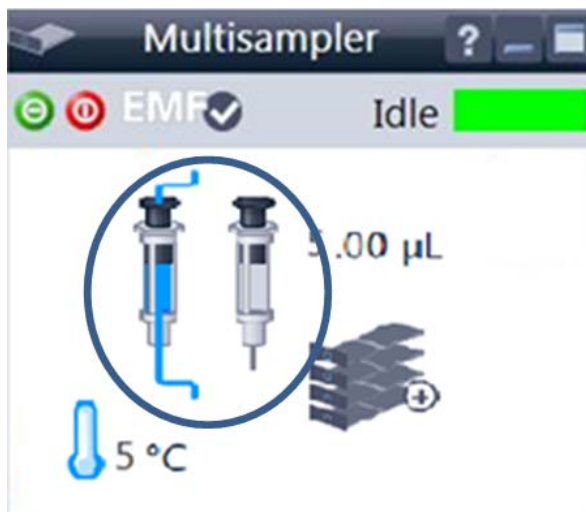

Figure: Eyelets for the left sample loop flex

- 7 Switch on the Multisampler.

Configuration of the Dual-Needle Option in the CDS

The configuration of your controller is not necessary to enable the dual-needle mode. In the GUI you will see the new dual-needle icon.



- 1 Configure the correct dual needle sample loops in the CDS system.

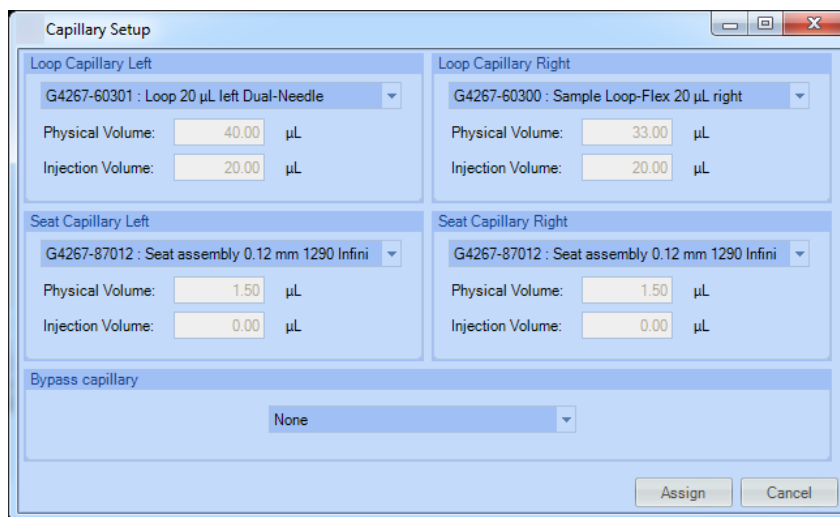

NOTE

The hardware configuration must match the software configuration to avoid harm to the instrument.

2 Prime the tubing with appropriate wash solvent.

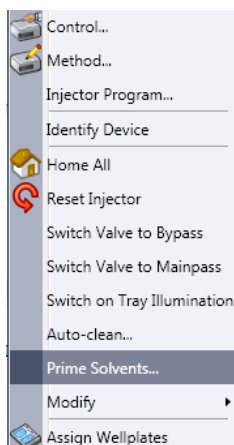

3 Purge the multisampler to flush all capillaries with start condition. For 1290 Infinity II systems this will be done automatically if you start the pump flow. For 1260 Infinity II systems you have to do that manually. Depending on the configuration the purge time can vary.

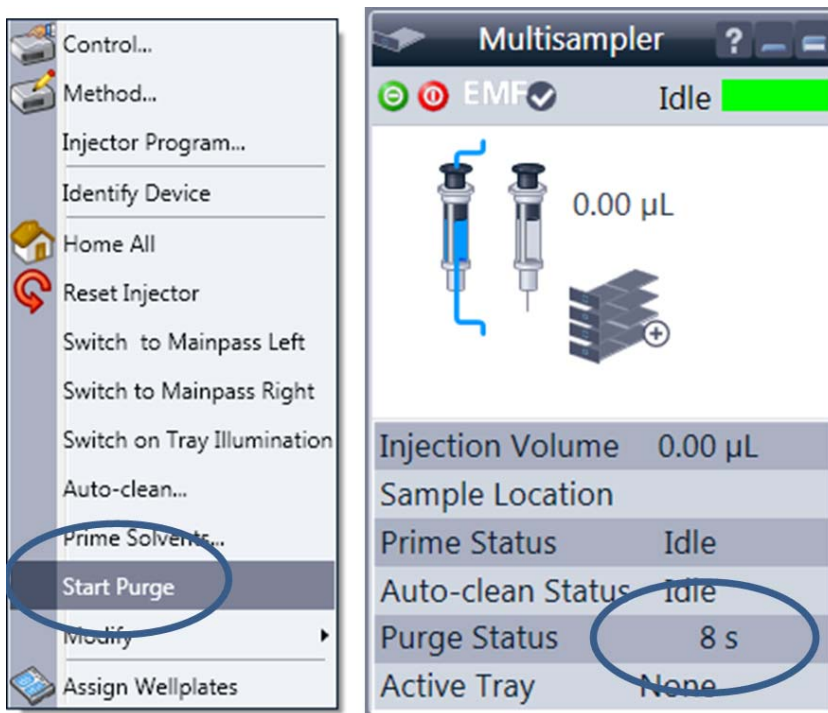

4 Perform a pressure test for the left and the right flow path in Lab Advisor.

Configure the Dual Needle Instrument Method in OpenLab C.01.06 and Above

- 1 Select **Instrument** in the menu.
- 2 Select **Setup Instrument Method**.
- 3 Under **Needle selection**, you can select between right, left or alternating needle (depending on your configuration).

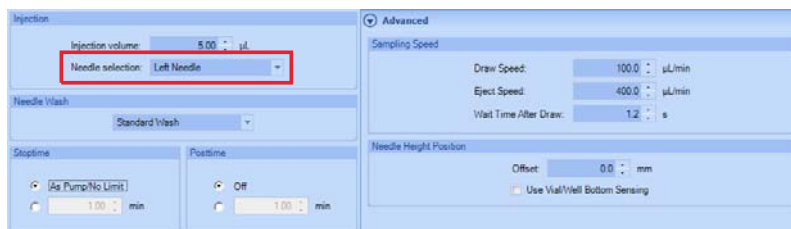

NOTE

For OpenLab CDS, LC driver A.02.12 or higher is required.

- 4 In alternating needle mode, **Smart Overlap** is available. The the next sample is drawn with the other needle after a set time past the current injection. In contrast to overlapped injection, the flow path is flushed (carry-over reduction).

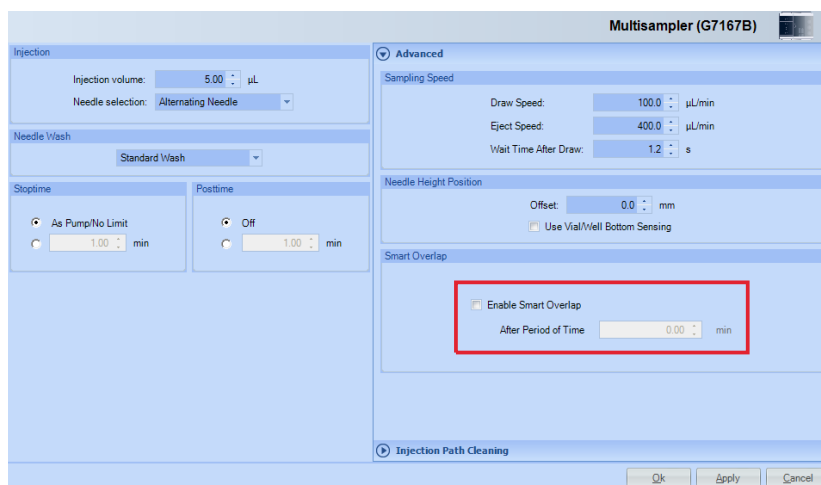

- 5 **Overlapped injection** is available, if two different loops or a bypass capillary are installed.

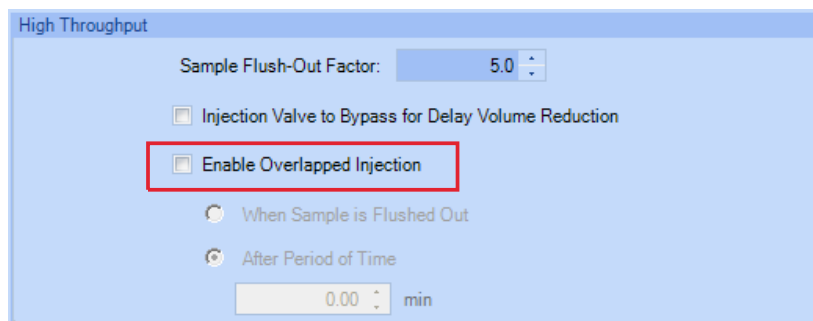

Configure the Bypass mode (Dual Needle option unused) in OpenLAB C.01.06 and Above

This setup is useful if you want to avoid long purge time. If only one path is used on a regular basis, a defined bypass capillary can shortcut one path to allow faster reconditioning.

First the instrument hardware must be changed, see [Figure 4](#) on page 11. The bypass capillary is installed either on the right or the left flow path.

For the left bypass capillary, the connection from port 1 to port 5 has to be used. For the right bypass the capillary connection from port 3 to port 7 has to be used.

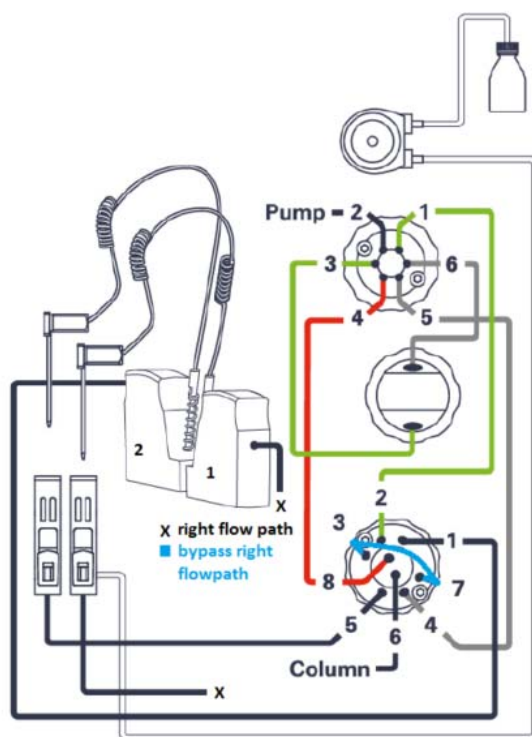

Figure 4 The right bypass capillary is installed

NOTE

Only the listed capillary PN 5500-1238 can be used as bypass capillary (either left or right).

Installing the Dual-Needle Infinity II Upgrade Kit

Configure the Bypass mode (Dual Needle option unused) in OpenLAB C.01.06 and Above

- 1 To set up the bypass capillary in the CDS, right-click into the active area, then select **Modify > Capillaries** from the context menu.

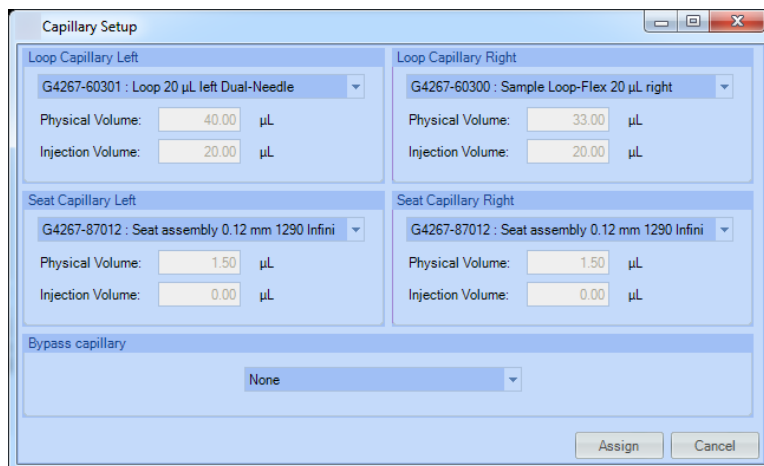

- 2 Select **Right** or **Left** from the **Bypass capillary** dropdown menu, depending on which flow path you want to bypass.

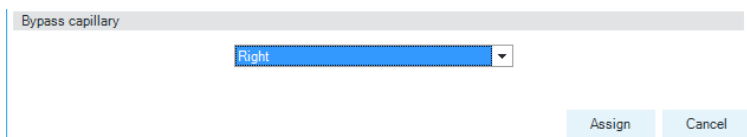

In the active area, you will see that one syringe icon is greyed out, indicating that only one flow path is active. Click **Assign**.



- 3 Select **Instrument** in the menu.
- 4 Select **Setup Instrument Method**.
- 5 Under **Needle selection**, select either **Right Needle** or **Left Needle** (depending on your bypass capillary).

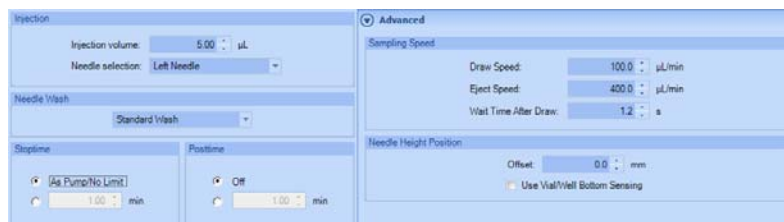

NOTE

The hardware configuration must match the software configuration to avoid harm to the instrument.



G7167-90220 Rev. D
Edition: 02/2019

Printed in Germany

© Agilent Technologies, Inc 2016-2019

Agilent Technologies, Inc
Hewlett-Packard-Strasse 8
76337 Waldbronn
Germany