



## **EVOQ™ GC-TQ**

- The Gas Chromatographers' Triple Quadrupole Detector

# Introducing the EVOQ GC-TQ System

The EVOQ GC Triple Quadrupole (TQ) detector is a comprehensive solution for your most demanding gas chromatography applications. It delivers unrivalled bench-space savings, the result of an innovative 'lens-free', elliptical ion-path design that delivers ultra-high sensitivity and chemical noise reduction - performance you would expect when innovation merges with a legacy of reliability.

If you are seeking new solutions and real innovation, we invite you to experience the revolutionary design of the EVOQ GC-TQ system. The EVOQ GC-TQ delivers the performance you would expect from Bruker when true innovation is combined with an extensive legacy of reliability.

## EVOQ GC-TQ Features

- **Simple Tuning**  
'Lens-Free' ion path for higher stability and sensitivity
- **More Sensitivity**  
Active-Focusing q0 uses helium molecules to increase ion transmission
- **Higher S/N**  
Elliptical ion-path design that results in virtually zero neutral or chemical noise
- **Easy MRM Method Set Up**  
Simply type the name of the compound and the MRM information auto-fills
- **Unrivalled NCI Performance**  
High capacity turbo-pump standard with every EVOQ GC-TQ
- **Eliminate Re-injections**  
Extended Dynamic Range (EDR) detector with unique Integrated-Quad design



## ● Why Choose the EVOQ GC-TQ System?

Benefit from the innovations provided by the EVOQ GC-TQ and increase the confidence in your results while future-proofing your laboratory. The unique elliptical ion-path that is fundamental to the EVOQ GC-TQ virtually eliminates neutral or chemical noise. Other innovations such as the 'lens-free' design and the active focusing q0 help make quantitative analysis of difficult samples routine.

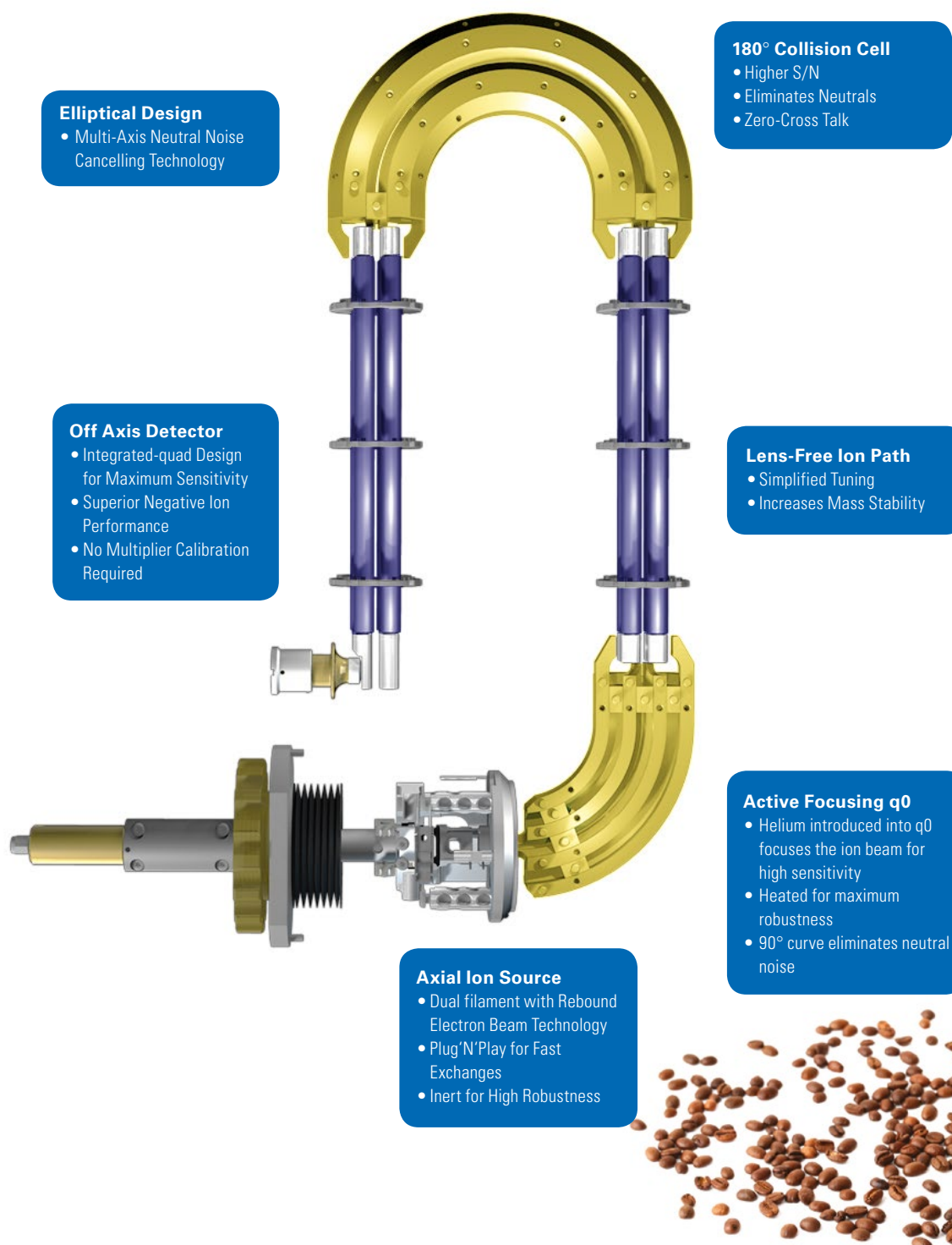

# Peace of Mind, Delivered

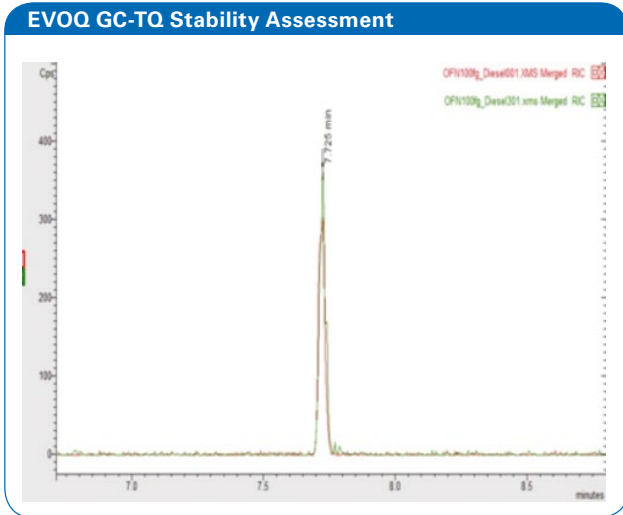

Analytical laboratories may have different applications, but they share many of the same challenges. The EVOQ GC-TQ is designed to effortlessly analyze thousands of samples from even the dirtiest of matrices such as sewer run-off, food homogenates, oil field sludge, whole blood and tissue. When your QuEChERS assay demands the utmost in reliability and robustness, or your steroid assay requires superior sensitivity, simply use the EVOQ GC-TQ.

Industry leading robustness indicated by 300 consecutive injections of 1% Diesel Oil matrix containing 100 fg OFN over a one week period. The MRM ( $m/z > 222$ ) traces show injection No. 1 and injection No. 301.

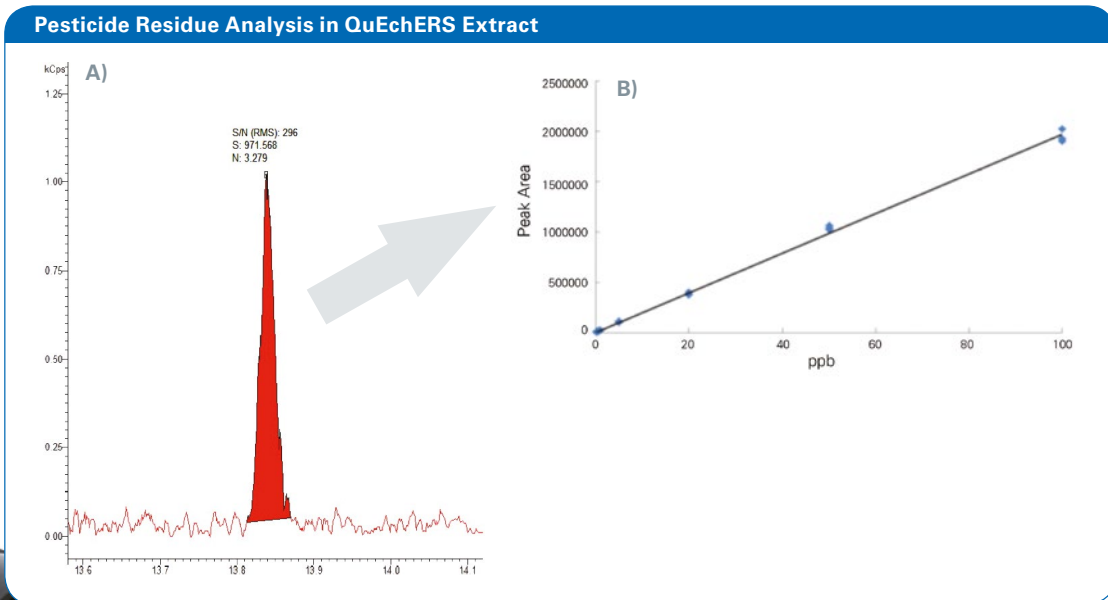
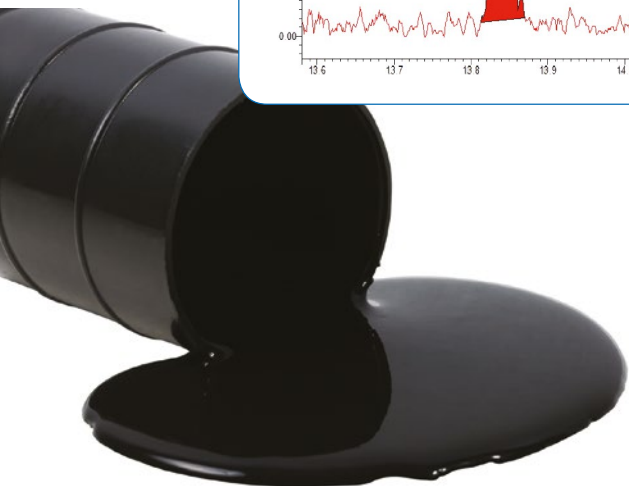

Figure A) 0.1 ppb Heptenophos in QuEChERS extract  
Figure B) Routine dynamic range, sensitivity and precision of the EVOQ GC-TQ as indicated by excellent linearity range of pesticide Heptenophos in QuEChERS extract matrix of mixed color peppers from 0.1 to 100 ppb. Note also the excellent precision down to the 0.1 ppb.



# ● Easy to Use Software Increases Productivity



## MRM Method Builder

With the EVOQ GC-TQ, you don't need to know the MRM transition of an analyte, let the software auto-fill it for you! Simply drag in the name of your compound from the factory installed compound library that contains over 2500 MRM transitions, and let the software set up the method, and manage the TQ's duty cycle.

The fast-scanning capability of the EVOQ GC-TQ allows multiple transitions for each compound to be optimally monitored during a single analytical run. By maintaining each compound's unique retention time, the number of simultaneous transitions is reduced, leading to the most efficient duty cycle and thereby increasing assay sensitivity.

### Compound Based Scanning

Name	Retention Time	RT window	Calc Number	Scan Type	Scan Time	Priority
1 Benzofuran	3.30	0.25	12121-12.0	MS/MS	30	1
2 Benzofuran	3.20	0.25	18874-46.1	MS/MS	30	1
3 Benzofuran	3.30	0.25	82560-54.1	MS/MS	30	1
4 Benzocyclobutene	3.20	0.25	188-41.8	MS/MS	30	1
5 Benzene	3.40	0.25	42574-83.1	MS/MS	30	1
6 Benzothiazole	3.50	0.25	104-79.2	MS/MS	30	1
7 Benzopyrene	3.80	0.25	18181-86.1	MS/MS	30	1
8 Butane	4.30	0.25	23829-47.9	MS/MS	30	1
9 Chloroethane	4.10	0.25	1887-46.8	MS/MS	30	1
10 Cyclohexane	4.20	0.25	12315-67.8	MS/MS	30	1
11 Cyclohexane	4.50	0.25	96-38.9	MS/MS	30	1
12 Ethylpropane	4.30	0.25	12184-46.4	MS/MS	30	1
13 Ethylpropane	4.10	0.25	22224-83.8	MS/MS	30	1
14 Fluorobenzene	3.50	0.25	17614-41.9	MS/MS	30	1
15 Fluorobenzene	4.30	0.25	81213-25.9	MS/MS	30	1
16 Heptane	6.25	0.25	485-73.8	MS/MS	30	1
17 Heptane	6.50	0.25	121-75.8	MS/MS	30	1
18 Hexane	6.00	0.25	22124-87.1	MS/MS	30	1
19 n-Propylpropane(M)	4.75	0.25	96-43.7	MS/MS	30	1
20 Propene	4.80	0.25	22183-86.2	MS/MS	30	1
21 Propene	5.20	0.25	41188-88.7	MS/MS	30	1
22 Propene	7.20	0.25	22123-88.9	MS/MS	30	1
23						
24						
25						

Precursor	Product	Collision Energy	Q1 Resolution	Q3 Resolution	Time (%)	Qualifier Ion	Qualifier Ratio	Qualifier Ion
1	288.00	162.00	16.00	8.70	8.70	33.23%		8.80%
2	288.00	152.00	16.00	8.70	8.70	33.23%		15.00%
4	288.00	117.00	36.00	8.70	8.70	33.23%		28.00%
6								

### Industry First Triple Quadrupole Software That Lets You Think Like a Chromatographer



# Gas Chromatographs

## An Infusion of Innovation with a Legacy of Reliability

The GC is a key part to the reliability, robustness, and sensitivity of any GC-MS analysis. Bruker's philosophy of innovation is highlighted by the use of two GCs built to support the ultra-sensitive EVOQ GC-TQ. The compact 436-GC and the versatile 456-GC can accommodate two columns in the oven and are available with new backflush technology and the innovative ChromatoProbe™. The GCs are also equipped with the multilanguage touchpad display supporting 13 languages and enabling MS control.

### 436-GC

Compact design for those focused on routine applications requiring maximum throughput using one or two injectors

- Select up to 2 injectors: Split/Splitless (SSL), Programmable Temperature Vaporization (PTV)
- Support one GC detector and the mass spectrometer
- High precision electronic pressure control
- All temperature zones up to 450 °C
- Automated with Model 8400/8410 or CTC liquid/headspace autosampler

### 456-GC

Versatile design with additional injector and detector options for laboratories seeking multipurpose analysis using both GC and GC-MS

- Select up to 3 injectors: SSL, PTV
- Add up to 3 GC detectors-FID, ECD, TCD, PFPD
- High precision electronic pressure control
- All temperature zones up to 450 °C
- Automated with Model 8400/8410 or CTC liquid/headspace autosampler

Bruker has now set the industry standard for ease-of-use: Basic operation of EVOQ GC-TQ systems can be directly controlled from the multi-language touchpad on the gas chromatograph. Automatic tuning, along with tune-to-target for meeting specific USEPA methods can be done with a touch of a button. And the MS can be vented and pumped down from the interface for the ultimate in easy maintenance.

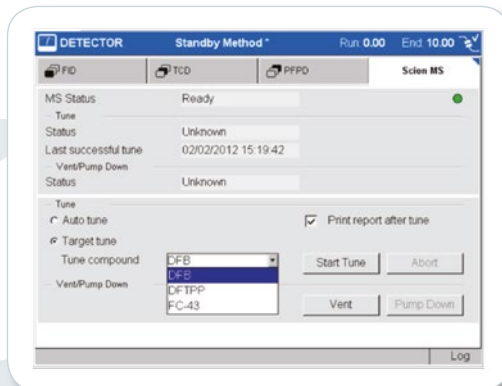

436-GC

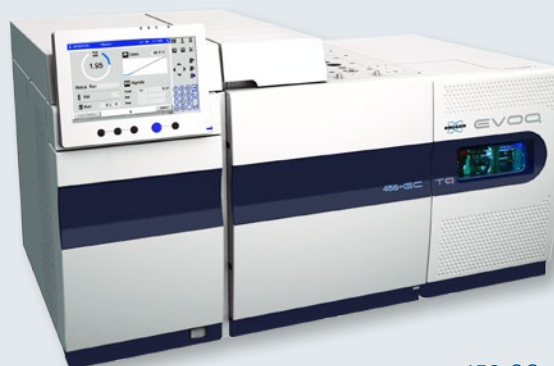

456-GC

## ● Additions to Enhance System Capability and Performance

The perfect addition to the EVOQ GC-TQ PTV inlet is the backflush option. Complex sample matrix can quickly ruin the chromatographic performance of your GC column. However, the PTV with Bruker's "backflush" technique can reliably divert the higher boiling sample matrix away from the column. The benefits of this accessory are many:

- Run more samples per day - decrease analysis times as the heavy components are quickly eliminated
- Save time by eliminating column bake out
- Preserve column performance for extended period of time

### **ChromatoProbe™**

Added Versatility for Superior Analysis of Solids, Liquids, and Slurries.

Compounds such as street drugs, industrial solids, synthetic organic products, and plant tissues that normally are not considered amenable to GC-MS analysis can be easily investigated with the ChromatoProbe.

Samples are introduced into the PTV injector via disposable micro-vials. Non-volatile or thermally degraded components from the sample remain in the micro-vial allowing the system to remain clean.

ChromatoProbe Benefits:

- Increase uptime
- Minimize system contamination with disposable micro-vials and split injections
- Directly desorb samples in the PTV injector without added hardware (unique Direct Sampling Capability)

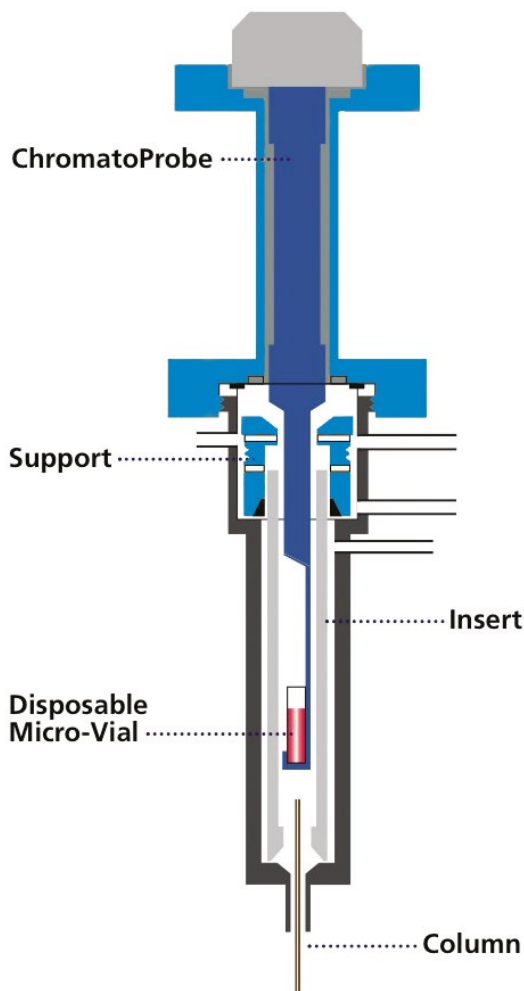

For research use only. Not for use in diagnostic procedures.

---

 **Bruker Daltonik GmbH**

Bremen · Germany  
Phone +49 (0)421-2205-0  
Fax +49 (0)421-2205-103

**Bruker Daltonics Inc.**

Billerica, MA · USA  
Phone +1 (978) 663-3660  
Fax +1 (978) 667-5993

[ms.sales.bdal@bruker.com](mailto:ms.sales.bdal@bruker.com) - [www.bruker.com](http://www.bruker.com)