

FTIR

TALK LETTER

vol. 17
July 2012



Gas Analysis — 02

Measurement Method ABCs:
Specular Reflection Method — 07

Q&A:
How does Raman spectroscopy
differ from infrared spectroscopy? — 11

Gas Analysis

Spectroscopy Business Unit, Analytical & Measuring Instruments Division, Hiroshi Ota

Gas chromatography is generally used for the qualitative and quantitative analysis of gases. However, infrared spectroscopy using a gas cell can also be used as introduced in the previous FTIR TALK LETTER.

Differences with Gas Chromatography

Gas chromatography involves introducing the sample into a column and separating the sample components using the interaction between the mobile phase and stationary phase. Separation, qualification, and quantitation are performed by detecting the differences in physical properties between the components and the mobile phase.

Infrared spectroscopy measures the IR absorption spectrum of the measurement target gas introduced into the gas cell. Qualification and quantitation are performed from the wave numbers of the characteristic peaks and peak intensities of the measured gas.

As the measurements are performed at the time the target gas is introduced into the gas cell and the measured IR absorption spectrum is used for qualification and quantitation, the analysis can be completed rapidly without pretreatment. As this is a

non-destructive analysis using infrared light and does not change the gas composition, the gas can be reused after the analysis is complete. Infrared spectroscopy can therefore be used to configure a system for the continuous monitoring of fluctuations in gas composition and concentration during reactions. Infrared spectroscopy may seem to be the ideal measurement method for such gas analysis. However, as infrared radiation has weaker energy than other electromagnetic radiation, high measurement sensitivity cannot be expected. In addition, as the sensitivity is significantly affected by the degree of molecular polarity (more accurately, fluctuations in dipole moment due to molecular vibrations) of the substance, the method suffers from sensitivity differences and limitations on the types of gas it can analyze. (See Table 1.)

Table 1 Comparison of Gas Analysis by Infrared Spectroscopy and Gas Chromatography

| Method | Infrared Spectroscopy | Gas Chromatography |
|--------------|---|---|
| Advantage | <ul style="list-style-type: none">• Extremely fast analysis by directly measuring gas as it is introduced into the cell (approx. 1 minute)• Non-destructive analysis of flowing gas permits reuse of the gas after the analysis is complete, which simplifies exhaust gas handling.• Simultaneous measurement of multiple components• Real-time monitoring of continuously changing gases, without pretreatment• Simple instrument maintenance• By changing the optical path length, measurements over a wide concentration range from percent to ppm level. | <ul style="list-style-type: none">• Select from multiple columns types and detectors types to enhance detection sensitivity of the measured gas.• High-sensitivity detector permits highly sensitive measurements to ppt order. |
| Disadvantage | <ul style="list-style-type: none">• IR absorption analysis results in differences in sensitivity due to gas type.• Due to IR absorption across a wide range, water vapor in the sample may become an inhibitory component.• Does not permit analysis of gases with no molecular polarity, such as diatomic molecules (F₂, O₂, etc.).• Qualification/quantitation may not be possible when IR absorption peaks are superimposed for a measured gas with multiple components. | <ul style="list-style-type: none">• Detection after column separation results in long analysis times. (Approx. 10 to 30 minutes, depending on coexisting components)• Carrier gas is required for analysis.• Maintenance for valve leaking, column deterioration, and deterioration in the detector cell results in high running costs. |

Qualitative Analysis

Qualification by infrared spectroscopy is based on the peak frequencies and peak intensities in the absorption spectrum of the gas introduced into the gas cell. The gas type can also be identified using a spectral search program in a commercial gas spectrum database. Fig. 1 shows the gas spectrum for hydrogen fluoride (HF)

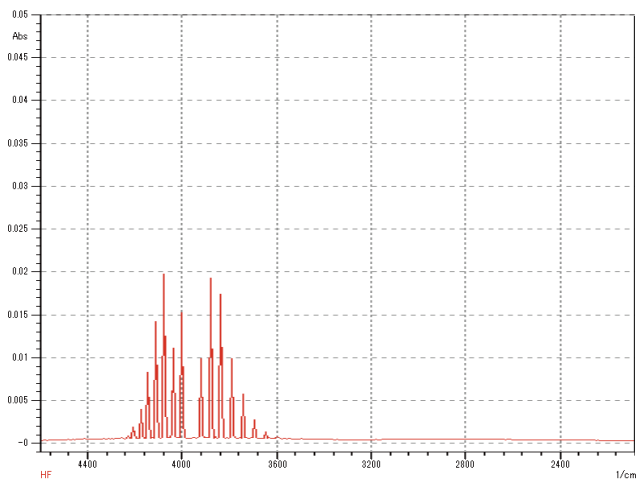

Fig. 1 Gas Spectrum for Hydrogen Fluoride (HF)

and Fig. 2 shows the gas spectrum for hydrogen chloride (HCl).

As characteristic peaks exist in a certain frequency region for each functional group, the gas structure can be identified from the peak frequency information held in the spectrum. (See Table 2.)

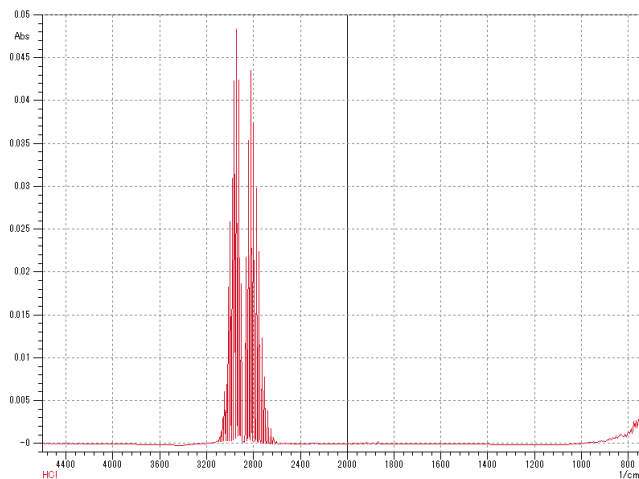

Fig. 2 Gas Spectrum for Hydrogen Chloride (HCl)

Table 2 Major Functional Groups and Absorption Frequency Regions

| Major Functional Group | Absorption Frequency Region | Sample Example |
|------------------------|-------------------------------|---|
| O-H | 3670-3580 1385-1185 | Alcohols, Phenols, Carboxylic acids |
| N-H | 3500-3300 1650-1600 1100-1000 | Amines, Amides |
| C-H | 2810-2700 1380-1220 | Aldehydes, Alcohols |
| C-O | 1250-1000 | Esters, Carboxylic acids, Alcohols |
| C=O | 1800-1700 | Carboxylic acids, Esters, Aldehydes, Amides |

References

David Welti (1970) Infrared Vapour Spectra: Heyden & Son Ltd.

Quantitative Analysis

Quantitation of gases is performed with respect to specific peaks on the IR absorption spectrum using a preset calibration curve. However, care is required, as the peak intensity can change due to various measurement conditions.

The peak intensities in an IR absorption spectrum for a gas differ according to factors such as the gas cell length and internal pressure, number of integrations during measurements, and resolution. Therefore, accurate quantitation values should ideally be obtained by introducing a standard gas of known concentration into the gas cell used for quantitation, measuring it under the actual analysis conditions, and using the measured spectrum to create a calibration curve for the analysis. Quantitation with a commercial reference gas database can be used when the quantitation accuracy is not required.

If the gas pressure changes between measurements, the pressure must be measured during the analysis and used to correct the quantitation values.

Table 3 shows measures to enhance the sensitivity of gas analysis and associated precautions.

Generally, increasing the gas cell optical pathlength permits gas quantitation at lower concentrations. If a multipath gas cell (with a mirror at each end to produce multiple reflections) is selected to increase the measurement sensitivity, the throughput drops as the number of reflections increases, due to the smaller infrared light beam diameter in the cell and the greater number of reflections off the mirrors.

For a multipath gas cell with an optical pathlength of several meters, the throughput drops to just a few

percent. Therefore, a high-sensitivity MCT (HgCdTe) detector must be used, as a normal pyroelectric detector is unable to provide adequate sensitivity. An MCT detector requires cooling by liquid nitrogen and has a cutoff frequency at the long-wavelength side, such that no sensitivity can be obtained in longer wavelength regions.

Conversely, increasing the number of integrations improves the sensitivity. However, increasing the sensitivity by a factor of N increases the measurement time by a factor of N^2 if the same measurement conditions (resolution and mirror speed) are used. When the measurement resolution is increased, the peaks become sharper in the spectrum. However, as the aperture is set according to the set resolution, increasing the measurement resolution results in decreased throughput, such that no improvement in sensitivity can be expected.

The peak with greatest intensity for the gas is normally used for quantitation. As gas peaks often overlap when attempting quantitation of multiple gases, it is important to check the measured gas spectrum and the spectrum of the gas for quantitation when setting the peak. It is also important to carefully select the peak if the measured gas peak is overlaid over the peak for a gas component from the atmosphere, such as carbon dioxide or water vapor.

When measuring gases with extremely close peaks, high-resolution measurements of the IR absorption spectrum may enable separation of the nearby peaks to permit qualitative and quantitative analysis.

Table 3 Gas Analysis Conditions and Sensitivity

| Conditions | Measure to Enhance Sensitivity | Precautions |
|------------------------|---|---|
| Gas cell length | Increase the gas cell pathlength. Sensitivity should increase in proportion to the pathlength. | Increasing the cell pathlength reduces the throughput. If a multipath gas cell with a mirror at each end is used, the throughput drops as the number of reflections increases. The reduced throughput due to the smaller IR light beam diameter and mirror reflection losses affects the sensitivity. If the throughput is reduced, a high-sensitivity MCT (HgCdTe) detector is often used, but the inherent wavelength characteristics of a quantum detector do not permit measurements at longer wavelengths. |
| Number of integrations | Increase the number of integrations. To increase the sensitivity N times, increase the number of integrations N^2 times. | Increasing the number of integrations increases the sensitivity but extends the measurement time. It is unsuitable for flow measurements. |
| Resolution | Increase the resolution. Increasing the resolution increases the peak intensities. | As this increases the time for each measurement, it is unsuitable for flow measurements. If the light intensity is restricted by an aperture, the decreased throughput prevents improvements in sensitivity. |



Table 4 shows examples of gas components for combustion gas analysis and the peak frequencies selected for quantitation.

Table 4 Quantitation Peaks for Combustion Gas Components, Set Using Standard Gases

| Component Name | High-Frequency Baseline | Peak | Low-Frequency Baseline |
|-----------------|-------------------------|------|------------------------|
| CO | 2233 | 2170 | 2000 |
| CO ₂ | 2391 | 2359 | 2205 |
| SO ₂ | 1400 | 1374 | 1300 |
| NO | 1971 | 1907 | 1751 |
| NO ₂ | 1667 | 1628 | 1540 |
| HCl | 2950 | 2944 | 2943 |
| HBr | 2614 | 2619 | 2598 |
| HF | 4045 | 4037 | 4020 |
| HCN | 720 | 710 | 712 |

(Units: cm⁻¹)

Measurement of Changes in Gas over Time

As gas analysis by infrared spectroscopy requires no pretreatment time before quantitation and offers short measurement times, it allows real-time quantitation of a measured gas as its concentration changes over time after it is introduced into the flow cell.

It can therefore be used to measure the changes over time of the types and concentration of gases generated by combustion reactions, chemical reactions, or thermal analysis.

However, be aware of the following points when using a flow cell to measure changes over time.

- Gas cell capacity

Increasing the gas cell capacity to improve the measurement sensitivity requires more time to replace the gas inside the cell and reduces the temporal resolution.

When the cell is used to measure changes over time, select a gas cell with a smaller capacity, even if the cell pathlength is the same. (This gives priority to temporal resolution at the expense of decreased throughput.)

- Gas cell and flow channel temperature

Cold spots in the flow channel or gas cell allow a readily adsorbed gas to be adsorbed on the wall, which reduces the temporal resolution.

Conversely, increasing the gas cell temperature too high increases the total IR intensity in the MCT detector. This reduces the relative interference of infrared light from the FTIR and reduces the sensitivity. Do not increase the gas cell temperature higher than necessary.

- Types of analyzed gas

If the analyzed gas contains a large amount of moisture, it can inhibit the qualification or quantitation of other gases. In this case, the moisture must be eliminated from the analyzed gas in advance using a membrane dryer or another dryer.



Application to Automated Quantitation Systems

The optional macro program functions incorporated in the FTIR data processing software can be used to configure a variety of automated gas analysis systems.

Fig. 3 below shows an example of an end-point monitoring system for the reaction furnace in a factory connected with a distributed control system (DCS).

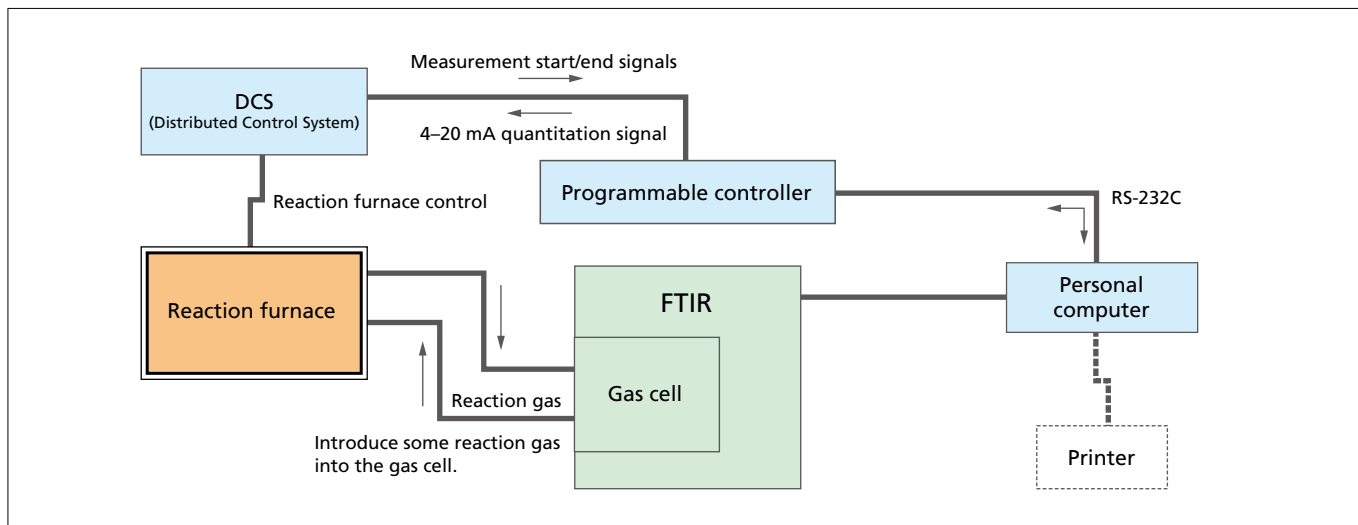
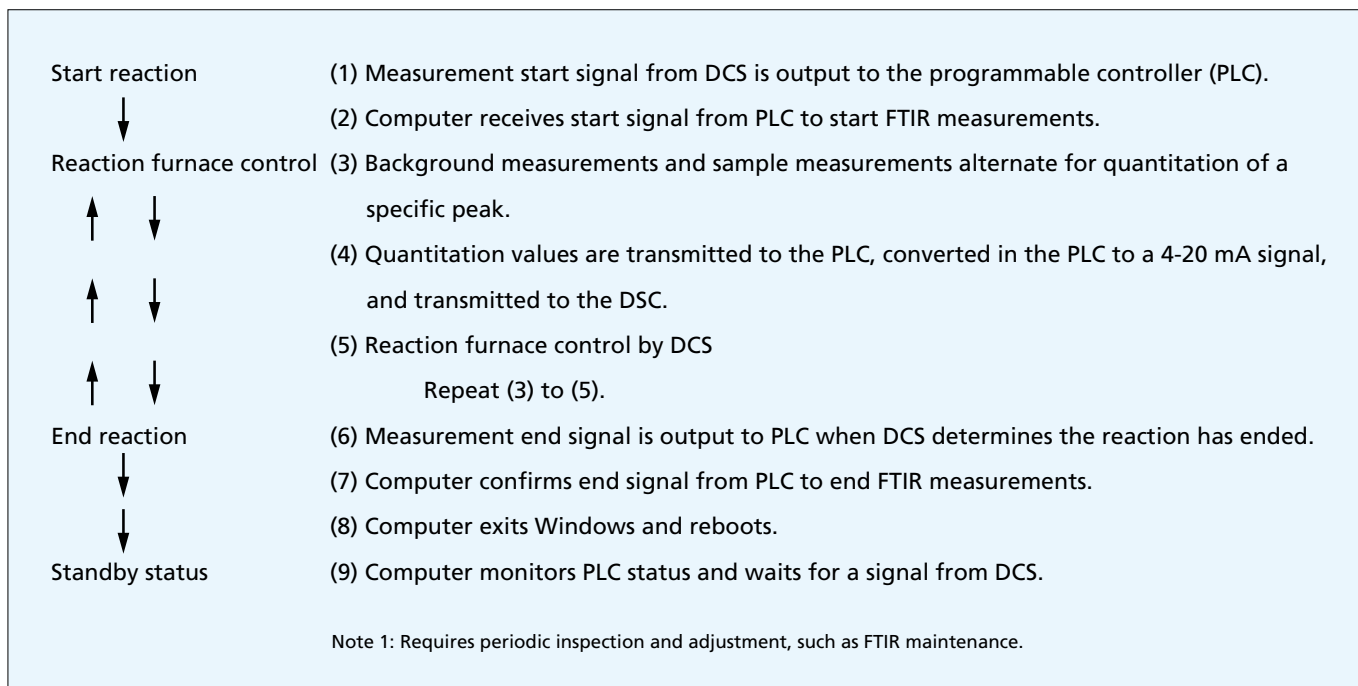

Fig. 3 Reaction Furnace Gas Monitoring System

Example of Measuring Procedure

The procedure for FTIR measurement of gases generated inside the reaction furnace using a distributed control system (DCS) is described below. Starting and stopping measurements is controlled by the DCS. When measurements start, the quantitation value

for a specific gas peak is transmitted to the DCS as 4–20 mA. Quantitation of the component gas peaks at fixed intervals before and after the reaction allows the DCS to evaluate when the reaction is complete. The DCS performs this control automatically, enabling unmanned operation of the FTIR. (Note 1)



Measurement Method ABCs: Specular Reflection Method

Tokyo Applications Development Center, Analytical Applications Department, Analytical & Measuring Instruments Division,
Shoko Iwasaki

Analysis by FTIR can be broadly categorized into transmission methods and reflection methods. Reflection methods include ATR, specular reflection, and diffuse reflection methods, and reflection absorption spectrometry. FTIR TALK LETTER Vol. 16 introduced the application of diffuse reflection to the measurement of solids and powders with rough surfaces. This FTIR TALK LETTER explains the measurement principle and characteristics, and presents application examples, of specular reflection methods that are effective for measurements of thin films and painted coatings on metal substrates.

1. Introduction

When light shines on a sample surface at a certain angle of incidence, it reflects off at an equal angle. Such light is called specular reflected light. An IR spectrum obtained from specular reflected light is called a "specular reflectance spectrum." Methods used for measuring specular reflected light include specular reflection spectrometry, with the angle of incidence of the infrared light beam close to perpendicular, and reflection absorption spectrometry, which uses an angle of incidence close to horizontal.

Specular reflectance measurements include absolute reflectance measurements and relative reflectance measurements. Relative reflectance measurements measure the reflectance of the sample with respect to a reference aluminum or gold mirror. Conversely, absolute reflectance measurements determine the reflectance of the sample with respect to the incident light, without using a reference mirror.

2. What Are Specular Reflectance Measurements?

Fig. 1 (A) to (C) shows schematic diagrams of specular reflectance measurements. The data obtained by specular reflectance measurements differ according to the sample.

(A) Organic Thin Film on a Metal Substrate

The incident light passes through the sample, is reflected off the metal substrate, and passes through the sample again (beam a). The spectrum obtained is similar to an

absorption spectrum acquired using a transmission method and is known as a "reflection absorption spectrum." Although a specular reflectance component (beam b) from the film surface also exists, it represents a small proportion of the total, so that the measured result is the IR spectrum produced by beam a.

(B) Relatively Thick Organic Film on a Substrate or Bulk Resin

Pretreatment, such as thin slicing or rolling, is required to measure such a sample using a transmission method. However, specular reflection methods provide more convenient measurements, as the sample thickness is not relevant.

If the sample is relatively thick, light beam a that enters the sample is absorbed and scattered or passes through the sample. Therefore, only specular reflected light from the sample surface (beam b) is detected. The peaks of this specular reflectance spectrum are distorted, in the absorption region, toward the first-order differential form.

This results from an abnormal scattering phenomenon, which is caused by large differences in the refractive index before and after the peaks. The distorted spectrum can be subjected to Kramers-Kronig (K-K) analysis to approximate an absorption spectrum.

(C) Thin Film on Substrate

As the sample has a flat surface and uniform thickness, it is a mixture of (A) and (B). Consequently, the information obtained is a mixture of a reflection absorption spectrum and a reflectance spectrum. However, the two beams (a and b) mutually interfere to form interference fringes. The sample thickness can be determined from these interference fringes.

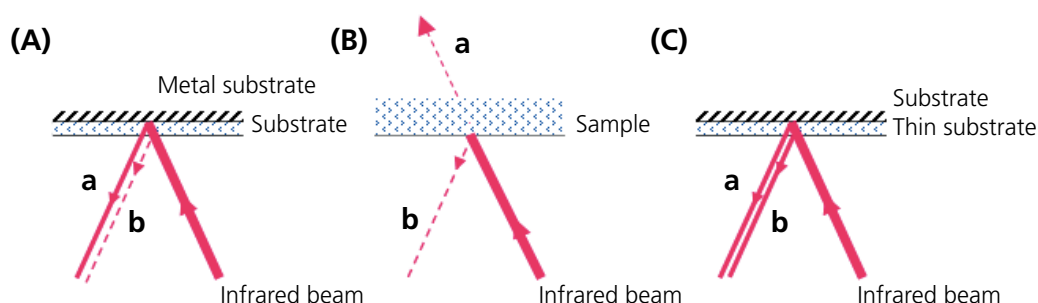

Fig. 1 Schematic Diagrams of Specular Reflectance Measurements

3. Specular Reflectance Attachment

Fig. 2 shows the external appearance of the SRM-8000 Specular Reflectance Attachment and Fig. 3 shows the optical system. The mean angle of incidence is 10 degrees.

First, put the reference mirror on the sample stage and measure the background. Next, place a sample and measure its reflectance. The specular reflectance spectrum is obtained from the ratio of the reflectance of the standard mirror and sample.



Fig. 2 Appearance of SRM-8000 Specular Reflectance Attachment

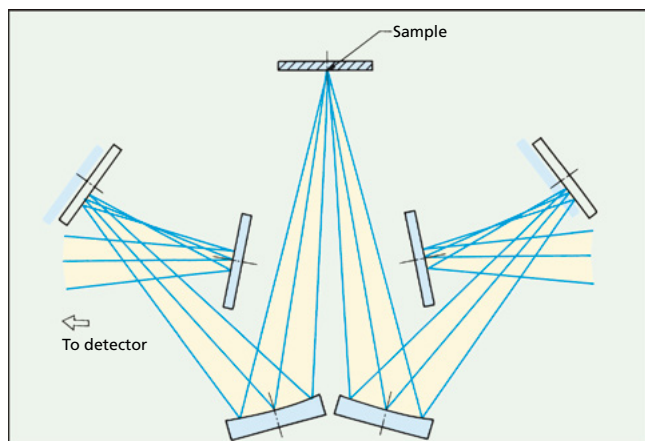

Fig. 3 SRM-8000 Specular Reflectance Attachment Optical System

4. Specular Reflectance Spectrum and Kramers-Kronig Analysis

Fig. 1 (A) shows a measurement of the inner wall of an aluminum can using the specular reflectance attachment. The measured results are shown in Fig. 4. It indicates the coating material on the aluminum can inner wall to be epoxy resin.

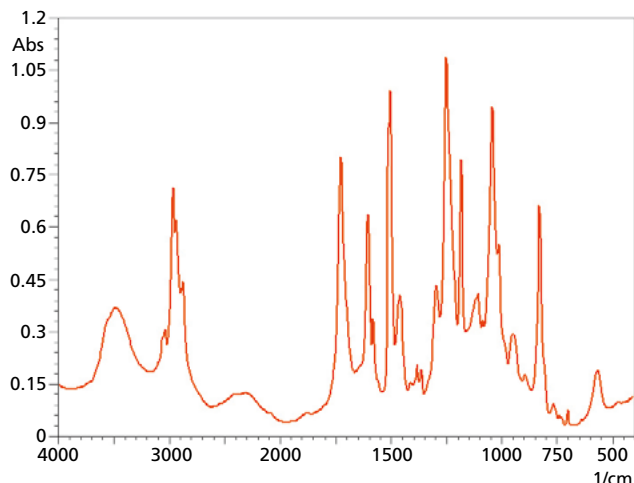

Fig. 4 Reflection Absorption Spectrum of Aluminum Can Inner Wall

The peak intensities in the IR spectrum obtained are dependent on the film thickness. When the film is thick, the peaks become saturated; when the film is extremely thin, it becomes more difficult to obtain the absorption peaks due to the short pathlength. Consequently, reflection absorption spectrometry or the ATR method is used for thin-film analysis. For details, refer to FTIR TALK LETTER Vol. 7.

Fig. 1 (B) shows an example of the measurement of a 0.5 mm-thick acrylic resin sheet. Fig. 5 shows the specular reflectance spectrum.

It shows that the specular reflectance spectrum is distorted toward the first-order differential form. Kramers-Kronig (K-K) analysis was applied to approximate an absorption spectrum. Fig. 6 shows the IR spectrum produced after processing.

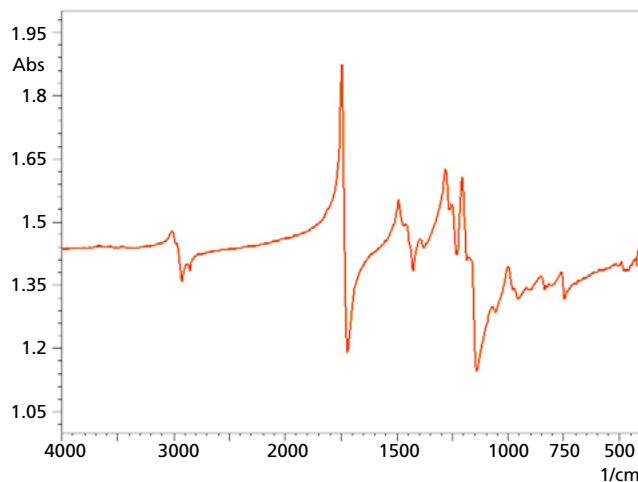

Fig. 5 Specular Reflectance Spectrum of Resin Sheet

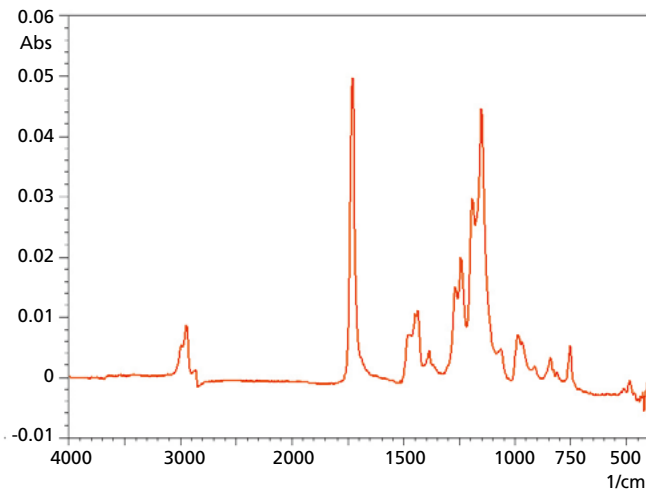

Fig. 6 IR Spectrum of Resin Sheet After K-K Analysis

The section below describes the method of determining the absorption coefficient k from the reflectance R of the measured sample obtained from the specular reflectance spectrum.

The complex refractive index of the substance is taken as $n^* = n + ik$ (where, $i^2 = -1$). When the infrared is incident perpendicularly, the refractive index n and absorption coefficient k are given by the following expressions.

Refractive index

$$n = \frac{1 - R}{1 + R - 2\sqrt{R} \cos \phi} \quad \dots\dots(1)$$

Absorption coefficient

$$k = \frac{-2\sqrt{R} \sin \phi}{1 + R - 2\sqrt{R} \cos \phi} \quad \dots\dots(2)$$

Where, ϕ represents the phase difference between the incident light and reflected light. When ϕ is known, the refractive index n and absorption coefficient k can be determined from the expressions above. The value of ϕ corresponding to the wavenumber ν_g is determined using a Kramers-Kronig relationship, as follows:

$$\phi(\nu_g) = \frac{2\nu_g}{\pi} \int_0^\infty \frac{\ln \sqrt{R(\nu)}}{\nu^2 - \nu_g^2} d\nu \quad \dots\dots(3)$$

That is, ϕ is determined from the reflectance R , and this value of ϕ is applied to expression (2) to determine the absorption coefficient k at wavenumber ν_g . Performing this calculation across the entire wavenumber range produces an absorption spectrum.

The Maclaurin method and double fast-Fourier-transform (double FFT) method are typical algorithms used in expression (3). The Maclaurin method offers higher accuracy but double FFT is more commonly used due to its shorter processing times.

Kramers-Kronig (K-K) analysis may result in significant noise and baseline distortion in the measured spectrum. Take due care to acquire an IR spectrum with the minimum noise possible. One effective method is to apply K-K analysis after eliminating the areas of high noise.

Fig. 1 (C) shows an example of the measurement of a polyester film on a glass substrate. Fig. 7 shows the IR spectrum obtained. Interference fringes are apparent. The interference fringes were used to calculate the film thickness.

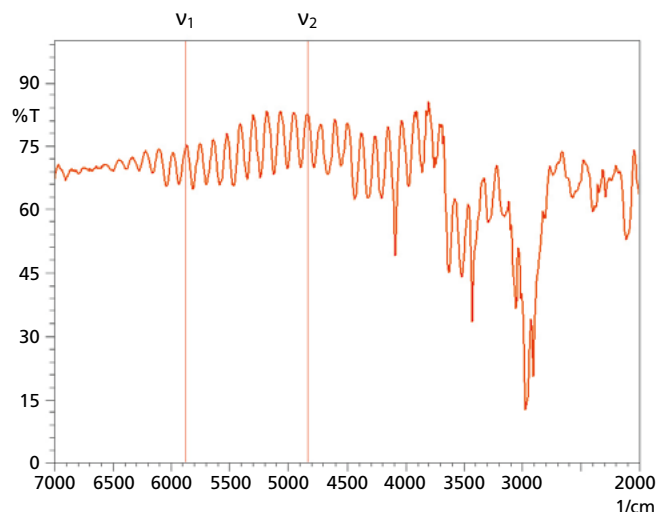

Fig. 7 IR Spectrum of Polyester Film on a Glass Substrate

If the refractive index is denoted n and the angle of incidence is denoted θ , the film thickness d is given by the following expression.

$$d = \frac{\Delta m}{2\sqrt{n^2 - \sin^2 \theta}} \times \frac{1}{(\nu_1 - \nu_2)} \quad \dots\dots(4)$$

Where, ν_1 and ν_2 are two wavenumbers in the interference fringe (normally selected at peaks or troughs) and Δm is the number of waves between ν_1 and ν_2 .

For details about measuring film thickness, refer to FTIR TALK LETTER Vol. 15.

The film thickness was calculated by applying expression (4) to the IR spectrum obtained. A refractive index of 1.65 and angle of incidence of 10° were adopted for this calculation. The results indicate a film thickness of 26.4 μm

5. Absolute Reflectance Measurements

Most specular reflectance measurements by infrared spectroscopy measure the ratio of the sample reflectance to that of a reference mirror. That is, they are relative reflectance measurements.

However, the reflectance of the reference mirror is not 100 % and the reflectance differs from mirror to mirror. Consequently, the measured results differ according to the reference mirror used. The absolute reflectance attachment shown in Fig. 8 is used to accurately measure the reflectance of a sample.

Fig. 9 shows the optical system of the absolute reflectance attachment. Initially, a mirror is positioned at position (a) in Fig. 9 (A) to measure the background (V arrangement). Next, the mirror is moved to position (b) on the symmetrically opposite side of the measured sample face to position (a), as shown in Fig. 9 (B). The sample is then mounted to measure the reflectance (W arrangement). Although the mirror position is changed, the light angle of incidence and optical pathlength are the same for the V arrangement and W arrangement. The infrared light reflected from the sample is then reflected from the mirror and then again from the sample. Since the light reflects from the sample twice, the result produced by the measurements is the square of the sample reflectance. The absolute sample reflectance is determined by taking the square-root of the reflectance spectrum.

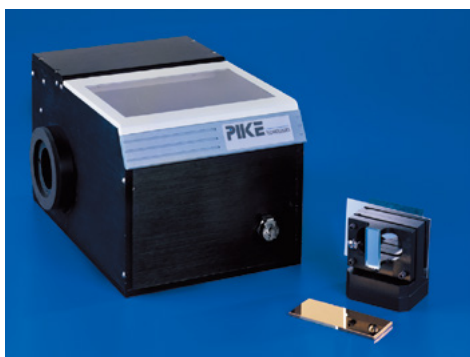

Fig. 8 Appearance of the Absolute Reflectance Attachment

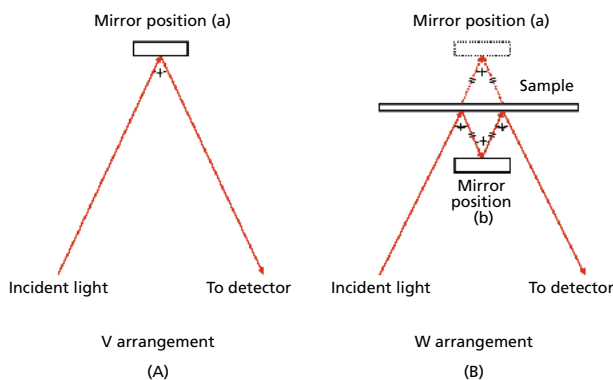

Fig. 9 Absolute Reflectance Attachment Optical System

Fig. 10 shows the measured absolute reflectance for an aluminum mirror and gold mirror. These results indicate an absolute reflectance of each mirror near 2000 cm^{-1} of approximately 96 % for the gold mirror and approximately 95.5 % for the aluminum mirror. This indicates that absolute reflectance measurements are useful for evaluating reflecting samples.

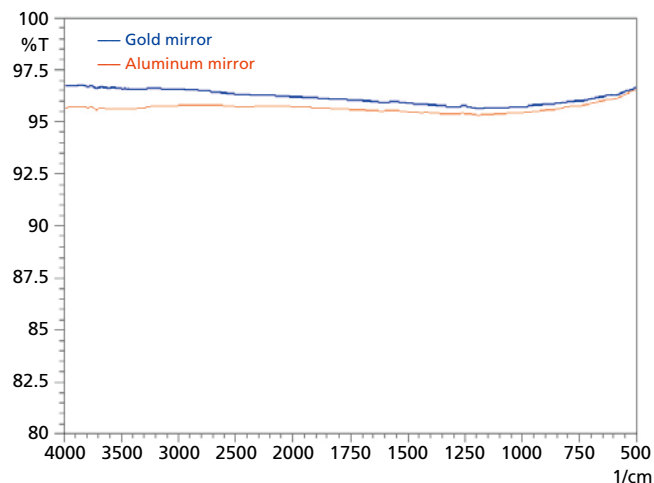

Fig. 10 Absolute Reflectance Spectrum of Aluminum Mirror and Gold Mirror

6. Conclusions

Specular reflectance measurements offer a convenient method to measure flat resin sheets or films on a metal substrate without any pretreatment. They also eliminate the close contact with a prism that is essential for ATR measurements. However, the measured samples are somewhat restricted, as the results are highly dependent on the sample surface state and the film thickness. Refer to FTIR TALK LETTER Vol. 6 for a detailed description of specular reflectance measurements using a microscope.

References

- *Introduction to Spectroscopy Series, Vol. 6 – IR and Raman Spectroscopy*
Edited by the Spectroscopical Society of Japan, Kodansha Ltd.
- *IR Spectroscopy (Instrument Analysis Techniques Series)*
Masayuki Tanaka, Norio Teramae, Kyoritsu Shuppan Co., Ltd.
- *FT-IR Fundamentals and Actualities*
Mitsuo Tasumi, Tokyo Kagaku Dojin
- *NIR Spectroscopy*
Written and edited by Yukihiro Ozaki, Japan Scientific Societies Press

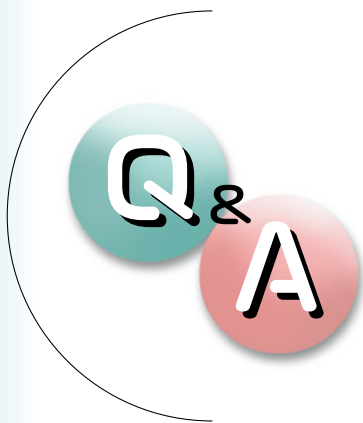

Question

How does Raman spectroscopy differ from infrared spectroscopy?

Answer

Infrared spectroscopy involves shining infrared light onto the sample and measuring the amount of light absorbed at each wavelength (wavenumber). Conversely, Raman spectroscopy measures the light scattered from the sample when light of a certain wavelength is shone onto the sample. The Raman spectrum plots the scattering intensity on the vertical axis and the wavenumber difference between the incident light and scattered light (the so-called Raman shift) on the horizontal axis. The same units as the IR spectrum, cm^{-1} , are used on the horizontal axis. The Raman spectrum is a vibrational spectrum based on the molecular vibrations, in the same way as an IR spectrum. Both methods are used for identification of substances by comparing them with known spectra, for determining molecular structures and for quantitative analysis. However, the detected peak positions, intensities, and shapes differ between each method. Some molecular vibration modes appear in the spectra whereas others do not. Therefore, the manifestation of these modes differs between IR spectroscopy, which is based on absorption, and Raman spectroscopy, which is based on scattering. That is, some vibration modes that do not absorb infrared light cause Raman scattering, or vice-versa. In addition, some modes manifest as both.

This is called the "selection rule."

Fig. 1 shows the IR spectrum and Raman spectrum of polyester. Functional groups such as $>\text{C}=\text{O}$ or $-\text{C}-\text{O}-\text{C}-$ appear strongly in infrared absorption. On the other hand, Raman scattering strongly reveals bonds between similar atoms, such as $\text{C}=\text{C}$. So, the IR spectrum and Raman spectrum provide complementary information. Table 1 summarizes the comparison of Raman spectroscopy and IR spectroscopy.

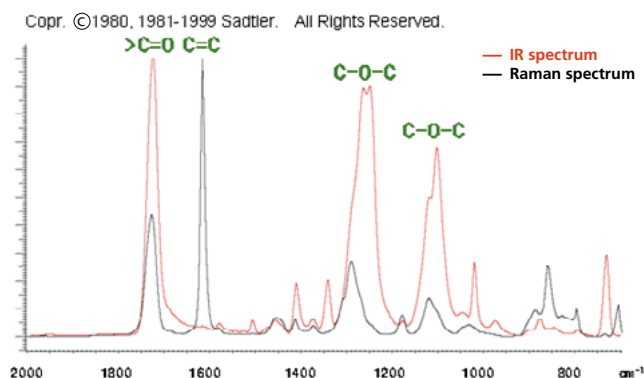

Fig. 1 IR Spectrum and Raman Spectrum of Polyester (Excitation wavelength: 532 nm)
Source: Sadtler Database, Bio-Rad Laboratories, Inc.

Table 1 Comparison of Raman Spectroscopy and IR Spectroscopy

| Raman Spectroscopy | IR Spectroscopy |
|--|--|
| Using a Raman microscope permits measurements of samples to approximately 1 μm . | Using an infrared microscope permits measurements of samples to approximately 10 μm . |
| As glass is transparent to light and Raman scattering, samples can be directly measured in reagent bottles or glass capillaries. | As glass absorbs infrared light, samples cannot be directly measured in reagent bottles or glass capillaries. |
| As Raman spectroscopy is less affected by water than IR spectroscopy, it can be used to measure aqueous solutions. | Due to the high absorption of water in the mid-infrared regions, use for measuring aqueous solutions is restricted. |
| As solid samples can be measured directly, no dilution in a reagent such as KBr is required. | Various measurement methods can be selected to suit the sample shape and concentration, and the aim of the measurement. |
| Few spectrum libraries exist, making substance identification difficult. | Numerous spectrum libraries are available, which makes substance identification easy. |
| Instrument is expensive. | Instrument is cheap. |
| The high intensity of the laser light can damage the sample during measurements. | The energetically weak electromagnetic waves of the infrared light cause almost no damage to the sample during measurements. |

 : Advantage : Disadvantage

UV-VIS Spectrophotometers

UV-2600/2700

Experience the Precision Desired,
in Any Situation



Single monochromator UV-2600

Capable of a Measurement Wavelength up to 1400 nm

Equipped with a single monochromator, providing low noise performance across a wide wavelength range
Enables near-infrared measurements (up to 1400 nm)*

* When the optional ISR-2600Plus integrating sphere is used

Even More Compact and User-Friendly

A compact 450 mm width size, reducing the required installation space by 28 %*
Achieves 10 %* energy savings compared to other Shimadzu systems

* In comparison to the older UV-2450/2550 models
Validation software is included as standard

Double monochromator UV-2700

Performance with a Minimum 8-Abs Photometric Range

Equipped with an ultra-low stray light double monochromator, capable of 8-Abs measurements
Uses the Shimadzu proprietary Lo-Ray-Ligh grade diffraction grating

With a Wealth of Accessories, Accommodates Every Application

Freely expandable to suit the measurement objective
Existing system accessories can also be used
Automated data processing



For Research Use Only. Not for use in diagnostic procedures.

This publication may contain references to products that are not available in your country. Please contact us to check the availability of these products in your country.

Company names, products/service names and logos used in this publication are trademarks and trade names of Shimadzu Corporation, its subsidiaries or its affiliates, whether or not they are used with trademark symbol "TM" or "®".
Third-party trademarks and trade names may be used in this publication to refer to either the entities or their products/services, whether or not they are used with trademark symbol "TM" or "®".
Shimadzu disclaims any proprietary interest in trademarks and trade names other than its own.

The contents of this publication are provided to you "as is" without warranty of any kind, and are subject to change without notice. Shimadzu does not assume any responsibility or liability for any damage, whether direct or indirect, relating to the use of this publication.

Shimadzu Corporation

www.shimadzu.com/an/