

Agilent Vials and Sample Containment Solutions

Your essential resource for autosampler vial selection

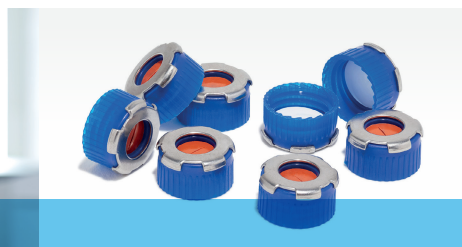
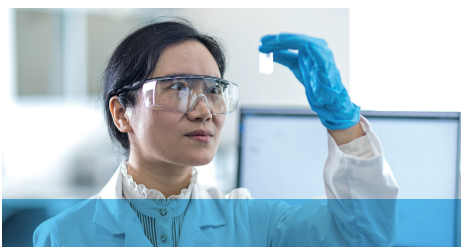

Table of Contents

Proven Value	3	Containment Solutions for Sample Volumes of 2 mL	22
Agilent Certified vials	4	Vials	22
Agilent A-Line vials	5	Crimp caps	23
		Screw caps	24
		Snap caps	25
		Convenience packs	26
		Pre-assembled packs	26
		Vial kits	27
Vial Selection	6	Containment Solutions for Sample Volumes (>2 mL)	28
Agilent Vials Compatibility Chart	6	Vials, caps, kits, and septa for 4 mL volumes	28
Sample size	13	Vials, caps, septa, and seals for >4-10 mL volumes	28
Component options	13	Headspace vials	29
Closures	14	Headspace caps	30
Compatibility of septa and sample	14	Headspace septa and stoppers	30
Compatibility of septa and cap	15	Headspace kits	31
Crimp cap vs. screw cap	15	LC high recovery vials	31
Where to measure to match the vial size with its cap	16	Purge and trap vials, caps, and septa	31
Specialized Applications	17	Storage vials	31
Deactivated vials	17	Bonded caps	32
Polypropylene vials	17	Test tubes	32
Ordering Information	18	Accessories	33
Containment Solutions for Sample Volumes (<2 mL)	19	Agilent CrossLab	35
Vials	19		
Inserts	20		
Well plates	21		
Mats	21		

It's more than just a vial, it can affect your results and return on instrument investment

It's easy to think of vials as simple, inexpensive components that don't affect your results. However, substandard vials, caps, and septa can lead to sample loss, contamination, and damaged autosampler needles.

Agilent understands that vials are a critical part of your analytical workflow—no less important than the column or the instrument. This is why Agilent vials are designed to meet the high standards you expect from every Agilent product. These standards include:

- Consistent lot-to-lot performance
- Rigorous quality control and manufacturing
- Better value for your money
- Easy selection based on volume, sample type, and instrument

Stop unexpected peaks from impacting your results

Sometimes, vials measure the indirect effects of the analytical flow path instead of the sample. With Agilent vials, you know that only your sample is being measured, nothing else.

Agilent offers a comprehensive solution for getting your samples from injection to detection with minimal interference to maximize your productivity.

Facts and Figures

Only Agilent vials have these quality and performance statistics

30%

time savings

Save time using our full range of short-thread screw top vials and caps.

\$0

for technical support

Unlike some other suppliers, Agilent does not charge you for technical support.

50%

faster crimp speed

Our electric crimper lets you crimp your vial quickly and efficiently.

30+

inspection points

So you get the tightest dimensional specifications, every time.

10+

compatible brands

Agilent vials/caps are compatibility tested with over 10 instrument brands.

Up to

\$100K

saved annually

by a number of customers, using Agilent technical support and recommended vials.

33/51

best in glass

All vials are made of type 33-51 coefficient of expansion for top performance.

25%

cost savings

Save up to 25% in operating costs with A-Line vials.



Save money, and eliminate drains on your lab's productivity

Why gamble with your results?

Using poor-quality vials (or the wrong vials for your application) can cause sequencing problems, unnecessary downtime, expensive repairs, and the loss of precious samples

Agilent vials are reliable and consistent, saving time and money.

- **Reduced labor:** Our short-thread screw top vials make screwing/unscrewing caps up to 30% faster.
- **Less interference:** Agilent vials are made from analytical grades 33 and 51 glass, which will not remove analytes from sample matrices.
- **Fewer septa issues:** Agilent septa are continually being improved to limit leaching, coring, sticking, push-through, hardness, and adsorption/absorption.
- **Lower risk of breakage:** Thicker glass walls help eliminate cracking during clamping, and a unique packing box keeps vials safe during transit and storage.
- **Fast delivery and easy ordering:** Everything you need from one trusted supplier, with worldwide distribution centers so your vial order reaches your lab within 48 hours.
- **Free 24/7 technical support:** Our team is always available to provide fast, expert assistance, should any issues arise.



Certified integrity and consistency

Agilent Certified Vials are produced in an ISO 9001 certified environment and packaged to reduce contamination. Our vials are pierce tested with Agilent needles and syringes, inspected with automated vision systems, and compatible with autosampler gripping and injection mechanisms.

Agilent A-Line vials

The trusted choice for your precious samples and high-precision analyses

- **Save time:** Dramatically reduce the number of sample reruns.
- **Get higher throughput:** Surface inertness reduces peak response variability for more accurate results and less rework.
- **Attain consistent recoveries:** Be confident you're getting the most precise and consistent measurement from vial-to-vial, lot-to-lot, and over time, of low-level analytes.
- **Spend less:** Save up to **25%** on your laboratory spend by significantly reducing unplanned costs (such as troubleshooting, reruns, and downtime).
- **Conform with demanding and regulated environments:** Our Certificate of Analysis provides specific data confirming vial appropriateness.



Tips and tools

See our case study video on cost reducing:
www.agilent.com/chem/switch-vials-video

Agilent A-Line vials: Better analyte retention over time

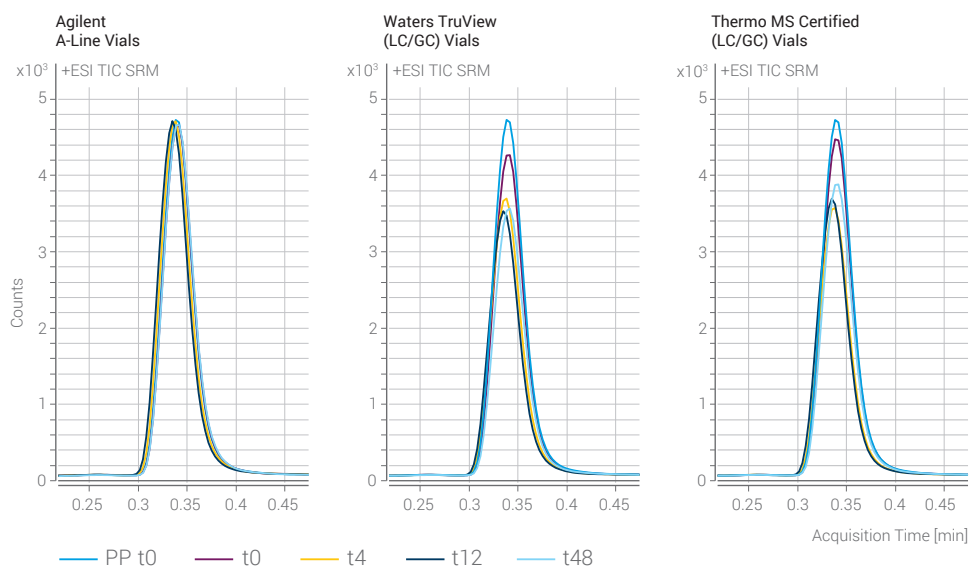

The Agilent A-Line vial shows superior analyte retention in this separation of doxepin.

Note: Tests were carried out by Agilent.

For more information on the comparison data, you can download the study at

www.agilent.com/chem/a-line-vials-poster

Vials Compatibility Chart for Major Worldwide Brands

This is a simplified breakdown of various major branded autosamplers, including legacy and current models. This chart is accurate as of June 2022. Newer autosampler models may be available and some legacy models may no longer be supported after this date.

For a newer, online version, which is updated every three to six months, please visit: <http://www.agilent.com/chem/vial-compatibility>

Manufacturer	Model	Crimp	Snap	Screw				Headspace				VOA
				8	9	10	13	23	23	23	23	
	Vial Septum Seat Diameter (mm)	11	11	8	9	10	13	23	23	23	23	28
	Vial Size (mL)	2	2	2	2	2	4	10	20	10 & 20	10 & 20	20 & 40
	Vial Thread Style			8-425	9-425	10-425	13-425					24-400
	Bottom (FB – Flat Bottom, RB – Round Bottom)	FB	FB	FB	FB	FB	FB	RB	RB	RB	FB	FB
Agilent	8035			•	•							
	1090, 1100, 1200	•	•		•							
	1260, 1290 Infinity	•			•							
	5880, 5890, 6850 (27 position tray), 6890	•			•							
	6850 (22 position tray)						•					
	7673A, 7683A	•			•							
	7693A	•	•	•			•					
	7695A											•
	7697A										•	
	7985A	•	•		•							
	8000, 8100, 8200*, 8400, CP-910 to 912	•		•	•	•*						
	920-LC/940-LC		•	•								
	AQUATek 70											•
	Archon purge and trap											•
	COMBI PAL SPME mode (32 position tray)							•		•		

*Specific models are only compatible with certain screw or headspace vial types. Model 8200 is only compatible with the screw format indicated by the asterisk (10 mm, 2 mL, 10-425, FB).

(continued)

Did you know?

Don't have an Agilent instrument? No problem.

Agilent vials perform seamlessly with many analytical instruments. Use the Vials Compatibility Chart to determine which Agilent vials are compatible with your instrument manufacturer and model.

Did you know: 2 mL high-recovery screw top vials can be used with all autosamplers.

Manufacturer	Model	Crimp	Snap	Screw				Headspace				VOA
	Vial Septum Seat Diameter (mm)	11	11	8	9	10	13	23	23	23	23	28
	Vial Size (mL)	2	2	2	2	2	4	10	20	10 & 20	10 & 20	20 & 40
	Vial Thread Style			8-425	9-425	10-425	13-425					24-400
	Bottom (FB – Flat Bottom, RB – Round Bottom)	FB	FB	FB	FB	FB	FB	RB	RB	RB	FB	FB
Agilent	COMBI PAL SPME mode (98 position tray)	●			●			●				
	COMBI PAL (200 position tray) GC PAL (200 position tray)							●				
	COMBI PAL (32 position tray) GC PAL (32 position tray)							●		●		
	COMBI PAL (98 position tray) GC PAL (98 position tray)	●			●			●				
	CP-9010	●		●	●							
	CP-9020/CP-9025/ CP-9060							●				
	CP-940, 941	●										
	CTC COMBI PAL							●		●		
	CTC GC PAL	●			●							
	CTC HTS+HTC PAL	●	●		●							
	G1888A						●					●
	Genesis	●										●
	GPC 110/210/220	●		●	●	●						
	HS7694						●					●
	LC 9100/LC 9095/ LC 9090	●	●		●							
	Marathon basic, standard, 96 position	●	●	●	●							
	PL-AS RT	●	●	●	●	●	●					
	ProStar 400, standard, 96 position tray	●	●	●	●	●						
	ProStar 410, large capacity, 96 position tray	●	●	●	●	●						

(continued)

Learn more

From instruments to columns and supplies, find everything you need from one trusted supplier. Better injections, better chromatography.

No matter what your sample introduction needs are, Agilent has a sampler to support your lab's productivity.

For Agilent GC autosamplers, visit www.agilent.com/chem/GCsampleintro

For Agilent LC autosamplers, visit www.agilent.com/chem/lc-injection-system

Vial Selection

Manufacturer	Model	Crimp	Snap	Screw				Headspace				VOA
	Vial Septum Seat Diameter (mm)	11	11	8	9	10	13	23	23	23	23	28
	Vial Size (mL)	2	2	2	2	2	4	10	20	10 & 20	10 & 20	20 & 40
	Vial Thread Style			8-425	9-425	10-425	13-425					24-400
	Bottom (FB – Flat Bottom, RB – Round Bottom)	FB	FB	FB	FB	FB	FB	RB	RB	RB	FB	FB
Agilent	ProStar 410, large volume, 24 position tray							•				
	ProStar 410, standard, 84 position tray	•	•	•	•	•		•				
	ProStar 420, LSV, 72 position tray						•					
	ProStar 420, standard, 96 position tray	•	•	•	•	•						
	ProStar 420, Super-LSV, 32 position tray							•				
	ProStar 430, 48 position tray	•	•	•	•							
	Tekmar SOLATEk72											•
	Vista			•	•							
Beckman Coulter	501, 502, 507	•	•	•	•	•						
	508				•			•				
	Marathon, Promis	•	•	•	•							
	Triathlon	•	•	•	•		•	•				
Bruker	LC51						•					
	Map II	•		•	•	•						
CTC	A200 LC	•	•	•	•	•		•				
	A200S	•		•	•	•						
	Combi-xt (L-mode), GC-xt Headspace, PAL HPLC-Systems, HTS-xt, HTX-xt, PAL	•		•	•	•		•		•		
	Combi-xt Headspace, Combi-xt SPME Option	•						•		•		
	HS 500							•				
DANI	ALS 39.80, 86.80, 1000	•	•		•							
	HS39.50, HS86.50										•	
	Master AS	•	•		•						•	
GE Instruments	Sievers 900										•	
GERSTEL	MPS 2**, 3	•		•	•	•		•**		•**		

**Specific models are only compatible with certain screw or headspace vial types. Model MPS 2 is only compatible with the headspace formats indicated by the asterisk (23 mm, 10 mL, RB and 23 mm, 10 and 20 mL, 23 x 75 mm, RB).

(continued)

Manufacturer	Model	Crimp	Snap	Screw				Headspace				VOA
	Vial Septum Seat Diameter (mm)	11	11	8	9	10	13	23	23	23	23	28
	Vial Size (mL)	2	2	2	2	2	4	10	20	10 & 20	10 & 20	20 & 40
	Vial Thread Style			8-425	9-425	10-425	13-425					24-400
	Bottom (FB – Flat Bottom, RB – Round Bottom)	FB	FB	FB	FB	FB	FB	RB	RB	RB	FB	FB
Gilson	201/202, 221/222, 231/401, 232/402, Aspec, AspecXli, Aspec XL 4, 235/235P/SP 235/ SP 235P			•	•							
	234, 235, 215, 250, 231XL/232X- L/233XL	•		•	•							
JASCO	AS 2055/AS 2055 (i), v AS 2057/AS 2057 (i), AS 2059	•	•	•	•	•						
LEAP Technologies	Combi PAL (32 position)							•		•		
	Combi PAL (98 position), SPME (98 position)	•			•							
	Combi PAL SPME Mode (32 position)									•		
	HTX PAL, HTC PAL, HTS PAL (32 position)									•		
	LC PAL (216 Pos.), HTX PAL, HTC PAL, HTS PAL (54/98 position tray)	•	•	•	•	•		•				
O.I. Analytical	1020A,1088,1096,4551A,1552											•
PerkinElmer	AI-1, AS-100/(B), AS300, AS8300	•										
	Clarus 400, 500, 600	•										
	HS40/HS100/101								•			
	Integral 4000, ISS	•					•					
	Series 200 vial tray, AS2000/AS2000B	•					•					
	TurboMatrix HS16/ HS40/HS40 XL/ HS40 Trap/HS110/ HS110 Trap								•		•	
Shimadzu	AOC-14/1400	•	•	•	•	•	•	•				
	AOC-17	•	•	•	•	•	•					
	AOC-20/20i/20s, 96 position tray						•					
	AOC-20/20i/20s, 150 position tray	•		•	•	•	•					
	AOC-5000	•			•			•		•		
	ASI-V											•
	HSS-2B						•			•	•	
	HTA 200 H									•	•	

(continued)

Vial Selection

Manufacturer	Model	Crimp	Snap	Screw				Headspace				VOA
	Vial Septum Seat Diameter (mm)	11	11	8	9	10	13	23	23	23	23	28
	Vial Size (mL)	2	2	2	2	2	4	10	20	10 & 20	10 & 20	20 & 40
	Vial Thread Style			8-425	9-425	10-425	13-425					24-400
	Bottom (FB – Flat Bottom, RB – Round Bottom)	FB	FB	FB	FB	FB	FB	RB	RB	RB	FB	FB
Shimadzu	LC2010C + LC2010A, 100 position tray						•					
	LC2010C + LC2010A, 140 position tray	•	•	•	•	•						
	LC2010C + LC2010A, 350 position tray											
	LC-20A, SIL-2AS, SIL-6A, -6B, -7A, -8A, -9A	•	•	•	•	•	•					
	SIL 30-ACMP	•		•	•							
	SIL-10A/SIL-10AF/SIL-10AP/ SIL-10Ai/SIL-10AxL/Rack L, 80 position						•					
	SIL-10A/SIL-10AF/SIL-10AP/ SIL-10Ai/SIL-10AxL/Rack S, 100 position	•	•	•	•	•						
	SIL-10A/SIL-10AF/ SIL-10AP/ SIL-10Ai/SIL-10AxL/Rack MTP2, 192 position											
	SIL-10ADvp	•	•	•	•	•	•					
	SIL-10HTA/SIL-10HTC, 100 position tray						•					
	SIL-10HTA/SIL-10HTC, 350 position tray											
	SIL-10HTA/SIL-10HTC, 140 position tray	•	•	•	•	•						
	SIL-20A (Prominence) 105 vial tray/ SIL-20AC (Prominence), 70 vial tray	•	•	•	•	•						
	SIL-20A/Sil-20AC (Prominence), 175 vial tray											
	SIL-20A/Sil-20AC (Prominence), 50 vial tray						•					
	SIL-20AXR/SIL-20ACXR (Prominence), 175 (1 mL vials), 70 (1.5 mL vials), 50 (4 mL vials)	•	•	•	•	•	•					
	SIL-30AC (Nexera), 175 (1 mL vials), 105 (1.5 mL vials), 50 (4 mL vials)	•	•	•	•	•	•					

(continued)

Manufacturer	Model	Crimp	Snap	Screw				Headspace				VOA
	Vial Septum Seat Diameter (mm)	11	11	8	9	10	13	23	23	23	23	28
	Vial Size (mL)	2	2	2	2	2	4	10	20	10 & 20	10 & 20	20 & 40
	Vial Thread Style			8-425	9-425	10-425	13-425					24-400
	Bottom (FB – Flat Bottom, RB – Round Bottom)	FB	FB	FB	FB	FB	FB	RB	RB	RB	FB	FB
Teledyne Tekmar	7000/7000HT/7050								●			
	AQUATek 70/ SOLATek 72											●
	HT3								●	●		
	STS 8000 TOC											●
Thermo Fisher Scientific	Accela High Speed LC Autosampler (200 position)	●	●	●	●							
	Accela Open Autosampler	●	●		●							
	AS 40						●					
	AS 50		●	●	●	●						
	AS100	●	●	●	●							
	AS1000,200	●		●	●							
	AS2000 90 vial tray (Trace GC), 200S, AS800	●		●	●							
	AS300, A200LC, SpectraSystem AS 100-3500	●	●	●	●							
	ASE 200											●
	Dionex AS 40						●					
	Dionex AS-AP	●	●	●	●	●						
	Dionex UltiMate WPS-3000	●	●	●	●	●	●					
	Gina 50	●	●		●		●					
	HiPerTOC											●
HS250-500							●					

(continued)

Tips and tools

Here's why "bargain" vials are not much of a bargain

Bargain vials can be made from type 70 or 71 COE glass, which has high metal content that can remove analytes or destabilize the analyte through alkyl leaching. Agilent vials are made from type 33 and 51 glass so you can be confident that your results will not be compromised.

To learn more about glass quality, download our free white paper at www.agilent.com/chem/vialsresources

Vial glass types

ASTM E438 Type I Class A Linear COE	ASTM E438 Type I Class B Linear COE
32 – 33 (+/- 1.5)	48 – 56 (+/- 2.0)

Coefficient of expansion (COE) compliance – 0 to 300 °C, cm/cm x C x 10⁻⁷ (acceptable expansions for analytical chromatographic purposes).

Vial Selection

Manufacturer	Model	Crimp	Snap	Screw				Headspace				VOA
	Vial Septum Seat Diameter (mm)	11	11	8	9	10	13	23	23	23	23	28
	Vial Size (mL)	2	2	2	2	2	4	10	20	10 & 20	10 & 20	20 & 40
	Vial Thread Style			8-425	9-425	10-425	13-425					24-400
	Bottom (FB – Flat Bottom, RB – Round Bottom)	FB	FB	FB	FB	FB	FB	RB	RB	RB	FB	FB
Thermo Fisher Scientific	HS800-2000							•		•		
	HS-HV			•								
	Summit ASI 100, Analytical Tray (117 position), Summit ASI 100, Semipreparative tray (63 position)	•	•	•	•		•					
	Surveyor (Surveyor Plus)	•	•	•	•			•				
	Trace 1300 Series	•	•	•	•	•			•		•	
	TriPlus (=GC PAL) (AS+ Duo)	•		•	•			•		•		
	TriPlus 300									•		
	TriPlus HS, SPME							•		•		
	TriPlus RSH	•	•	•	•			•		•		
	UltiMate Analytical, WPS 3000sl, 120 position (2 mL), FAMOS (LC Packings–Dionex)	•	•	•	•	•			•			
UltiMate Nano/Cap/Micro, WPS-3000 SL, 216 (3 x 72) position rack (1.2 mL)								•				
UltiMate Semipreparative, WPS-3000 SL, 66 (3 x 22) position rack (4 mL)							•	•				

Need more information?

Make productivity happen, regardless of application or instrument vendor.

Improve cycle time, eliminate variability, and enhance your results at every step of your workflow.

For information on GC, GC/MS, or GC headspace, visit www.agilent.com/chem/productivityGC

To view our GC flow path supplies, visit www.agilent.com/chem/inert

For LC and LC/MS products, visit www.agilent.com/chem/productivityLC

Protect sample integrity by choosing the best vial for your application

By matching our vials to your application, you can contain samples with minimal interference from the surrounding environment, and ensure optimal sample interface with your analytical platform. To help you get started, we've answered the most common questions about vial selection below.

Which vial is best for my sample size?

There are several factors to consider, including analysis type, analytical platform, and sample availability. Agilent vials offer the same highly consistent performance across the entire size range, from 15 μL to 60 mL. Use the diagram below as a starting point for choosing the size you need based on your sample volume.

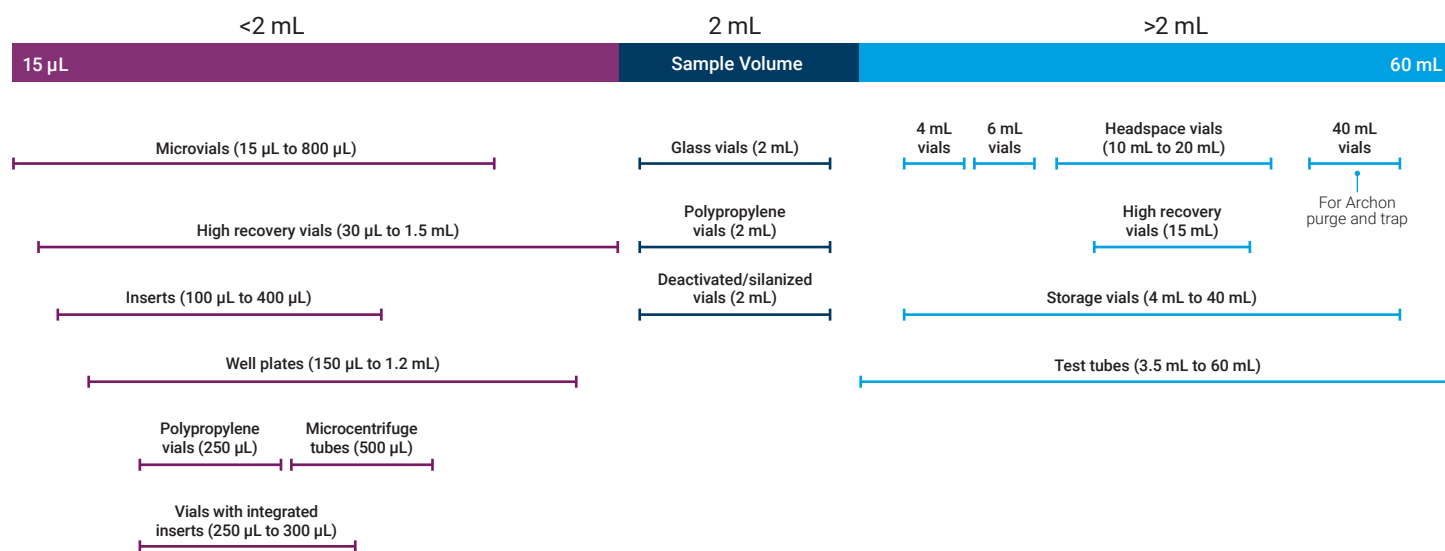

How do vial components factor in?

Vial caps, septum, and inserts prevent leakage and sample loss due to evaporation. Like Agilent vials, Agilent vial components receive the same high level of attention during design and manufacture. They also work seamlessly with Agilent vials so that complex runs proceed smoothly.

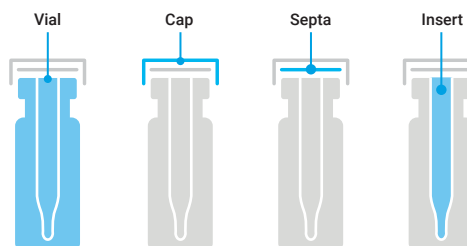

How do I choose the right closure?

There are three major factors to consider when selecting a closure.

Compatibility of septa and sample

Make sure the septa you choose are chemically compatible with your sample and solvent. Chemical compatibility can vary, based on factors such as solvent concentration, molecular weight, and temperature.

During manufacture, Agilent septa undergo thermal and chemical conditioning to reduce siloxane bleed, which can occur when the septa material is stressed during heating, solvent interaction, or piercing by the autosampler needle.

Septa Chemical Compatibility

	PTFE	PTFE/Silicone	PTFE/Silicone/PTFE*	PTFE/Red Rubber	Fluoroelastomer	PTFE/Butyl
Acetonitrile	●	●	●	●		●
Hydrocarbons (hexane, heptane, methane)	●		●	●	●	
Methanol	●	●	●	●		●
Benzene	●		●		●	
THF	●		●			
Toluene	●		●			
DMF	●	●	●			●
DMSO	●	●	●			●
Ether	●	●	●			
Chlorinated solvents (methylene chloride)	●		●		●	
Alcohols (ethanol)	●	●	●	●	●	●
Acetic acid	●	●	●			●
Acetone	●	●	●			
Phenol	●	●	●		●	●
Cyclohexane	●		●	●	●	

*PTFE/silicone/PTFE has the same chemical compatibility of PTFE only until punctured.



5183-4496



5183-4437

Tips and tools

For highly sensitive samples, we recommend PTFE-lined (“sandwiched”) septa, because the PTFE layers act as a chemically resistant barrier.

Compatibility of septa and cap

Use the chart below to determine the right cap and septa combination, based on your application.

Note: septa that are too thick can prevent the cap from fitting properly on the vial.

If siloxane interference is a concern for your application, we recommend Agilent Certified caps and Agilent Certified bonded caps. They provide the industry's lowest bleed profile for better analytical sensitivity, reduced downtime, and improved productivity.

Cap and Septa Compatibility

	High Performance Septa	Thin PTFE	PTFE/Silicone*	PTFE/Silicone/PTFE*	PTFE/Red Rubber	Fluoroelastomer	Butyl
Temperature range	40 to 300 °C**	Up to 260 °C	-40 to 200 °C	-40 to 200 °C	-40 to 90 °C	-40 to 260 °C	-50 to 150 °C
Use for multiple injections	No	No	Yes	Yes	No	No	No
Price	Most expensive	Very economical	Economical	Most expensive	Very economical	Economical	Economical
Resistance to coring	Excellent	None	Excellent	Excellent	None	None	None
Recommended for storage	No	No	Yes	Yes	No	No	No
Best for	High temperature headspace applications	Superior chemical inertness, short cycle times, and single injections	Most common HPLC and GC analyses, not as resistant to coring as P/S/P	Superior performance for ultra trace analyses, repeat injections, internal standards	Chlorosilanes, more economical option for single injections	Chlorinated solvents, higher temperatures	Organic solvents, acetic acids, impermeable to gasses

*Agilent silicone is peroxide-cured, making it more inert and less likely to interact with samples.

**For up to one hour

Crimp cap vs. screw cap

Based on decades of chromatography experience, we have found that crimp cap vials tend to be best for GC and GC/MS applications, while screw cap vials are generally used for LC and LC/MS applications. However, your specific application—as well as your personal preference—are also factors to consider.

Although both types of caps deliver a good seal, crimp caps provide extra security for food, forensics, and other applications where sample tethering needs to be avoided. We also recommend a screw cap vial if you are working with volatile compounds.



5188-5386



5190-3986



5182-0552

Vial Selection

Where to measure to match the vial size with its cap

Determine the right vials and caps for your needs. The table, with corresponding diagrams, shows where to take the measurement.

Vial and Closure Dimensions

Cap Type	Septum (Diameter)	Vial Closure (Septum Seat Diameter)	Vial Closure (od)	Vial Closure (Opening id)	Comments
2 mL (wide opening)					
Screw	9 mm	9 mm	12 mm	6 mm	
Crimp	11 mm	11 mm	11 mm	6 mm	Closure od and septum seat diameter are very close since the crimp cap wall is thin. After rounding, they are both 11 mm.
Snap	11 mm	11 mm	12 mm	6 mm	
2 mL (short opening)					
Screw	8 mm	8 mm	12 mm	5 mm	Closure od is measured at the flared base.
20 mm Headspace					
Crimp	20 mm	20 mm	21 mm	9 mm	The septum has a larger od than the septum seat diameter to provide a snug fit. This prevents septum loosening.
20 mm Headspace					
Screw	18 mm	18 mm	19 mm	8 mm	Closure od is measured at the flared base.

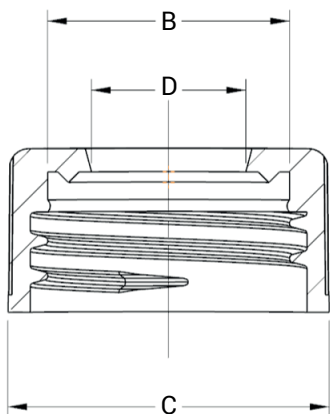

Closure when adjoined to screw top vial.
 B = Septa seat diameter
 C = Cap body diameter (vial closure od)
 D = Cap opening id (vial closure opening id)

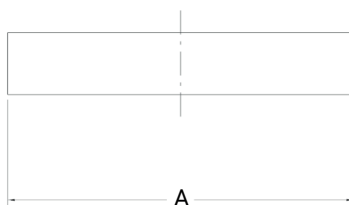

Septum only.
 A = Septum diameter

What about more specialized applications?



5183-4496

Deactivated vials

For pesticides, semivolatiles, and other highly sensitive samples—as well as samples that are prone to sudden pH shifts—deactivated vials are best, because their surface is more hydrophobic and inert.

We also recommend deactivated vials for exacting applications, such as mass spectrometry, to prevent sample interactions before analysis.



5191-8150

Polypropylene vials

Polypropylene vials are an excellent choice for biological and PFAS applications, and for applications involving samples with high metal content—such as ion chromatography, AA, or ICP-MS.

Agilent thoroughly tests and evaluates various polypropylene materials before selecting the grade used in our polypropylene vials. Our vials have the lowest levels of extractables to ensure sample integrity.

Need more information?

Hundreds of choices, one easy guide

Use our online selection tool to quickly find the right products for complete confidence in your sample containment.

- Answer a few simple questions to identify your best options
- Search by technique, product number, or vial type
- Choose from over 600 vials, caps, and septa

Go to www.agilent.com/chem/selectvials

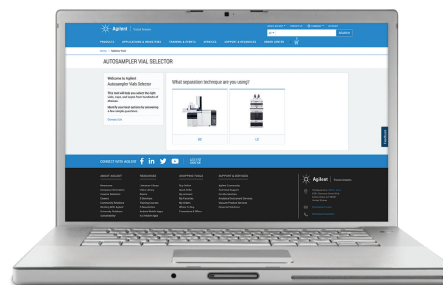

Find the Right Products for Complete Confidence in Your Sample Containment

Agilent vials, caps, and septa have been engineered and designed with the same high quality we build into Agilent instruments. When you put our 40 years of innovation and excellence into your vials and caps, you can have complete confidence in your results.

Inserts for narrow opening vials (8 mm)

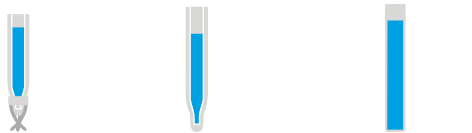

Dimensions:	28 x 4.8 mm	31 x 4.8 mm	31 x 4.8 mm
Recommended fill:	150 µL	150 µL	200 µL
Part number:	5183-2088	5183-2089	5183-2090

Inserts for wide opening vials (11 mm and 9 mm)

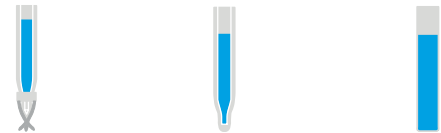

Dimensions:	30 x 5.6 mm	31 x 5.6 mm	31 x 5.6 mm
Recommended fill:	250 µL	250 µL	400 µL
Part number:	5181-1270	5183-2085	5181-3377

Polypropylene vials with crimp/snap top

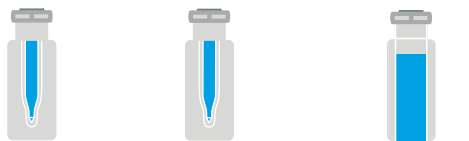

Dimensions:	32 x 12 mm	32 x 12 mm	32 x 12 mm
Recommended fill:	250 µL	250 µL	700 µL
Part number:	5188-2788	9301-0977 Glass insert	5182-0567

Polypropylene vials with screw top

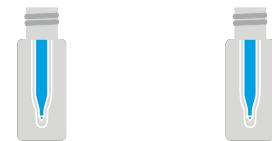

Dimensions:	32 x 12 mm	32 x 12 mm
Recommended fill:	250 µL	250 µL
Part number:	5190-2242	5188-5390 Glass insert

Wide opening screw top vials (9 mm)



Dimensions:	32 x 12 mm	32 x 12 mm	32 x 12 mm	32 x 12 mm
Recommended fill:	250 µL	1.2 mL	1.3 mL	1.5 mL
Part number:	5188-6591	5183-2030	5184-3550	5182-0714

Narrow opening screw top vials (8 mm)



Dimensions:	32 x 12 mm
Recommended fill:	1.5 mL
Part number:	5183-4428

Wide opening crimp top vials (11 mm)



Dimensions:	32 x 12 mm	32 x 12 mm	32 x 12 mm	32 x 12 mm
Recommended fill:	250 µL	1.2 mL	1.3 mL	1.5 mL
Part number:	9301-1388	5182-3454	5184-3551	5181-3375

Large volume vials



Dimensions:	45 x 15 mm	37 x 22 mm	37 x 22 mm
Recommended fill:	4 mL	6 mL	6 mL
Part number:	5183-4448	9301-1377	9301-1419

Headspace vials

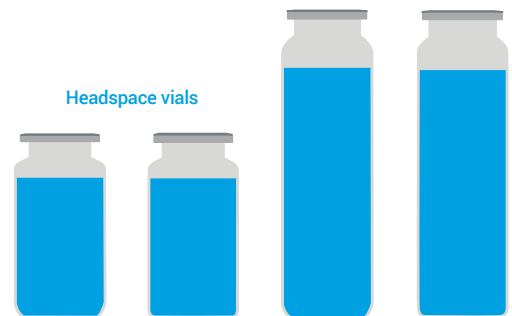

Dimensions:	45 x 22 mm	45 x 22 mm	75 x 22 mm	75 x 22 mm
Recommended fill:	10 mL	10 mL	20 mL	20 mL
Part number:	5183-4475	5182-0838	5183-4474	5182-0837

This is a selection of vials, not the entire portfolio.

Containment Solutions for Sample Volumes (<2 mL)

Vials

Description	Sample Volume	Material	Certified	Unit	Part No.
Microvials					
Wine-glass shape, screw top, 12 x 32 mm	15 µL	Glass, clear		100/pk	5184-3550
	15 µL	Glass, amber		100/pk	5184-3554
Wine-glass shape, crimp top, 12 x 32 mm	15 µL	Glass, clear		100/pk	5184-3551
	15 µL	Glass, amber		100/pk	5184-3555
Crimp top, tapered, 6 mm	100 µL	Glass, clear		500/pk	5180-0844
Crimp top, round bottom, 6 mm, for HTS and HTC PAL liquid injection	300 µL	Glass, clear		500/pk	5180-0841
Crimp/snap top	700 µL	Polypropylene		100/pk	5182-0567
High recovery vials					
Crimp top	1.5 mL with 30 µL reservoir	Glass, clear		100/pk	5182-3454
	1.5 mL with 30 µL reservoir	Glass, clear (silanized)		100/pk	5183-4497
Screw top	1.5 mL with 30 µL reservoir	Glass, clear		100/pk	5183-2030
	1.5 mL with 30 µL reservoir	Glass, amber		100/pk	5183-2073
Microcentrifuge					
Microcentrifuge tubes	500 µL			100/pk	9301-6384
Polypropylene vials					
Crimp/snap top	250 µL	Polypropylene	Y	100/pk	5188-2788
	250 µL	Polypropylene		1,000/pk	5190-3155
Screw top	250 µL	Polypropylene	Y	100/pk	5190-2242
	250 µL	Polypropylene	Y	1,000/pk	5190-2243
	1 mL	Polypropylene		100/pk	5191-8150
Vials with integrated inserts					
Screw top, with glass insert	250 µL	Polypropylene		100/pk	5188-5390
Crimp/snap top, with glass insert	250 µL	Polypropylene		100/pk	9301-0977
	250 µL	Polypropylene	Y	100/pk	9301-0978
Screw top, with fixed insert	300 µL	Glass, clear		100/pk	5188-6591
Crimp top, with fixed insert	300 µL	Glass, clear		100/pk	9301-1388
Screw top, with fixed insert	300 µL	Glass, amber		100/pk	5188-6592
Crimp top, with fixed insert	300 µL	Glass, amber		100/pk	5188-6572



5191-8150

Ordering Information

Inserts

Description	Sample Volume	Material	Certified	Unit	Part No.
Vial insert	100 μ L		Y	500/pk	9301-1387
Vial insert, for 2 mL standard opening (8 mm) screw top vials	150 μ L	Glass with polymer feet		100/pk	5183-2088
Vial insert, 200 μ L measured fill (150 μ L recommended), for 2 mL standard opening (8 mm) screw top vials	150 μ L	Pulled point glass		100/pk	5183-2089
Vial insert, flat bottom, for 2 mL standard opening (8 mm) screw top vials	200 μ L	Glass		100/pk	5183-2090
Vial insert, with graduations	250 μ L	Polypropylene		100/pk	5190-4073
Vial insert	250 μ L	Glass with polymer feet	Y	100/pk	5181-1270
Vial insert	250 μ L	Deactivated glass with polymer feet	Y	100/pk	5181-8872
Vial insert, graduated to 300 μ L in increments of 100 μ L. Do not fill to more than 250 μ L	250 μ L	Polypropylene with polymer feet	Y	100/pk	5182-0549
Vial insert	250 μ L	Pulled point glass	Y	100/pk	5183-2085
Vial insert, conical	250 μ L	Polymer feet	Y	25,000/pk	5185-5958
Vial insert, flat bottom	250 μ L	Glass	Y	50,000/pk	5067-0212
Vial insert	350 μ L	Glass		1,000/pk	5188-5321
Vial insert, flat bottom	400 μ L	Glass	Y	500/pk	5181-3377
Vial insert, flat bottom	400 μ L	Deactivated glass	Y	500/pk	5183-2086
Cap for 350 μ L glass insert				1,000/pk	5188-5322



5181-8872



5183-2085



5181-3377



5182-3454



5182-0567

Tips and tools

You can also use our Vial Selection Tool to search by instrument manufacturer. Visit www.agilent.com/chem/order-infinitylab-well-plates-sealing-mats

Well plates

All well plates are made using polypropylene.

No. of Wells	Well Volume	Well Shape	Bottom Shape	Height	Unit	Part No.	Recommended Mat
96	2.0 mL	Square	U	41 mm	30/pk	5043-9300	5043-9319
96	1.7 mL	Round	U	45 mm	30/pk	5043-9302	5043-9317/5043-9318
96	0.9 mL	Round	U	32 mm	50/pk	5043-9305	5043-9317/5043-9318
96	1.0 mL	Round	U	27 mm	25/pk	5043-9308	5043-9317/5043-9318
96	1.0 mL	Round	U	27 mm	50/pk	5043-9309	5043-9317/5043-9318
96	0.45 mL	Round	U	14 mm	30/pk	5043-9310	5042-1389
96	0.45 mL	Round	U	14 mm	120/pk	5043-9311	5042-1389
96	0.3 mL	Round	V	14 mm	25/pk	5043-9312	5042-1389
96	0.3 mL	Round	V	14 mm	50/pk	5043-9313	5042-1389
96	0.3 mL	Round	V	14 mm	100/pk	5043-9314	5042-1389
384	0.17 mL	Square	V	22 mm	25/pk	5043-9315	5043-9320

Mats

All mats are made with silicone and are preslit for best use with HPLC samplers.

No. of Wells	Well Shape	Unit	Part No.
96	Round	50/pk	5043-9317
96	Round	100/pk	5043-9318
96	Square	50/pk	5043-9319
384	Square	50/pk	5043-9320
96	Round	50/pk	5042-1389



5043-9310
5042-1389



5042-1389

Containment Solutions for Sample Volumes of 2 mL

Vials

Description	Certified	100/pk	1,000/pk	10,000/pk	50,000/pk	100,000/pk
Crimp top						
Clear	Y	5181-3375	5183-4491			5185-5852
A-Line, clear, with write-on spot	Y	5190-9591				
Clear, with write-on spot	Y	5182-0543	5183-4492			
Clear, wide	Y			5190-6116	5190-6123	
Clear, wide, with write-on spot	Y			5190-6117	5190-6124	
A-Line, amber, with write-on spot	Y	5190-9592				
Amber, with write-on spot	Y	5181-3376	5183-4493	5190-6113		
Crimp/snap top polypropylene for CE						
Clear		5182-9697				
Amber, with write-on spot		5183-4619				
Screw top						
Clear, 8-425		5183-4428				
Clear	Y	5182-0714	5183-2067			5185-5918
A-Line, clear, with write-on spot	Y	5190-9589				
Clear, with write-on spot	Y	5182-0715	5183-2068		5190-6126	
Clear, with write-on spot, 8 mm		8010-0010				
Amber, 8-425		5183-4429				
Amber	Y	5188-6535	5188-6536	5190-6114	5190-6121	
A-Line, amber, with write-on spot	Y	5190-9590				
Amber, with write-on spot	Y	5182-0716	5183-2069	5190-6115	5190-6122	
Amber, with write-on spot, 8 mm		8010-0012				
Snap top						
Clear		5182-0544	5183-4504		5185-5934	
Clear, with write-on spot		5182-0546	5183-4505			
Amber, with write-on spot	Y	5182-0545	5183-4506			
Deactivated (silanized) crimp top						
Clear	Y	5183-4494				
Clear, with write-on spot	Y	5183-4495				
Amber, with write-on spot	Y	5183-4496				

(continued)



5181-3375



5183-2067



5182-0716

Description	Certified	100/pk	1,000/pk	10,000/pk	50,000/pk	100,000/pk
Deactivated (silanized) screw top						
Clear	Y	5183-2070				
Clear, 8-425		5183-4432				
Clear, with write-on spot	Y	5183-2071				
Amber, 8-425		5183-4433				
Amber, with write-on spot	Y	5183-2072				

Crimp Caps

Cap Color	Septa Type	Certified	25/pk	100/pk	500/pk	1,000/pk	5,000/pk	10,000/pk	100,000/pk
11 mm crimp caps									
Blue aluminum	Red PTFE/rubber			5181-1215					
Blue aluminum	Clear/red PTFE/silicone			5190-9045					
Blue aluminum	PTFE/silicone/PTFE	Y				5190-4074			
Gold steel, magnetic	White silicone/PTFE			5188-5386					
Green aluminum	Red PTFE/rubber			5181-1216					
Green aluminum	PTFE/silicone/PTFE	Y				5190-6096			
Red aluminum	Red PTFE/rubber			5181-1217					
Red aluminum	PTFE/silicone/PTFE	Y				5190-4075			
Silver aluminum	Black fluorocarbon	Y		5181-1212					
Silver aluminum	PTFE/butyl			8010-0051					
Silver aluminum	Red PTFE/rubber			5181-1210	5061-3370	5183-4498	5190-4053		5185-5851
Silver aluminum	Rubber			5190-6151					
Silver aluminum	PTFE/silicone	Y		5182-0552		5183-4500			
Silver aluminum	PTFE/silicone						5190-4052	5190-3186	
Silver aluminum	PTFE/silicone/PTFE	Y		5181-1211		5183-4499			
Silver aluminum	PTFE/silicone/PTFE						5190-4051		
Silver aluminum	Thin membrane	Y	5190-6169	5182-0871					
Silver aluminum	Preslit PTFE/silicone			8010-0582					
8 mm crimp caps									
Silver aluminum	PTFE/silicone/PTFE					5180-0842			



5188-5386

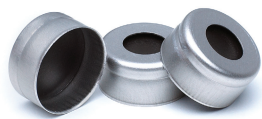

5181-1212

Ordering Information

Screw Caps

Cap Description	Septa Type	Certified	100/pk	250/pk	500/pk	1,000/pk	5,000/pk	50,000/pk
12 mm screw caps								
Mixed colors (5 packs of 50)	PTFE/silicone	Y	5182-0721	5040-4682				
9 mm screw caps								
Black	PTFE/red silicone	Y	5185-5838					
Blue, bonded	Preslit PTFE/red silicone		5185-5824		5040-4649			
Blue, bonded	PTFE/red silicone		5185-5823					
Blue, bonded	PTFE/white silicone	Y	5190-7021					
Blue, bonded	Preslit PTFE/white silicone	Y	5190-7023					
Blue, bonded	PTFE/red silicone	Y	5190-7024					
Blue	Preslit PTFE/red silicone	Y	5183-2076		5185-5865			
Blue	PTFE-lined solid top	Y	5183-2075					
Blue	PTFE/red silicone	Y	5182-0717		5185-5820	5190-1599	5190-4049	5185-5917
Blue	PTFE/white silicone	Y	5182-0720		5185-5862		5190-4050	
Blue	PTFE/red silicone		5190-3156			8010-0186		
Blue	PTFE/red silicone/PTFE	Y	5182-0723			8010-0187		
Blue	PTFE/white silicone	Y			5185-5863			
Blue, open top	No septa	Y	5182-0728					
Blue, magnetic	PTFE/red silicone	Y	5191-8160					
Blue, magnetic	Preslit PTFE/red silicone	Y	5191-8161					
Green, bonded	PTFE/red silicone	Y	5190-7025					
Green, bonded	PTFE/white silicone	Y	5190-7026					
Green, bonded	Preslit PTFE/red silicone	Y	5190-7028					
Green	Preslit PTFE/red silicone	Y	5183-2077					
Green	PTFE/red silicone	Y	5182-0718		5185-5829			
Green	PTFE/white silicone	Y	5182-0721		5185-5864			
Green	PTFE/red silicone/PTFE	Y	5182-0724		5185-5861			
Green, open top	No septa	Y	5182-0727					
Purple	PTFE/silicone	Y	5040-4681					
Red, bonded	PTFE/red silicone	Y	5190-7029					
Red, bonded	PTFE/white silicone	Y	5190-7030					
Red, bonded	Preslit PTFE/red silicone	Y	5190-7032					

(continued)



5185-5823



5182-0717



5191-8161

Cap Description	Septa Type	Certified	100/pk	250/pk	500/pk	1,000/pk	5,000/pk	50,000/pk
Red	PTFE/white silicone/PTFE					8010-0188		
Clear, thin membrane	Clear polypropylene	Y	5191-8151					
Red	Preslit PTFE/silicone	Y	5183-2078					
Red	PTFE/red silicone	Y	5182-0719					
Red	PTFE/white silicone	Y	5182-0722					
Red	PTFE/red silicone/PTFE	Y	5182-0725					
Red, open top	No septa	Y	5182-0726					
Turquoise	PTFE/silicone		5040-4683					
8 mm screw caps								
Black	Red PTFE/white silicone		5183-4442					
Black	No septa		5183-4438					
Black	PTFE/silicone/PTFE		8010-0063					
Red	PTFE/silicone/PTFE		8010-0068					
Orange	Preslit PTFE/silicone		8010-0142					

Snap Caps

Cap Color	Septa Type	Certified	100/pk	500/pk	1,000/pk	50,000/pk
12 mm snap caps						
Blue	PTFE/red silicone		5182-3458			
Blue	PTFE/silicone		5182-0541			
Clear	Preslit PTFE/silicone		5183-4511			
Clear	Solid polyethylene membrane		5182-0542			
Clear	Red silicone/PTFE		5182-0550		8010-0189	5190-2267
Clear	PTFE/red silicone/PTFE		5182-0566			
Green	Red silicone/PTFE		5182-3457			
Red	Red silicone/PTFE		5182-3459	5182-0564		
Clear	Polyurethane		5181-1512*	5042-6491*		
Cream	Solid polyethylene olefin		5181-1507*	5181-1513*		

*Can be used for CE-based applications.



5183-2075



5183-4511



5182-0566

Ordering Information

Autosampler Vial Convenience Packs (2 mL)

Convenience packs are an easy way to get 500 of each component using one part number.

Packed in our six-drawer, reusable blue plastic cabinet, 500 vials and caps with septa installed are kept dust-free.

Description	Septa Type	Cap Color	Certified	500/pk
Crimp top				
Clear	PTFE/red rubber	Silver		5181-3400
Clear, with write-on spot	PTFE/red rubber	Silver	Y	5190-2241
Amber	PTFE/red rubber	Silver		5181-8801
Screw top				
Clear, bonded	Preslit PTFE/silicone	Blue	Y	5067-0205
Clear	Preslit PTFE/silicone	Blue	Y	5183-2079
Clear	PTFE/red silicone	Blue	Y	5182-0732
Clear	PTFE/silicone	Blue	Y	5182-0734
Clear	PTFE/silicone/PTFE	Blue	Y	5182-0736
Clear, with write-on spot	Preslit PTFE/silicone	Blue	Y	5183-2080
Clear, with write-on spot	PTFE/red rubber	Blue	Y	5182-0867
Clear, with write-on spot	PTFE/silicone	Blue	Y	5182-0868
Clear, with write-on spot	PTFE/silicone/PTFE	Blue	Y	5182-0869
Amber, with write-on spot	Preslit PTFE/silicone	Green	Y	5183-2081
Amber, with write-on spot	PTFE/red rubber	Green	Y	5182-0733
Amber, with write-on spot	PTFE/silicone	Green	Y	5182-0735
Amber, with write-on spot	PTFE/silicone/PTFE	Green	Y	5182-0737

Pre-assembled Screw Top Vial Packs (2 mL)

Pre-assembled packs come ready-to-use with the cap and septum of your choice attached to the vial. A time- and labor-saving product for use with your Agilent autosampler or any rotating tray automatic sampler.

Description	Septa Type	Cap Color	Certified	100/pk
Clear	Preslit PTFE/red silicone	Blue	Y	5183-2082
Clear	PTFE/red silicone	Blue	Y	5182-0553
Clear	PTFE/red silicone/PTFE	Blue	Y	5182-0555
Clear	PTFE/red silicone	Blue	Y	5182-0557

(continued)



Autosampler vial convenience pack



Pre-assembled screw top vial pack

Description	Septa Type	Cap Color	Certified	100/pk
Clear, with write-on spot	Preslit PTFE/red silicone	Blue	Y	5183-2083
Clear, with write-on spot	PTFE/red silicone	Blue	Y	5182-0864
Clear, with write-on spot	PTFE/red silicone	Blue	Y	5182-0865
Clear, with write-on spot	PTFE/red silicone/PTFE	Blue	Y	5182-0866
Amber	PTFE/red silicone	Green	Y	5182-0558
Amber	PTFE/red silicone/PTFE	Green	Y	5182-0556
Amber, with write-on spot	PTFE/red silicone	Green	Y	5182-0554

Vial Kits (2 mL)

Vial kits with a volume of 2 mL are packs of vials with caps. These kits are not pre-assembled and do not come in storage drawers like the convenience pack.

Vial Description	Septa Type	Cap Color	Certified	100/pk	10,000/pk	50,000/pk	100,000/pk
Crimp top							
Clear	PTFE/silicone	Silver		8010-0195			
Clear glass vial bundle	PTFE/red rubber	Silver	Y			5185-5946	
Amber	PTFE/silicone	Silver		8010-0196			
Amber	PTFE/red rubber	Silver	Y			5067-0214	
Screw top							
Clear	PTFE/red silicone	Blue	Y			5185-5950	5067-0237
Clear			Y		5190-6118	5190-6125	
Clear, with write-on spot			Y		5190-6119		
Clear	PTFE/silicone septa	Blue		8010-0198			
Clear glass vial and cap pack	Preslit PTFE/silicone	Red		8010-0425			
Clear glass vial and cap pack	PTFE/butyl	Black		8010-0426			
Clear glass vial and cap pack, standard opening (8 mm)	PTFE/silicone	Black		8010-0414			
Clear glass with write-on spot, (9 mm). Similar to Waters 186000307C, National Scientific C4000-95W, Chromacol MEL, and La-Pha-Pack 11 23 1051	Preslit PTFE/silicone	Blue		8010-0542			
Clear glass 8-425	PTFE-lined solid storage				5183-4518		
Amber	PTFE/silicone septa	Blue		8010-0199			
Amber, with write-on spot, 9 mm	Preslit PTFE/silicone	Blue		8010-0543			
Amber glass vial and cap pack, standard opening (8 mm)	PTFE/silicone	Black		8010-0415			



8010-0425



8010-0426



8010-0414

Containment Solutions for Sample Volumes (>2 mL)

Screw Top Vials (4 mL)

Description	Size	Unit	Part No.
Clear	15 x 45 mm	100/pk	5183-4448
Clear, with write-on spot	15 x 45 mm	100/pk	5067-0246
Amber	15 x 45 mm	100/pk	5183-4450
Amber, with write-on spot	15 x 45 mm	100/pk	5067-0247

Vial Kits (4 mL)

Vial Type	Septa Type	Cap Size/Color	Unit	Part No.
Clear glass Similar to Waters 186000838C, Dionex/Thermo 03-375-3G, National Scientific C4015-1	PTFE/silicone	13 mm, black	100/pk	8010-0553
Amber glass Similar to Waters 186001133C, Dionex/Thermo 03-375-3P, National Scientific C4015-2	PTFE/silicone	13 mm, black	100/pk	8010-0554
Wash vial, with fill markings	No septa		25/pk	5182-0551

Screw Caps for 4 mL Vials

Description	Material	Unit	Part No.
Black	PTFE/silicone septa	100/pk	5183-4464
Black	No septa	100/pk	5183-4461

Septa

Description	Unit	Part No.
Red PTFE/white silicone	100/pk	5183-4460
PTFE/natural rubber	144/pk	9301-1031
White virgin PTFE	1,000/pk	5183-4459

Vials (6 mL) and Associated 16 mm Caps, Caps with Septum, and Septum Only

Description	Certified	Units	Part No.
Vial, screw top, clear glass, flat bottom, 6 mL	Y	100/pk	9301-1377
Vial, crimp top, clear glass, flat bottom, 6 mL		100/pk	9301-1419
Cap, screw, with preslit PTFE/silicone septa, 16 mm		100/pk	8010-0102
Cap, screw, PTFE/silicone septa, 16 mm		100/pk	8010-0101
Septa, preslit PTFE/silicone, 16 mm	Y	100/pk	5188-2758
Septa, for 6 mL vials	Y	100/pk	9301-1378
Screw cap, for 6 mL vials		100/pk	9301-1379



9301-1377

Caps and Septa (10 mL)

Description	Material	Unit	Part No.
Snap caps and seals for 10 mL wash vials		10/pk	G6500-88027
Septa, 22 mm	PTFE/silicone	100/pk	8010-0564

Seals

Description	Unit	Part No.
Seals for wash and waste vials, 10/20/100 mL	20/pk	MLAL1000023

Headspace Vials

Description	Size	Certified	Unit	Flat Bottom	Round Bottom
Crimp top, glass					
Clear	10 mL, 23 x 46 mm	Y	100/pk	5182-0838	5183-4475
			100/pk		5190-6147
		Y	1,000/pk	8010-0179	
Clear, with graduation marks and write-on spot	10 mL, 23 x 46 mm		100/pk	5190-2285	
Clear	20 mL, 23 x 75 mm	Y	100/pk	5182-0837	5183-4474
	20 mL, 23 x 75 mm	Y	10,000/pk	5185-5957	5067-0235
Clear, with graduation marks and write-on spot	20 mL, 23 x 75 mm		100/pk	5190-2288	
Clear	22 mL		100/pk		8010-0152
Amber	10 mL, 23 x 46 mm	Y	100/pk	5067-0227	5190-2238
Amber, with graduation marks and write-on spot	10 mL, 23 x 46 mm		100/pk	5190-2287	
Amber	20 mL, 23 x 75 mm	Y	100/pk	5067-0226	5190-2239
Amber, with graduation marks and write-on spot	20 mL, 23 x 75 mm		100/pk	5190-2286	
Screw top, glass					
Clear	10 mL, 23 x 46 mm		100/pk		5188-5392
Clear	20 mL, 23 x 75 mm		100/pk		5188-2753
	20 mL, 23 x 75 mm		1,000/pk	8010-0180	
Amber	10 mL, 23 x 46 mm		100/pk		5188-6538
Amber	20 mL, 23 x 75 mm		100/pk		5188-6537



Agilent 7693A automatic liquid sampler

Ensure you have an inert sample pathway for smooth GC performance without analyte degradation or loss. Go to www.agilent.com/chem/7693a

Ordering Information

Headspace Caps

Description	Size	Septa Type	Certified	100/pk	1,000/pk	10,000/pk
Crimp caps						
Silver aluminum	20 mm	Molded PTFE/butyl	Y			5190-2258
	20 mm	PTFE/silicone	Y	5183-4477		5190-2257
	20 mm	PTFE/silicone		9301-1425		
	20 mm	Tan PTFE/white silicone			8010-0191	
	20 mm	No septa		9301-0721		
Silver aluminum, with safety feature	20 mm	Molded PTFE/butyl	Y	5183-4479		
	20 mm	Molded PTFE/butyl		5183-4480		
	20 mm	PTFE/silicone	Y	5183-4478		5067-0236
	20 mm	No septa		9301-0718		
Bimetal, magnetic	20 mm	PTFE/silicone		8010-0420		
Steel, magnetic	20 mm	Tan PTFE/silicone		8010-0165		
	20 mm	Silicone/PTFE		8010-0424		
	20 mm	High temperature septa	Y	5190-3987		
	18 mm	PTFE/butyl septa		8010-0140		
Screw caps						
Steel, magnetic	18 mm	PTFE/silicone (white top, blue bottom)		5188-2759		
	18 mm	High temperature septa		5190-3986		

Headspace Septa and Stoppers

Description	Septa Type	Certified	100/pk	1,000/pk	10,000/pk
Septa					
18 mm	Blue PTFE/silicone			8010-0418	
20 mm	Tan PTFE/white silicone	Y	9301-0719	8010-0192	
20 mm	Tan PTFE/white silicone	Y			5067-0234
20 mm	Red molded silicone/white PTFE		250-030-DAN		
Stoppers					
Gray butyl stopper, 20 mm, -40/120 °C		Y	5183-4476		



5182-0837



5183-4479



5182-0840



5188-2759

Headspace Kits

Description	Septa Type	Cap Color/Type	Certified	100/pk
Crimp top				
Glass vial, clear, flat bottom, 10 mL	PTFE/silicone	Silver		8010-0412
Glass vial, clear, flat bottom, 20 mL	PTFE/silicone	Silver		8010-0413
Glass vial, clear, flat bottom, 20 mL	PTFE/black butyl	Silver, with safety feature	Y	5182-0839
Glass vial, clear, flat bottom, 20 mL	Molded PTFE/silicone	Silver, with safety feature	Y	5182-0840
Screw top				
Glass vial, clear, round bottom, 20 mL	PTFE/silicone	Silver magnetic		8010-0417

LC High Recovery Vials

Description	Size	Certified	30/pk
Screw top, clear glass	15 mL	Y	5188-5369

Vials, Caps, and Septa for Archon Purge and Trap

Description	Size	Certified	24/pk	60/pk	72/pk	100/pk
Vial kits						
Clear, precleaned vials, caps, and septa	40 mL				5183-4741	
Amber, precleaned vials, caps, and septa	40 mL				5183-4742	
Screw caps						
Cap, screw	40 mL		5183-4744			
Cap, screw, red	40 mL	Y				5190-6172
Septa						
Precleaned, for 40 mL vials					5183-4743	
EPA low-bleed	22 mm			5190-3976		
PTFE/silicone	22 mm				5190-3978	

Storage Vials

Vial Size	Unit	Cap Size	Vial Type	Septa Type	Closed Top	Open Top
4 mL, 15 x 45 mm	100/pk	13-425	Clear	PTFE/silicone	5183-4311	5183-4331
	100/pk	13-425	Amber	PTFE/silicone	5183-4321	
12 mL, 19 x 65 mm	100/pk	15-425	Clear	PTFE/silicone	5183-4312	5183-4332
	100/pk	15-425	Amber	PTFE/silicone	5183-4322	
22 mL, 23 x 85 mm	100/pk	20-400	Clear	PTFE/silicone	5183-4313	5183-4333
	100/pk	20-400	Amber	PTFE/silicone	5183-4323	
40 mL, 28 x 95 mm	100/pk	24-414	Clear	PTFE/silicone	5183-4314	5183-4334
	100/pk	24-414	Amber	PTFE/silicone	5183-4324	
	100/pk	24-414	Amber	PTFE/silicone		5190-4000

Ordering Information

Bonded Caps

Cap Size	Unit	Cap Color	Cap Type	Septa Type	Closed Top	Open Top
13-425	100/pk	White	Polypropylene	PTFE/silicone	5183-4301	5183-4305
15-425	100/pk	White	Polypropylene	PTFE/silicone	5183-4302	5183-4306
20-400	100/pk	White	Polypropylene	PTFE/silicone	5183-4303	5183-4307
24-414	100/pk	White	Polypropylene	PTFE/silicone	5183-4304	5183-4308

Test Tubes

Description	Size	Certified	100/pk	250/pk
12 x 48 mm	3.5 mL		5022-6534	
16 x 48 mm	7 mL		5022-6533	
12 x 100 mm	8.5 mL			5022-6531
16 x 100 mm	13 mL			5022-6532
30 x 48 mm, round bottom glass	20 mL	Y	5042-6470	
16 x 150 mm	21 mL		5190-9092	
25 x 100 mm, round bottom glass	40 mL		5042-6459	
25 x 150 mm	55 mL		5190-9091	
30 x 100 mm, round bottom glass	60 mL		5042-6458	
30 x 150 mm	78 mL		5190-9090	



Agilent 90-day warranty and money-back guarantee

All Agilent vials are designed and manufactured to stringent standards under the Agilent quality system registered to ISO 9001. If Agilent receives notice of defects during the warranty period, Agilent shall either repair or replace products that prove to be defective. If Agilent is unable, within a reasonable time, to repair or replace any product to the warranted condition, the buyer shall be entitled to a refund of the purchase price upon return of the product to Agilent.



Save Time and Simplify Routine Tasks

Replace your manual crimpers with the next stage in crimping technology

Agilent handheld electronic crimpers deliver tight, reproducible seals every time. Slim, adjustable steel jaws fit around closely spaced vials, enabling you to crimp vials directly in crowded autosampler trays. Handheld electronic decappers remove caps instantly, and are designed for labs that recycle or re-use vials.

Description	Part No.
Crimper	
Electronic crimper, 11 mm, with lithium battery	5191-5616
Electronic crimper, 20 mm, with lithium battery	5191-5615
Decapper	
Electronic decapper, 11 mm, with lithium battery	5191-5614
Electronic decapper, 20 mm, with lithium battery	5191-5613
Replacement lithium battery for crimper and decapper	5190-3192



Cut your crimping time in half with Agilent high-power electronic crimpers

Electronic crimpers give you the power to crimp vials in half the time of a manual crimper. We recommend the high-power crimper if you are using steel caps.

Description	Cap Size	Part No.
High-power electronic crimping tool, with power supply		5191-5617
Base for electronic crimping tool		5190-4066
Crimper jaw set for high-power electronic crimper	11 mm	5190-4062
Decapper jaw set for high-power electronic crimp tool	11 mm	5190-4063
Crimper jaw set for high-power electronic crimper	20 mm	5190-4064
Decapper jaw set for high-power electronic crimper	20 mm	5190-4065
High-power crimping tool and jaw set bundle	20 mm	5191-5624



5190-4066
(stand only)

Stop wrist strain with ergonomic Agilent manual crimpers, for higher throughput on a limited budget

With their lightweight, tailored design, Agilent manual crimpers and decappers help eliminate the problem of sore, pinched hands. They are also built to last; the 11 mm crimper will complete at least 100,000 cappings, and the 20 mm crimper will complete at least 60,000 cappings.

Description	Cap Size	Part No.
Crimper		
Ergonomic manual crimper	11 mm	5040-4667
Ergonomic manual crimper	20 mm	5040-4669
Decapper		
Ergonomic manual decapper	11 mm	5040-4668
Ergonomic manual decapper	20 mm	5040-4671



5040-4667

Tips and tools

Watch our “Crimping a Vial Made Easy” video at www.agilent.com/chem/crimpingvideo

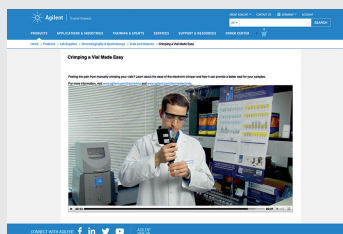

The right vial is only a few clicks away

Use our online selection tool to quickly find the right products for complete confidence in your sample containment.

- Answer a few simple questions to identify your best options
- Search by technique, product number, vial type, or instrument manufacturer
- Choose from over 600 vials, caps, and septa

Go to www.agilent.com/chem/selectvials

Technical support

Have a hardware, software, application, instrument repair, or troubleshooting question? Agilent technical experts are available to answer your questions. With years of laboratory experience, our technical support specialists can provide in-depth knowledge and experience.

For questions about supplies found in this catalog, contact your local Agilent office or authorized Agilent distributor. Or visit www.agilent.com/chem/techsupport.

Agilent CrossLab: Supporting Your Success

CrossLab is an Agilent capability that integrates services and consumables to support workflow success, improve productivity, and enhance operational efficiency. In every interaction, we strive to provide insights that help you achieve your goals. We offer a wide range of products and services – from method optimization and training to full-lab relocations and operations analytics – to help you manage your instruments and your lab for best performance.

Learn more about CrossLab at www.agilent.com/crosslab.

Need more information?

Visit www.agilent.com/chem/contactus to:

- Locate your nearest Agilent office or distributor for expert technical support.
- Get fast sales and product assistance by phone. Simply use the scroll-down menu to select your country.
- Receive email assistance using our convenient online forms.



Learn more

www.agilent.com/chem/vialsresources

Contact us:

www.agilent.com/chem/contactus

Buy online:

www.agilent.com/store

Get social with Agilent:

www.agilent.com/chem/social

Explore our full range of catalogs:

www.agilent.com/chem/catalog

DE94864253

This information is subject to change without notice.

© Agilent Technologies, Inc. 2022
Published in the USA, December 13, 2022
5994-4803EN

