

BEIS(Boost efficiency IS) **-High sensitivity ion source for GC-MS/MS-**

MS Business Unit, Analytical & Measuring Instruments Division

Background

● Market trend of GC-MS/MS

- In the past, Dioxins in food had been analyzed by GC-HRMS
- Recently, GC-MS/MS was also confirmed as official method (EU589/2014)
- The market will grow in Europe, Asia and Africa where export food to Europe

● Trend of regulation for POPs analysis by GC-MS/MS

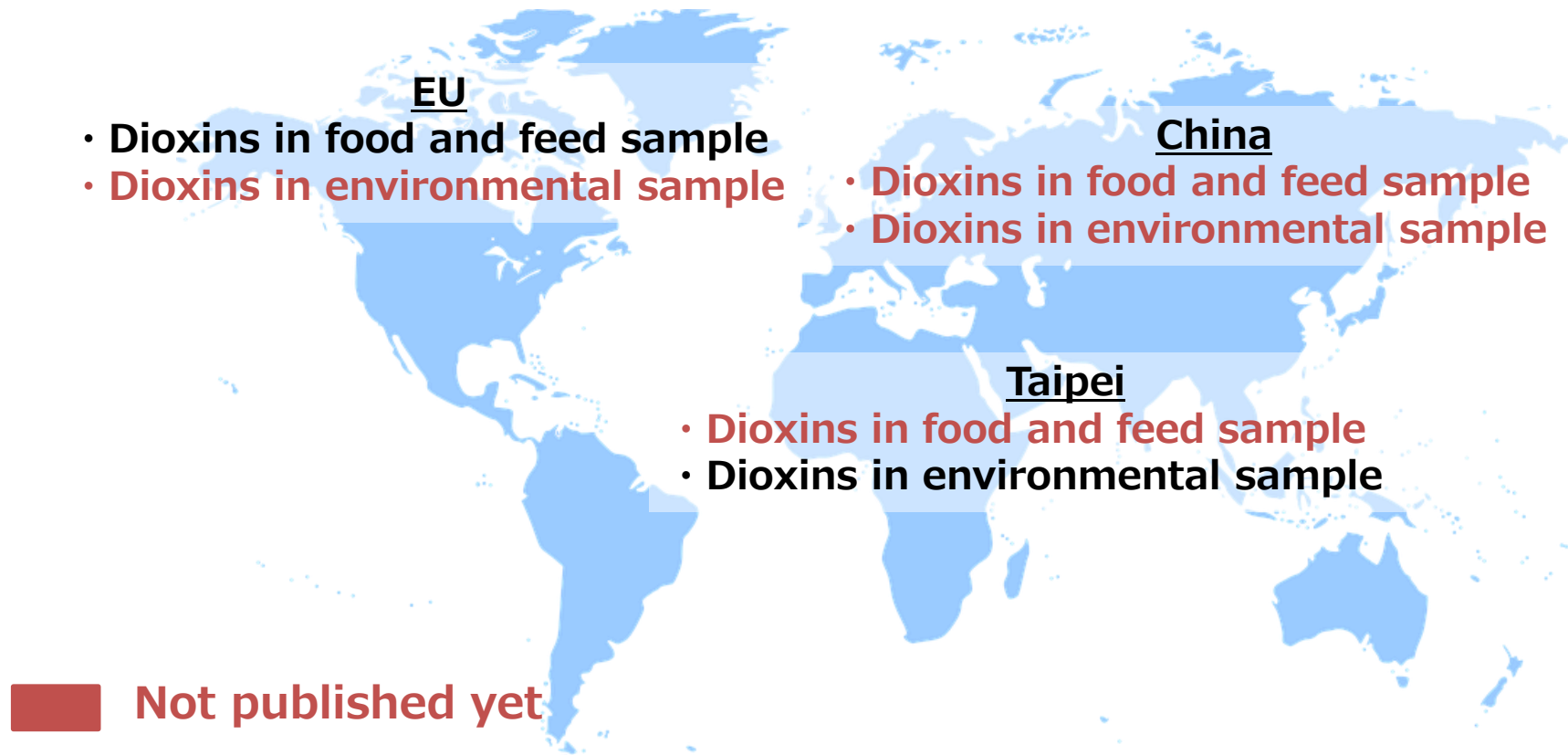

Background

- **Market trend of Dioxin analysis (in EU)**

- ML is getting lower and lower

Food and Feed	Maximum level	
	Conc. in sample	Conc. in vial
Pigs fat	1,00 pg/g fat	0.06 pg/uL
Vegetable oils	0,75 pg/g fat	0.04 pg/uL
Foods for infants and young children	0,10 pg/g wet weight	0.04 pg/uL

High sensitivity ion source is necessary

Features of BEIS(Boost efficiency IS)

- **Improve the structure of ion source**

- Diameter of electron gun was optimized
- Ionization efficiency was much improved

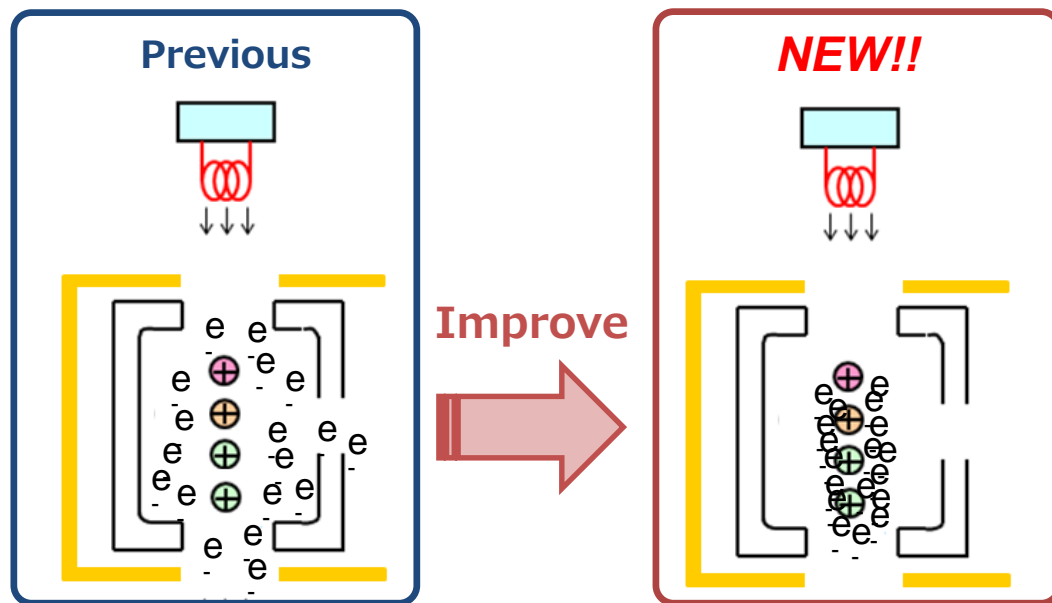

1. **Boost up sensitivity of your analysis**
2. **Realize high reliable analysis for Dioxins**

Boost up sensitivity of your analysis

- Increase the sensitivity for 3 – 4 times

Analysis result of DXNs

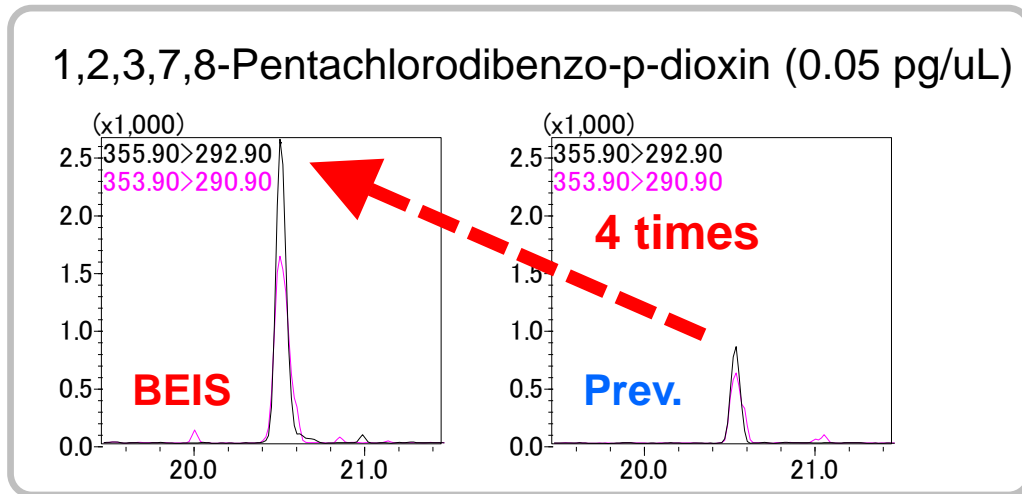

Analysis result of OFN

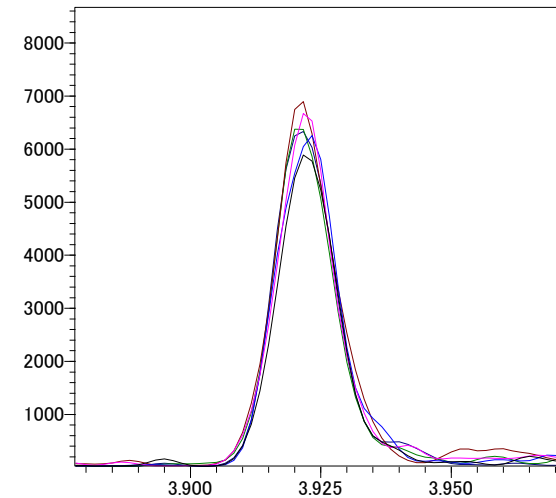

Octafluoronaphthalene (1 fg)

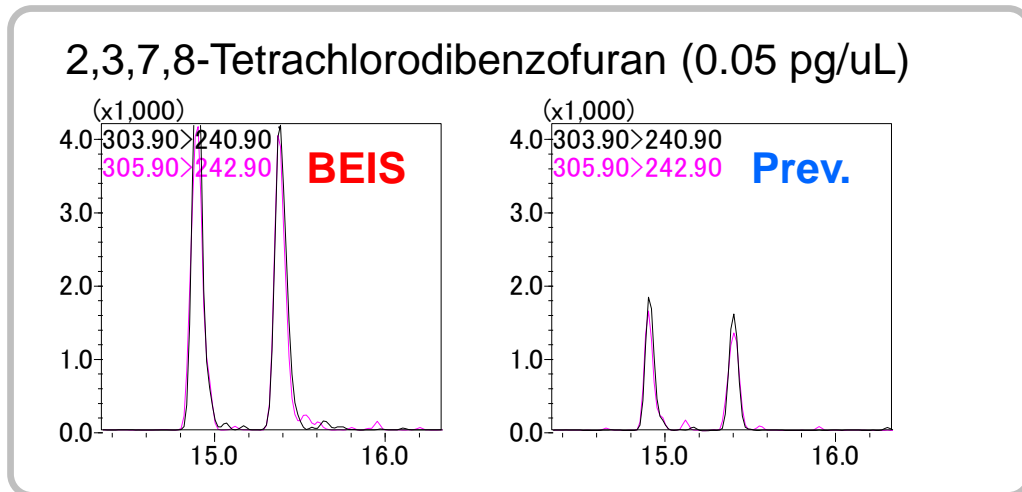

Spec. (IDL) of the ion source

Company	Model	Spec.
SHIMADZU	TQ8050NX+BEIS	OFN : IDL \leq 0.3fg

Realize high reliable analysis for Dioxins

- Realize high sensitivity analysis even if use low emission current

2,3,7,8-Tetrachlorodibenzofuran

BEIS with 150uA

Prev. with 300uA

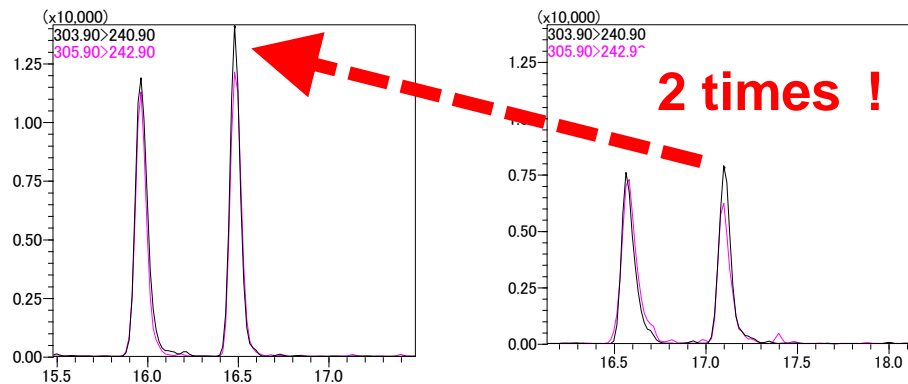

1,2,3,7,8,9-Hexachlorodibenzo-p-dioxin

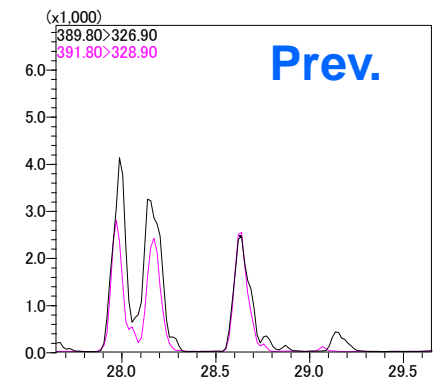
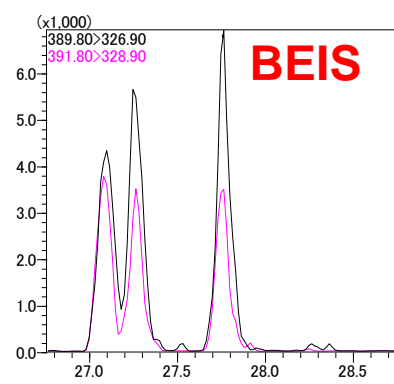

1,2,3,7,8-Pentachlorodibenzofuran

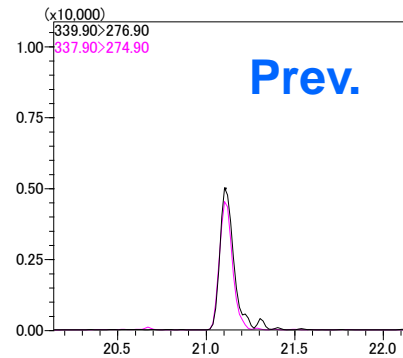
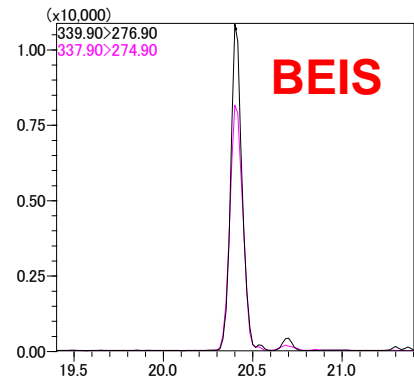

Octachlorodibenzofuran

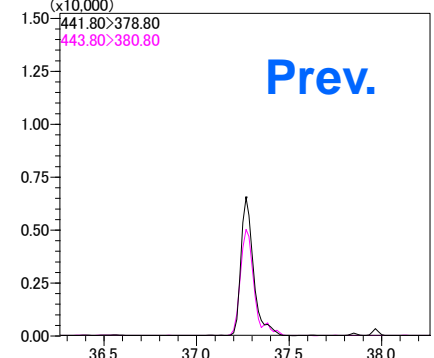
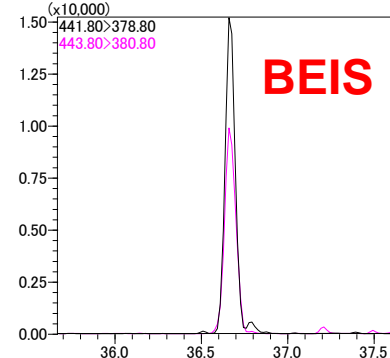

Realize high reliable analysis for Dioxins

- Keep the sensitivity over than 500 injection in Dioxin analysis
Transition of the sensitivity of STD (0.05 pg/uL)

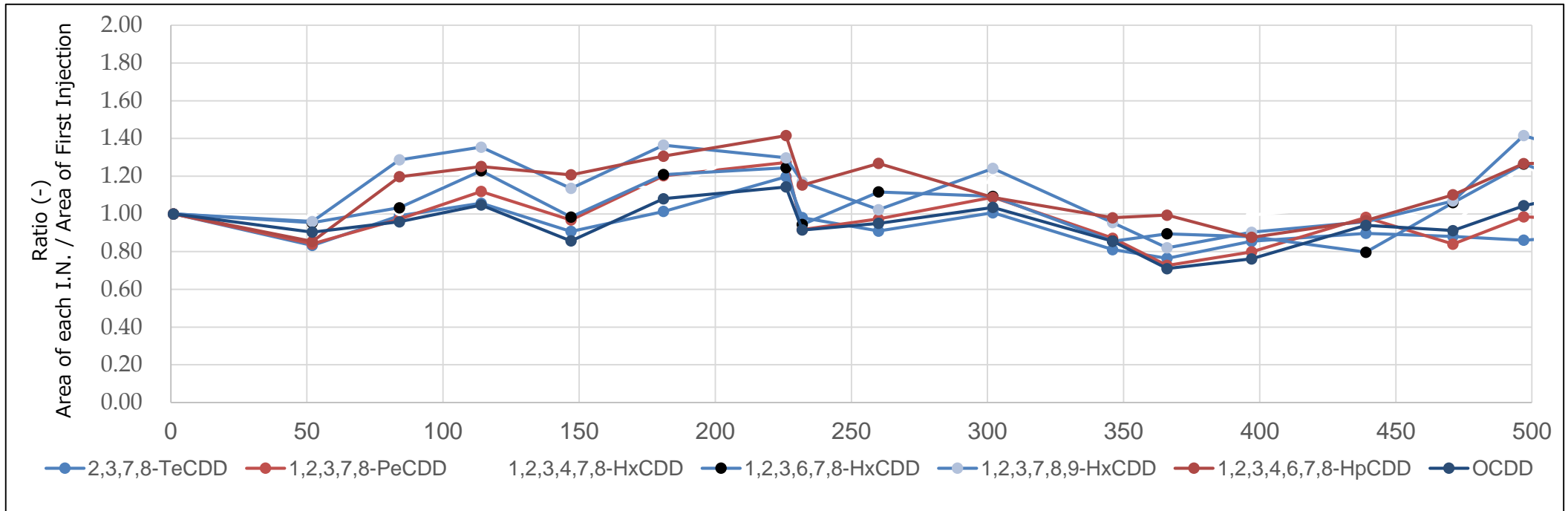
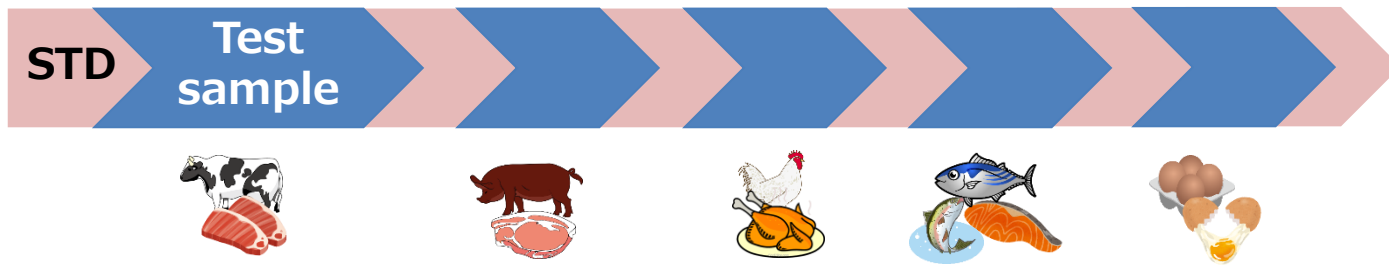

Transition of Peak Area (PCDD)

Note

● Lifetime of Filament

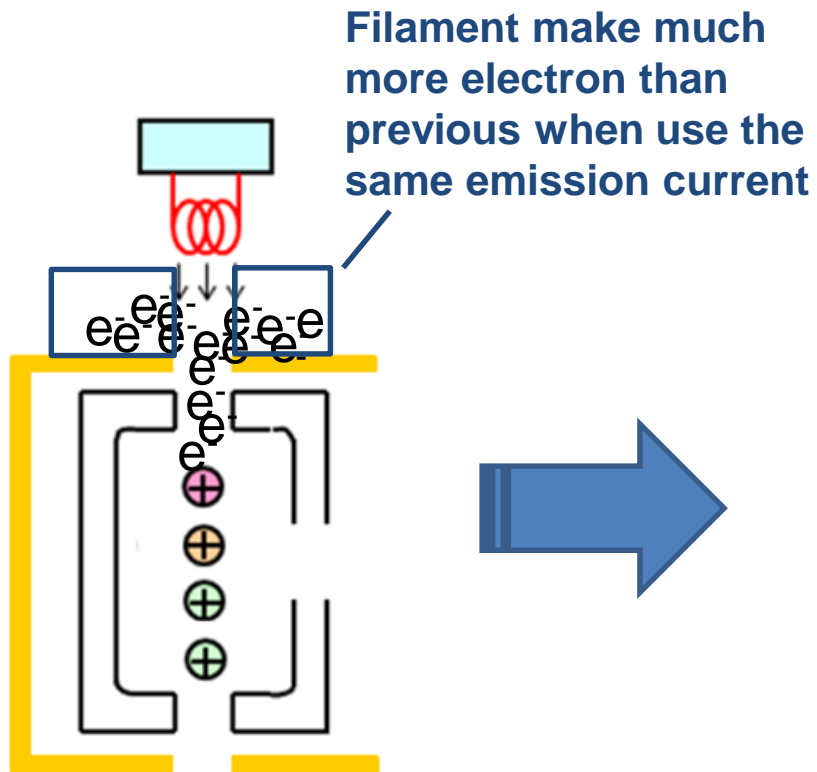

Lifetime of filament may be shorter

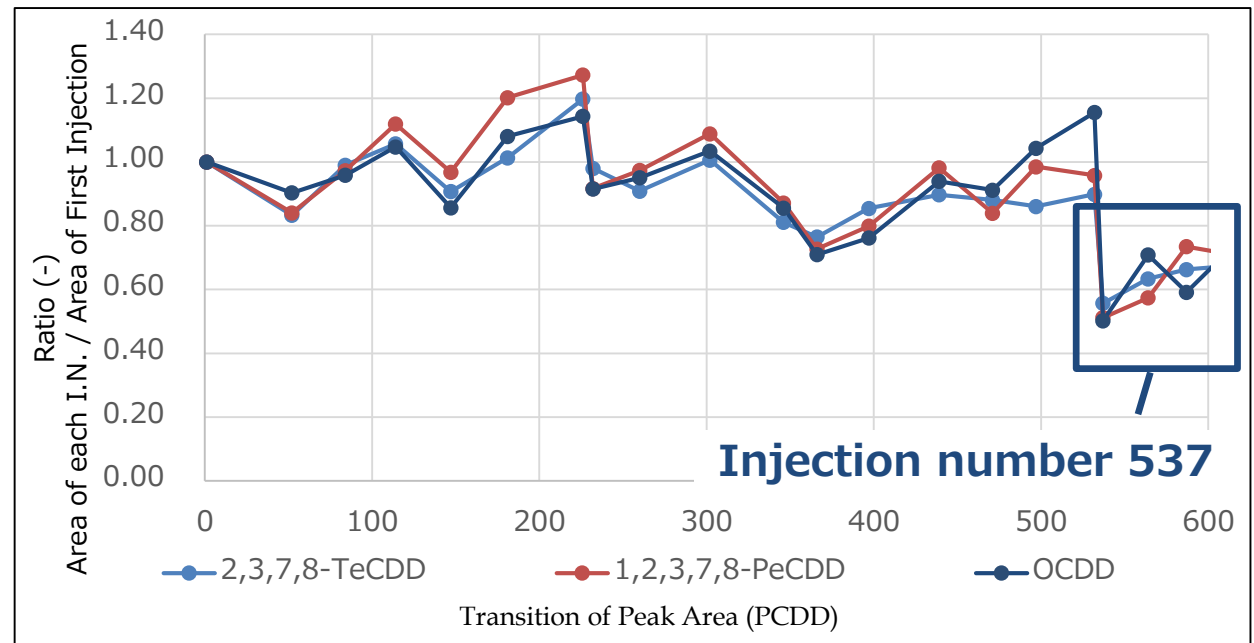

- BEIS is suitable for POPs analysis especially Dioxins.
- For other applications (such as pesticides in food), the sensitivity is enough even if use current ion source. We should recommend current ion source because of filament lifetime.

Fin.