

LC World Talk Special Issue Volume 2

# Tips for practical HPLC analysis

—Separation Know-how—

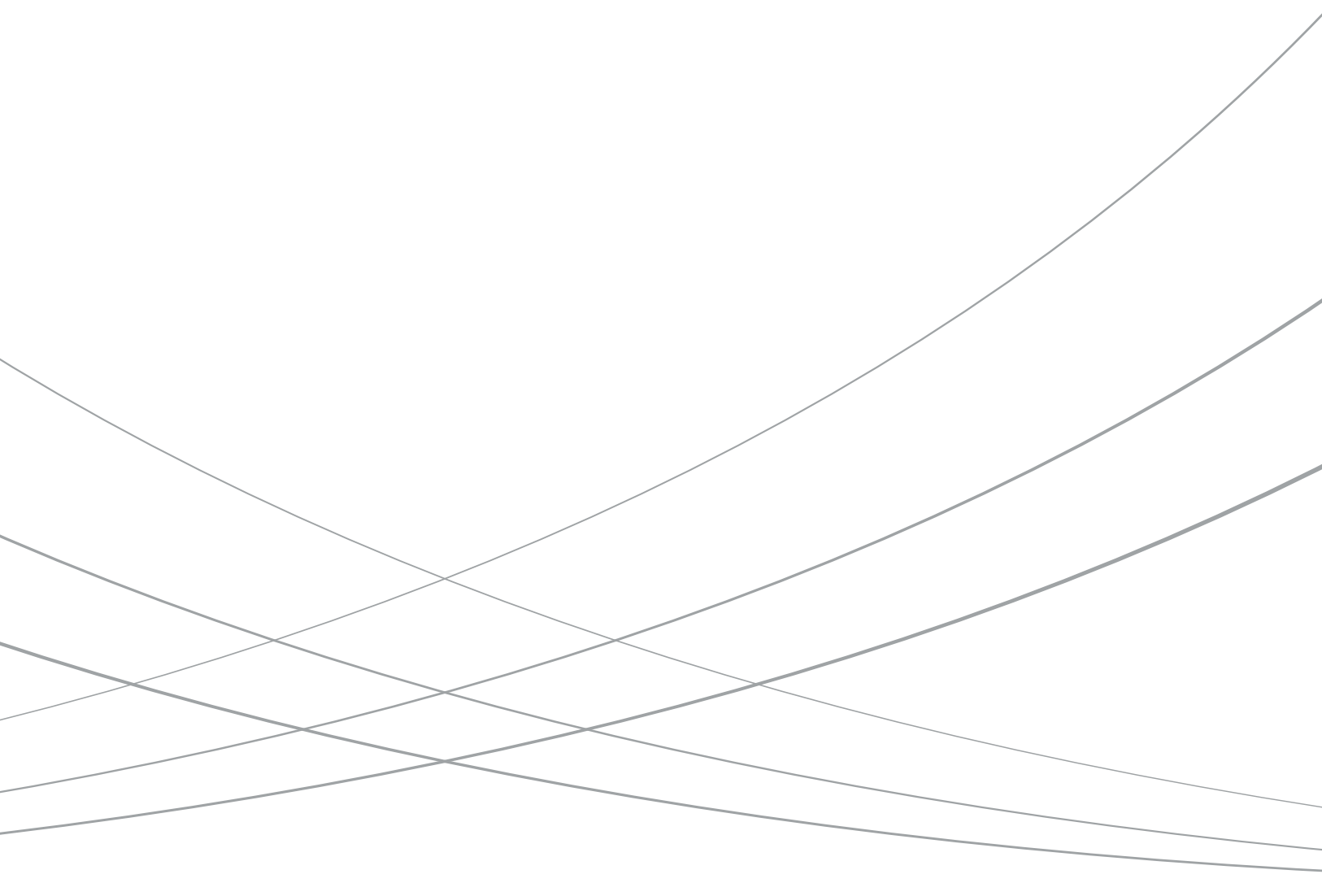





This is a compilation of articles related to tips for preparation of mobile phase and samples from introductory, laboratory and technical sections of past issues of the "LCtalk", Shimadzu's newsletter for HPLC users, Japanese version.

<b>Contents</b>	<b>Page</b>
1. Preparation of Mobile Phases	<b>4</b>
2. Differences between Acetonitrile and Methanol in Reversed Phase Chromatography	<b>6</b>
3. Preparing Mobile Phases - Solvent Mixing Ratio -	<b>8</b>
4. Preparing Buffer Solutions	<b>9</b>
5. pKa and Dissociation Equilibrium	<b>10</b>
6. Water Grade	<b>11</b>
7. Gradient Baseline for Acetonitrile Containing TFA	<b>12</b>
8. Ion-Pair Chromatography - Choosing between Alkyl Sulfonate and Perchloric Acid -	<b>14</b>
9. Measuring Accurately with Electronic Balances	<b>16</b>
10. Causes of Quantitative Errors Originating in Sample Preparation	<b>18</b>
11. Peaks Caused by Dissolved Air in Sample Solvents	<b>20</b>
12. Influence of Sample Solvent on Peak Shape	<b>22</b>
13. Check Methods for Abnormal Increases in Solvent Delivery Pressure	<b>23</b>
14. Internal Standard Method	<b>26</b>
15. Formulas for Number of Theoretical Plates	<b>27</b>

# Preparation of Mobile Phases

Aqueous solvents, organic solvents, and mixtures of these types of solvents are usually used as the mobile phase in high performance liquid chromatography (HPLC). Buffer solutions are often used as aqueous solutions. Specific preparation methods for some of the representative buffer solutions used in HPLC are given on page 9. In general, however, there are many cases where the definition of buffer solutions is vague. There are also cases where, because of differences between the instructions given in documentation and the actual preparation methods used, disparities in mobile phases occur that will affect the chromatograms and the analysis results. There are many aspects of mobile phase preparation that can be thought of as blind spots. This applies not just to buffer solutions but also, for example, to solvent mixing methods. Here, using phosphate buffer as an example, we will look at the effect that the mobile phase preparation method can have on analysis results.

## 1) Preparation of Buffer Solutions

In general, how is something described as "20 mM phosphate buffer solution (pH 2.5)" actually prepared? We will look at several possible cases. First, let us assume that we are talking about a

buffer solution that uses phosphoric acid, but that the counterions are unclear. If we assume that they are sodium ions, the next problem is that we do not know whether the "20 mM" refers to the concentration of the phosphoric acid or sodium phosphate. If we think of this solution as "20 mM phosphoric acid (sodium) buffer solution", we can consider "20 mM" to be the concentration of phosphoric acid. If, however, we consider "20 mM" to be the concentration of sodium, we can think of this solution as a "buffer solution created by the pH adjustment of an aqueous solution of 20 mM sodium dihydrogen phosphate". (The pH value of an aqueous solution of 20 mM sodium phosphate is roughly 5.0, so in order to attain a pH value of 2.5, pH adjustment with some acid is required.) Depending on the acid used for pH adjustment, the ion-pair effect may occur, and there may be some influence on the analysis results. We can see then that there are several possible interpretations for the term "buffer solution".

Fig. 1 shows the effect on the analysis results of interpreting the above example three different ways. The top line shows the result obtained by interpreting "20 mM" as the concentration of phosphoric acid and using a solution prepared as "20 mM

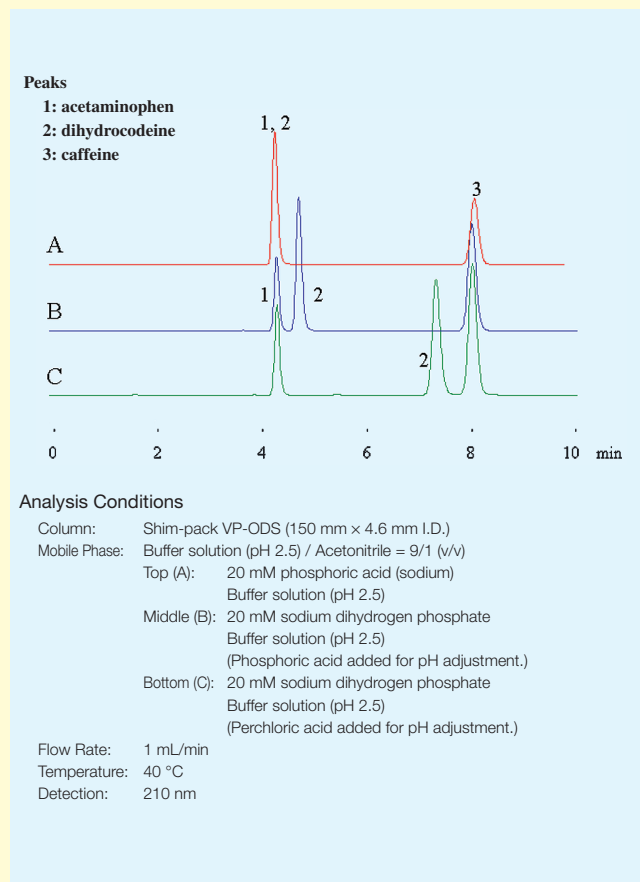
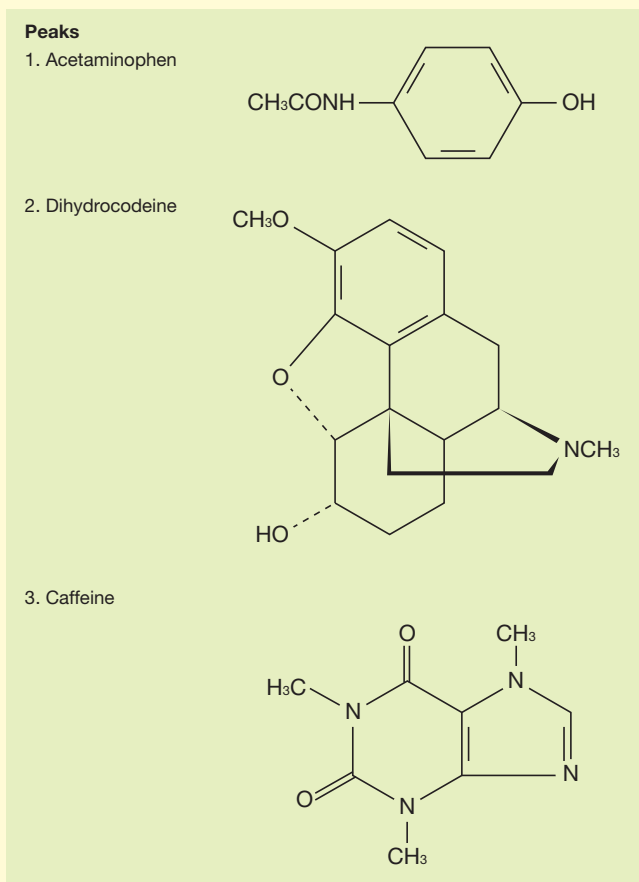

Fig. 1 Influence of pH Adjustment Method Used for Buffer Solutions

phosphoric acid (sodium) buffer solution (pH 2.5)" as the mobile phase. The middle and bottom lines show the results obtained by interpreting "20 mM" as the concentration of sodium dihydrogen phosphate, and adjusting the pH value to 2.5 by respectively adding phosphoric acid and perchloric acid. As illustrated by dihydrocodeine in this example, there are cases where the retention time and consequently the robustness of the analysis technique are significantly affected.

Indicating the preparation method for buffer solutions so that the solution can be accurately identified helps to prevent problems resulting from differences in interpretation.

## 2) Mixing Organic Solvents and Aqueous Solvents

Solutions obtained by mixing organic solvents and aqueous solvents are sometimes used as mobile phases. The way in which mixing is performed can have a significant effect on the analysis results. As an example, let us consider a mixture that is 90% 20 mM phosphoric acid (sodium) buffer solution (pH 2.5) and 10% acetonitrile. If we consider this description to indicate that the mixing ratio is 9:1, this implies that the ratio of the volume of 20 mM phosphoric acid

(sodium) buffer solution (pH 2.5) to that of acetonitrile is 9:1; in other words, amounts corresponding to this ratio are measured out and mixed. On the other hand, if we consider this description to simply mean "10% acetonitrile", this implies that 20 mM phosphoric acid (sodium) buffer solution (pH 2.5) is used, and is diluted with acetonitrile. Applying the latter interpretation changes the relative volumes and consequently the amount of 20 mM phosphoric acid (sodium) buffer solution is larger. There is a tendency to think that there is no significant difference between these two interpretations. Fig. 2, however, shows how the mixing method used can have a significant effect on the analysis results (particularly retention times). In general, regarding the preparation of mobile phases for HPLC, it seems that the notation "A:B = 3:2 (V:V)", indicating that an amount of solution A corresponding to a relative volume of 3 and an amount of solution B corresponding to a relative volume of 2 are separately measured out and mixed together, is commonly used. (In practice, the total volume of the mixture will be less than a relative volume of 5.)

The problems mentioned above occur not only in the preparation of mobile phases, but also in the preparation of sample solutions and other solutions. Also, different practices and conventions are used in different fields (e.g., pharmaceuticals, chemical industry), further adding to the potential causes of confusion. Official documents, such as the Japanese Pharmacopoeia, Standard Methods of Analysis for Hygienic Chemists, and Japanese Industrial Standards (JIS) give general principles and definitions related to the preparation of solutions. It is advisable to refer to these documents and to strive on a daily basis to use notation that avoids confusion.

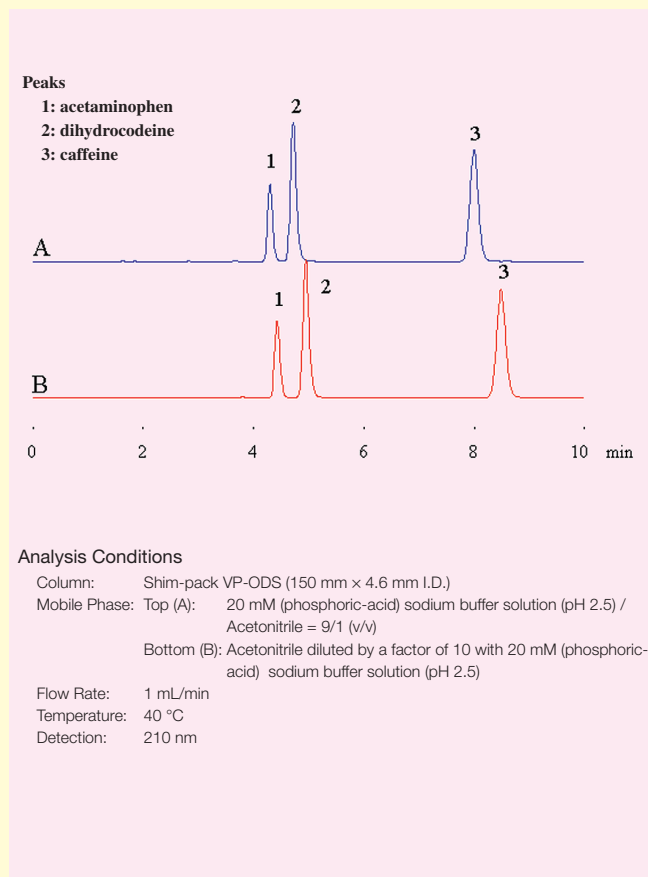

Fig. 2 Influence of Mixing Method Used for Mobile Phase

# Differences between Acetonitrile and Methanol in Reversed Phase Chromatography

## 1. Acetonitrile Is More Expensive

The organic solvents acetonitrile and methanol are often used as the mobile phase in reversed-phase chromatography. Commercial prices of these solvents are relatively expensive, particularly Acetonitrile for HPLC. Acetonitrile appears more often, however, in related literature and conditions specified by HPLC manufacturers. Here, we will be looking at the reasons for this.

## 2. HPLC-Type Acetonitrile Has Less Absorbance

Fig. 1 and 2 show absorption spectra for acetonitrile and methanol (commercial HPLC type and special grade). "HPLC type" does not indicate that the solvent has a high absolute purity. This type is created by removing impurities that have UV absorbance and the absorbance for specified wavelengths is suppressed so as to lie below certain levels. It can be seen that, out of these four reagents, HPLC-type acetonitrile has the lowest absorbance (particularly for short wavelengths). Using an organic solvent with lower absorbance as the mobile phase results in less noise in UV detection, and so HPLC-type acetonitrile is suitable for high-sensitivity analysis in the UV short-wavelength range. Also, using HPLC-type acetonitrile means that there are fewer ghost peaks for gradient baselines in UV detection. There are many other organic solvents that have a high compatibility with water but none with a lower absorbance than HPLC-type acetonitrile have been found.

Let us look at an example of a problem related to the reagent grade. Analyst A measured ephedrine in ephedra at 210 nm but could only obtain data with a noise level much higher than that in the data obtained by his predecessor. He concluded that there was a problem with his analytical technique but learned, on consulting his predecessor, that HPLC-type acetonitrile was used before. Analyst A had thought that this was an unnecessary expense and so he used special grade. This was the problem. He had been struggling with a mobile phase giving a background level well over ten times as large. After this, they made it a rule to clearly indicate the reagent manufacturer and the grade.

There is no significant difference in the spectra obtained with HPLC-type methanol and special-grade methanol but the absorbance level for the special grade is not guaranteed and so there may be some

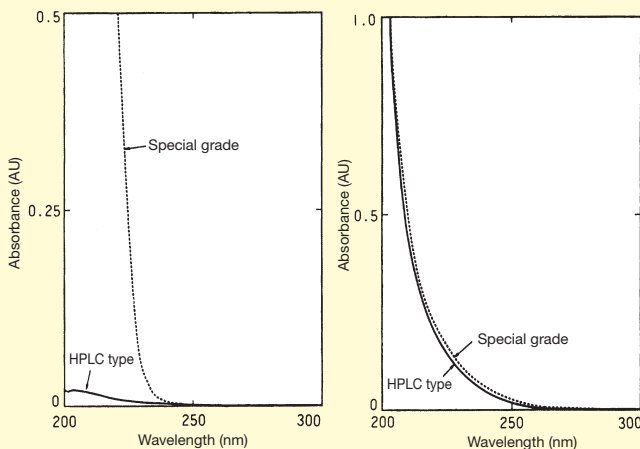

Fig. 1 Absorbance Spectra for Acetonitrile Reagent

Fig. 2 Absorbance Spectra for Methanol Reagent

inconsistency. There is not much difference in the price and so, if possible, we should use the HPLC-type.

## 3. The Pressure with Acetonitrile Is Lower

The pressure applied to the column varies with the type of organic solvent and the mixing ratio. Fig. 3 shows some examples illustrating the relationship between the mixing ratio and the delivery pressure for water/acetonitrile and water/methanol mixtures. The pressure for methanol increases significantly with the proportion of water, whereas the increase for acetonitrile is not so marked. Therefore, if acetonitrile is used, undue pressure is not applied to the column for the same flow rate.

The two points given above explain why acetonitrile is used. Are there not, then, any benefits obtained by using methanol, other than the lower price? Other aspects are compared below.

## 4. In General, Acetonitrile Has a Higher Elution Capacity

If acetonitrile and methanol are mixed together with water in the same proportion, in general, the elution capacity will be higher for acetonitrile. With low mixing ratios in particular, as seen with caffeine and phenol, the same retention times can be obtained with a proportion of acetonitrile that is less than half that of methanol. (See Fig. 4.) However, in cases where 100% organic solvents (or closely approximating solutions) are used, as seen with carotene and cholesterol, methanol sometimes exhibits a higher elution capacity. (See Fig. 5.) The behavior of mixed solvents is difficult to understand but, in this case, it seems that the behavior (polarity) of the single

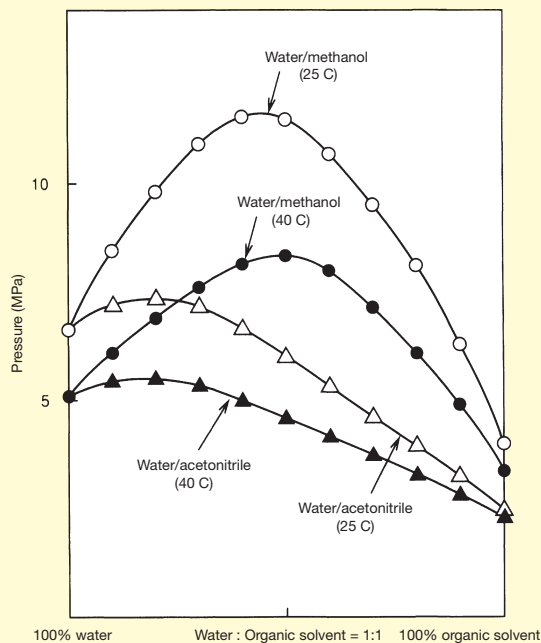

Fig. 3 Relationship between Mixing Ratio of Organic Solvent and Pressure

Column : STR ODS-2 (4.6 mm I.D. 150 mm L)  
Flow rate : 1 mL/min



solvent is more prominent.

In extreme cases, with a mixing ratio of 50 to 1, for example, errors made in preparation can significantly affect retention times, and a long time may be required to reach equilibrium. If this sort of problem is experienced with acetonitrile, methanol may be a more practical alternative if analysis can be performed using it with a smaller ratio (e.g., 10 to 1).

If there are differences in the solvent temperature, measuring out solvents by weight rather than volume (taking specific gravity into account) reduces discrepancies in the mixing ratio and so this method is sometimes used.

### 5. Selectivity of Separation (Elution) Is Different

The selectivity of separation differs between acetonitrile and methanol. In the example shown in Fig. 6, the elution order for phenol and benzoic acid is different in the two cases. (Note that, if the proportion of water is high, phenol is eluted first with acetonitrile too.) This is believed to result from differences in the chemical behavior of the organic solvent molecules. (Methanol and ethanol are protic and acetonitrile and tetrahydrofuran are aprotic.)

It is therefore reasonable to conclude that, if selectivity of separation cannot be attained with acetonitrile, then analysis should be tried using methanol.

### 6. Sometimes Peak Shapes Are Different

In the analysis of compounds such as salicylic acid (i.e., phenol compounds with a carboxyl group or methoxy group in the ortho position), there are cases where using acetonitrile results in a significant amount of tailing, whereas using methanol suppresses this. This is believed to be because (1) the action of the mobile phase on the (adsorptive) interaction between the silica surface and the target constituent varies with the chemical behavior of the organic solvent molecules and (2) the dissolving power with respect to the constituent is different.

There is a tendency for peaks obtained with polymer reversed-phase columns to be broader than those obtained with silica columns. This is often observed in the analysis of aromatic compounds performed with polystyrene columns. It is particularly noticeable if a methanol mobile phase is used, whereas it is not noticeable if an acetonitrile mobile phase is used. The latter is recommended for use with polymer reversed-phase columns. This is because it is believed that acetonitrile causes pores in the gel to swell.

### 7. Care Is Required in Degassing of Acetonitrile

This applies when mixed solvents are prepared, not in HPLC instruments, but beforehand in mobile phase bottles (i.e., isocratic systems).

When methanol is mixed with water, heat is generated, and surplus dissolved air turns into bubbles, making it easier for the air to escape. With acetonitrile, however, the solution absorbs heat and cools down, and so bubbles are formed later as it gradually returns to room temperature. Consideration is therefore required for degassing. (heating and stirring, membrane degassers, and helium purges.)

### 8. Summary

This completes our comparison of acetonitrile and methanol, which are often used as the mobile phase in reversed-phase liquid

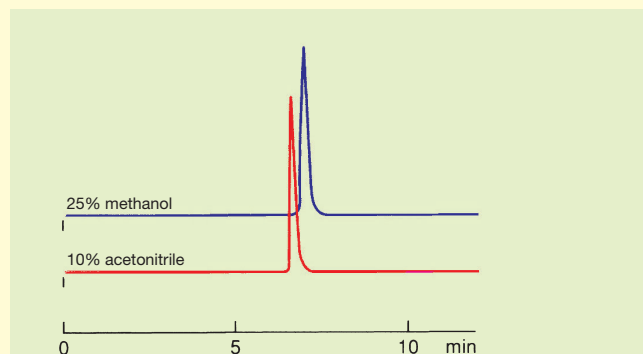

Fig. 4 Elution Example for Caffeine  
Flow rate: 1 mL/min

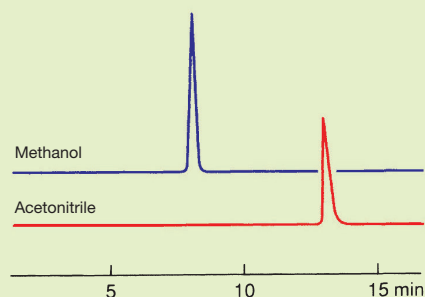

Fig. 5 Elution Example for Cholesterol  
Mobile phase: Organic solvent / Water = 95/5  
Flow rate: 1 mL/min

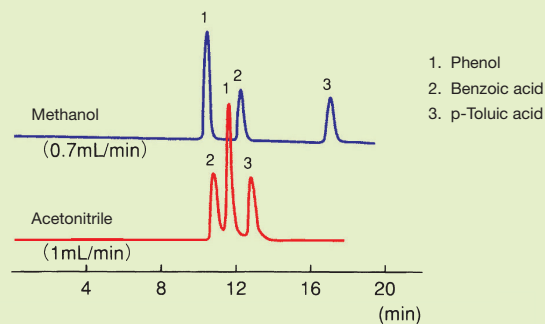

Fig. 6 Selectivity of Elution  
Column: STR ODS-II (4.6 mm I.D. X 150 mm L) X 2  
Mobile phase: Organic solvent / Sodium-phosphate buffer solution (pH 2.6) = 3/2  
Temperature: 25 °C

chromatography. We can summarize by saying that it is usually safe to use HPLC-type acetonitrile, and that methanol should be tried if the selectivity or peak shape is unsatisfactory. However, it is worth bearing in mind the various properties when establishing analysis conditions.

# Preparing Mobile Phases -Solvent Mixing Ratio-

## Mobile Phase: 50%-Ethanol Aqueous Solution How Would You Make This Solution?

In general, solvents are mixed in terms of their relative volumes (v/v) or relative weights (w/w). The volume of a solution varies with the temperature and so mixing solvents in terms of relative weights ensures a high level of reproducibility. The procedure for this is rather troublesome, however, and mixing in terms of relative volume seems to be more common. Therefore, if there is no specific indication of the mixing method (as in the above example), it is reasonable to assume that mixing is performed by relative volume. As a special case, however, note that with viscous solutions such as amine, mixing is sometimes performed in terms of weight relative to volume (w/v).

A wide variety of notational conventions for mobile phase conditions are used in literature and HPLC data. In very rare cases, precise instructions on the method used to prepare the mobile phase, such as "Add 340  $\mu$ L of phosphoric acid to 100 mL of water..." are given. Sometimes descriptions such as "20%-acetonitrile aqueous solution" or "acetonitrile : water = 40:60" are given, and sometimes descriptions containing proportions that do not add up to 100%, such as "acetonitrile/water = 21/5" or "methanol/water/phosphoric acid = 95/5/0.3" are given.

In any case, although there is no definitive notational convention for the composition of mobile phases, it is necessary to use notation that ensures mobile phases are prepared under the same conditions when performing additional analysis, and to understand this notation.

## Meaning and Preparation of "50% (v/v) Ethanol Aqueous Solution"

The description "ethanol/water = 1/1" would probably be handled using the preparation method described as "Procedure 1" on the right.

If the description were "50%-ethanol aqueous solution", most people would probably still use Procedure 1. A dictionary of chemical terms, however, would indicate that this is a case of "volume percentage", for which Procedure 2 is correct. (Refer to the table.) This means that the mobile phase compositions resulting from a percentage indication and a relative volume indication (e.g., "1:1") would be different. The density of a solvent mixture is not the same as the simple average of the densities of the original solvents and so the compositions of mobile phases created with the above methods would be different. For example, if 50 mL of water and 50 mL of ethanol were mixed together at around room temperature (25 °C), the resulting volume would only be 96 mL, not 100 mL.

In general, Procedure 1 is used widely as it is relatively simple and so it is recommended that the "AAA/BBB = 2/3" style of notation is used.

## Influence of Temperature on Solvent Volume

As mentioned before, the density of a solution is influenced by the

ambient temperature. The temperature of a solution that has just been taken out of storage is sometimes significantly lower than the ambient temperature in the laboratory, and mixtures of methanol and water become warmer due to the exothermic reaction. For this reason, in order to prepare mobile phases with a high degree of reproducibility, it is recommended that, before use, solutions are immersed in a water bath until the temperature gets close to room temperature.

## Mixing Solvents with Two Pumps

Isocratic methods that use organic solvent and water are often employed in reversed-phase analysis. With such methods, the retention times when the two types of mobile phase are delivered with (1) two pumps using a high pressure 2-liquid gradient system and then mixed in a closed system using a mixer, and (2) when the two types of mobile phase are mixed beforehand in a bottle and delivered with one pump differ due to the change in volume after mixing. Care is therefore required.

Take this opportunity to check what kind of method is used to mixed solvents in daily analysis work.

Procedure 1 - Used to Prepare (Approx.) 1 L of Mobile Phase

- 1 Measure out 500 mL of ethanol in a measuring cylinder.
- 2 Measure out 500 mL of water in another measuring cylinder.
- 3 Mix the liquids by shaking them together in a bottle, using care to vent the mixture.

Procedure 2 - Used to Prepare (Approx.) 1 L of Mobile Phase

- 1 Pour 500 mL of ethanol into a 1 L measuring flask.
- 2 Add water while agitating the flask.
- 3 The temperature of the liquid increases because of the exothermic reaction that takes place and so wait until the liquid returns to room temperature.
- 4 Add water until the total volume is 1 L.

Name	Definition
Mole percentage	$\frac{\text{Number of moles of constituent}}{\text{Total number of moles of mixture}}$
Weight percentage	$\frac{\text{Number of grams of constituent}}{\text{Total number of grams of mixture}}$
Volume percentage	$\frac{\text{Volume of constituent before mixing}}{\text{Total volume of mixture}}$

Table Methods for Indicating the Composition of Mixtures



# Preparing Buffer Solutions

The pH value of the mobile phase (eluent) is adjusted in order to improve constituent separation and extend the service life of the column. If possible, this pH adjustment should be performed using a buffer solution (liquid), rather than simply dripping an acid or a base (alkali) into the solvent. This is because it may not be possible to attain reproducibility (stability) of separation if a buffer solution is not used.

Buffer solutions are prepared by combining a weak acid and its salt (e.g., sodium salt) or a weak base and its salt. Commonly used preparation methods include 1) dripping the acid (or base) into an aqueous solution of the salt while measuring the pH value with a pH meter and 2) rendering the acid as an aqueous solution with the same concentration as the salt's aqueous solution and mixing the two while measuring the pH value with a pH meter. When using a buffer solution as an HPLC mobile phase, however, a slight error in the pH value may adversely affect the separation reproducibility and so, with preparation methods that incorporate a pH meter, the meter must be carefully inspected and calibrated. A method that does not require a pH meter is presented in the table on the right. This method involves weighing out theoretically calculated amounts of the salt and acid (or base). Some points to note regarding this method are given below.

## <Notation for Buffer Solutions>

For example, the notation "100 mM phosphoric acid (sodium) buffer solution, pH = 2.1" describes a buffer solution for which phosphoric acid is the acid, sodium ions acts as counterions, the total concentration of the phosphoric acid radical is 100 mM, and the pH value of the buffer solution is 2.1.

## <Buffering Effect Is Greatest Near Acid's (or Salt's) pKa Value>

For example, if acetic-acid (sodium) buffer solution is created from a 1:1 mixture of acetic acid and sodium acetate, the pH value of the buffer solution will be approx. 4.7, which is close to the pKa value of acetic acid, thus maximizing the buffering effect.

## <Buffering Capacity Increases with Concentration>

For example, the buffering capacity of acetic acid (sodium) buffer solution is larger at a concentration of 100 mM than it is at a concentration of 10 mM. At higher concentrations, however, there is a greater likelihood of salt crystals being formed.

## <Consideration of Salt Solubility and Deposition Required>

The solubility can vary with the type of salt (e.g., potassium salt or sodium salt). Also, there is a greater likelihood of salt crystals forming when mixed with an organic solvent.

In addition to the above, when performing high-sensitivity analysis using UV short wavelengths, avoid organic acid (carboxylic acid) buffer solutions if possible. Also, use alpha-coordinating organic acids to suppress the influence of metal ion impurities. It is necessary to consider these and other analysis conditions and to use an appropriate buffer solution.

## Preparing Buffer Solutions

<b>100 mM Phosphoric-Acid (Sodium) Buffer Solution</b>	<b>pH=2.1</b>
Sodium dihydrogen phosphate dihydrate (M.W. = 156.01) .....	50 mmol (7.8 g)
Phosphoric acid (85%, 14.7 mol/L) .....	50 mmol (3.4 mL)
Add the above to water to create a solution of volume 1 L.	
<b>10 mM Phosphoric Acid (Sodium) Buffer Solution</b>	<b>pH=2.6</b>
Sodium dihydrogen phosphate dihydrate (M.W. = 156.01) .....	5 mmol (0.78 g)
Phosphoric acid (85%, 14.7 mol/L) .....	5 mmol (0.34 mL)
Add the above to water to create a solution of volume 1 L.	
(Alternatively, dilute 100 mM phosphoric acid (sodium) buffer solution (pH = 2.1) by a factor of 10.)	
<b>50 mM Phosphoric- cid (Sodium) Buffer Solution</b>	<b>pH=2.8</b>
Sodium dihydrogen phosphate dihydrate (M.W. = 156.01) .....	40 mmol (6.24 g)
Phosphoric acid (85%, 14.7 mol/L) .....	10 mmol (0.68 mL)
Add the above to water to create a solution of volume 1 L.	
<b>100 mM Phosphoric Acid (Sodium) Buffer Solution</b>	<b>pH=6.8</b>
Sodium dihydrogen phosphate dihydrate (M.W. = 156.01) .....	50 mmol (7.8 g)
Disodium hydrogen phosphate dodecahydrate (M.W. = 358.14) .....	50 mmol (17.9 g)
Add the above to water to create a solution of volume 1 L.	
<b>10 mM Phosphoric Acid (Sodium) Buffer Solution</b>	<b>pH=6.9</b>
Sodium dihydrogen phosphate dihydrate (M.W. = 156.01) .....	5 mmol (0.78 g)
Disodium hydrogen phosphate dodecahydrate (M.W. = 358.14) .....	5 mmol (1.79 g)
Add the above to water to create a solution of volume 1 L.	
(Alternatively, dilute 100 mM phosphoric acid (sodium) buffer solution (pH = 6.8) by a factor of 10.)	
<b>20 mM Citric Acid (Sodium) Buffer Solution</b>	<b>pH=3.1</b>
Citric acid monohydrate (M.W. = 210.14) .....	16.7 mmol (3.51 g)
Trisodium citrate dihydrate (M.W. = 294.10) .....	3.3 mmol (0.97 g)
Add the above to water to create a solution of volume 1 L.	
<b>20 mM Citric Acid (Sodium) Buffer Solution</b>	<b>pH=4.6</b>
Citric acid monohydrate (M.W. = 210.14) .....	10 mmol (2.1 g)
Trisodium citrate dihydrate (M.W. = 294.10) .....	10 mmol (2.94 g)
Add the above to water to create a solution of volume 1 L.	
<b>10 mM Tartaric Acid (Sodium) Buffer Solution</b>	<b>pH=2.9</b>
Tartaric acid (M.W. = 150.09) .....	7.5 mmol (1.13 g)
Sodium tartrate dihydrate (M.W. = 230.08) .....	2.5 mmol (0.58 g)
Add the above to water to create a solution of volume 1 L.	
<b>10 mM Tartaric Acid (Sodium) Buffer Solution</b>	<b>pH=4.2</b>
Tartaric acid (M.W. = 150.09) .....	2.5 mmol (0.375 g)
Sodium tartrate dihydrate (M.W. = 230.08) .....	7.5 mmol (1.726 g)
Add the above to water to create a solution of volume 1 L.	
<b>20 mM (Acetic Acid) Ethanolamine Buffer Solution</b>	<b>pH=9.6</b>
Monoethanolamine (M.W. = 61.87, d = 1.017) .....	20 mmol (1.22 mL)
Acetic acid (glacial acetic acid, 17.4 mol/L) .....	10 mmol (0.575 mL)
Add the above to water to create a solution of volume 1 L.	
<b>100 mM Acetic Acid (Sodium) Buffer Solution</b>	<b>pH=4.7</b>
Acetic acid (glacial acetic acid, 99.5%, 17.4 mol/L) .....	50 mmol (2.87 mL)
Sodium acetate trihydrate (M.W. = 136.08) .....	50 mmol (6.80 g)
Add the above to water to create a solution of volume 1 L.	
<b>100 mM Boric Acid (Calium) Buffer Solution</b>	<b>pH=9.1</b>
Boric acid (M.W. = 61.83) .....	100 mmol (6.18 g)
Potassium hydroxide (M.W. = 56.11) .....	50 mmol (2.81 g)
Add the above to water to create a solution of volume 1 L.	
<b>100 mM Boric Acid (Sodium) Buffer Solution</b>	<b>pH=9.1</b>
Boric acid (M.W. = 61.83) .....	100 mmol (6.18 g)
Sodium hydroxide (M.W. = 40.00) .....	50 mmol (2.00 g)
Add the above to water to create a solution of volume 1 L.	

# pKa and Dissociation Equilibrium

## 1. pH

Adding acid, such as hydrochloric acid, to water reduces the pH value. The degree of acidity of a solution is determined by the concentration ( $[H^+]$ ) of the protons (hydrogen ions) and the pH value is a simple way of representing  $[H^+]$ . The pH value is expressed by the following formula; it can be seen that the pH value gets smaller as the degree of acidity (i.e., the proton concentration) increases.

$$pH = -\log_{10}[H^+] \text{ (Refer to the note at the end.)}$$

Note that a difference of 1 in the pH value corresponds to a 10-fold increase/decrease in the proton concentration.

## 2. pKa and Dissociation Equilibrium

Some acids (strong acids) completely dissociate when dissolved in water whereas some acids (weak acids) only partly dissociate. When an acid dissociates, protons are released and the solution is acidified. With weak acids, a dissociation equilibrium between the dissociated state ( $A^-$ ) and undissociated state ( $AH$ ) is reached. This equilibrium is represented by the following expression.

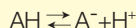

Under constant conditions, the ratio between the concentrations of the two sides is constant; this constant is called the "acid dissociation constant" ( $K_a$ ).  $K_a$  is defined by the following equation.

$$K_a = \frac{[A^-][H^+]}{[AH]}$$

The  $[ ]$  expressions represent the concentrations of the constituents. From this equation, it can be seen that the ease with which protons are discharged from an acid (i.e., the strength of the acid) is expressed by  $K_a$ , and also the dissociated state of weak acids varies with the value for  $[H^+]$  in the solution.

The  $K_a$  value for carboxylic acids (i.e., acids with  $-COOH$  in the formula), such as acetic acid and lactic acid, is usually in the range  $10^{-3}$  to  $10^{-6}$  and so the  $K_a$  value as it stands can be complicated and difficult to grasp intuitively.

In answer to this, "pKa" is used to express the strength of weak acids. pKa is defined by the following equation.

$$pKa = -\log_{10}K_a$$

For example, the  $K_a$  value for acetic acid ( $CH_3COOH$ ) is 0.0000158 ( $= 10^{-4.8}$ ) whereas the pKa value is 4.8, a much simpler figure. The pKa value is smaller for stronger acids. For example, the pKa value for lactic acid is approx. 3.8, indicating that it is a stronger acid than acetic acid.

## 3. pKa and Buffering Capacity

Another important point is the relationship between the pH value of a solution and the pKa value of an acid. This relationship is expressed by the following equation.

$$pH = pKa + \log_{10} \frac{[A^-]}{[AH]}$$

This equation can be used to obtain the following equation.

$$\frac{K_a}{[H^+]} = \frac{[A^-]}{[AH]}$$

If the pKa and pH values are the same, this equation indicates that the acid is precisely half dissociated ( $[A^-] / [AH] = 1$ ). Also, if the pH value changes by 1 above or below the pKa value, the acid's dissociated state changes greatly. For example, in the case of acetic acid, if the pH value changes near 4.8, the abundance of acetic acid changes greatly, as shown in the figure below. For a pH value of 3.8, at least 90% consists of acetic acid ( $CH_3COOH$ ), whereas for a pH value of 5.8, at least 90% consists of acetic acid ions ( $CH_3COO^-$ ).

Conversely, to change the pH value close to the acid's pKa value, the dissociated state of the acid must be changed greatly, and consequently a large amount of the acid or its base is required. The behavior of a solution whereby it tends to maintain the same pH value is referred to as its "buffering capacity". The smaller the difference between the pKa and pH values, the larger the buffering capacity. In the selection of buffer solutions, which are often used in liquid chromatography, acids and bases with pKa values close to the desired pH values are chosen in order to utilize this buffering capacity.

\* Although the activity, rather than the concentration, must be used, the concentration and activity correspond closely at the analysis concentration and so the concentration was used instead of the activity. (Same applies below.)

Fig. Relationship between pH of Solution and Dissociated State of Acetic Acid

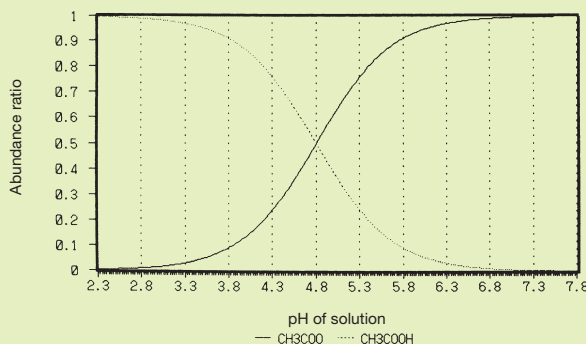

# Water Grade

Water is one of the most important solvents used in liquid chromatography. At present, various grades of water, corresponding to different applications, are commercially available. Various types of water purification systems are also manufactured. In addition to the purity of the water, consideration is also required of the chemical properties of residual impurities, including whether they are organic or inorganic, ionic or nonionic, and UV absorbent or non-UV absorbent. The application varies according to these factors. Here we will look at some points related to the grade of the water used in liquid chromatography.

## Water Used in Liquid Chromatography

Distilled water specifically for HPLC is commercially available. As is indicated on the container's label, this is intended for UV detectors, which are used for HPLC in many different ways. UV-absorbent organic matter is removed via distillation or some other method and, in particular, absorbance in the short-wavelength region is assured. Therefore, it is advisable to use this grade of water as the mobile phase when performing high-sensitivity analysis using a UV detector. This is particularly noticeable with gradient elution in reversed-phase separation mode. This is because the organic matter in the first liquid, which has a low elution capacity, is easily concentrated in the column, and as gradient elution proceeds, ghost peaks and increasing drift in the baseline appear. The figure below shows the baseline for the gradient going from 100% water to 100% acetonitrile in analysis using water with a low level of purity. As gradient elution progresses, many ghost peaks start to appear. Even with water purification systems, if the level of purification is low, or if maintenance is insufficient and organic matter remains in the water, the same problem can occur and so care is required.

When performing measurement in the long-wavelength region of a UV (or VIS) detector, or when using another HPLC detector, such

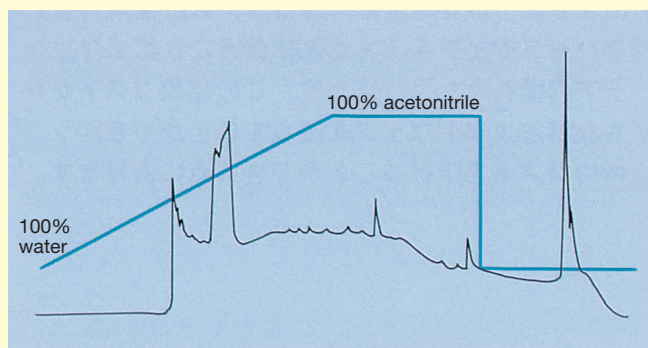

Fig. Baseline at 200 nm for water → acetonitrile gradient

as a refractive index detector, spectrofluorometric detector, or conductivity detector, distilled water for HPLC is not necessarily the optimum choice. Of course, because it has a high level of purity, there are no problems in actual use. It may simply be unnecessarily expensive.

In amino acid analysis and ion chromatography, for reasons related to the fact that 100% buffer solution is used as the mobile phase, the role of water is extremely important and so the following points are observed.

## Water for Analyzing Amino Acids

In the high-sensitivity analysis of amino acids performed via the post-column derivatization of amino groups with o-phthalaldehyde or ninhydrin, contamination of the solvents or mobile phase with amines or ammonia may cause ghost peaks and rises in the baseline (“ammonia plateau”) and so care is required. Ammonia may be dissolved in water that has been left exposed to air for some time, and there may be amines left in water with a low level of purification. Therefore, in amino-acid analysis, it is better to use fresh water that, if possible, has been further purified using distillation. Using a Shimadzu amino acid kit saves preparation time and ensures a consistent analysis.

## Water for Ion Chromatography

In ion chromatography, ion contamination in the mobile phase solvent can cause noise and baseline fluctuation. Also, a “system peak” phenomenon can occur, with ghost peaks and negative peaks appearing in the baseline, and the accuracy of quantitative values can be adversely affected. Therefore, care is required. In general, ion-exchange water with a low residual ion content and, as a rough guide, a conductivity not exceeding  $1\mu\text{S}/\text{cm}$  (specific resistance no less than  $1\text{M}\Omega/\text{cm}$ ) is considered appropriate for the mobile phase. Also note that carbonate ions are present at ppm-level concentrations in commercial distilled water for HPLC and water that has been left exposed to air for some time, and also sodium ions are eluted if water is preserved in glass containers.

As described above, consideration of the grade of water used in liquid chromatography, based on an awareness of the analysis purpose, is required. It goes without saying that consideration of the grade of any organic solvent also used is required.

## Gradient Baseline for Acetonitrile Containing TFA

Gradient elution (GE) with water/acetonitrile containing trifluoroacetic acid (TFA) is often used for the analysis and fraction collection of peptides and proteins. In this process, drift and ghost peaks are liable to appear in the baseline, and there are cases where it is difficult to decide how to perform data processing. Here, we will take another look at this problem.

Fig. 1 shows a 3D chromatogram obtained by performing GE using 0.01 M TFA aqueous solution (liquid A) and 0.01 M TFA acetonitrile solution (liquid B), going from 0% to 100% concentration of liquid B. Here we can observe a peak (A) at around the time at which liquid B first reaches the detector, a rise (B) and a drop (C) at around 200 nm, and a rise (D) at around 225 nm that corresponds to the increasing volume of liquid B.

Fig. 2 shows the result of removing the column and performing GE with just the tubing. One major difference is that Peak A, shown in Fig. 1, has gone. We can conclude that this peak was produced by the elution of TFA and impurities in the mobile phase retained inside the column. On the other hand, it can be concluded that B, C, and D occurred at a more fundamental level. The chromatograms used to check the data for Fig. 2 are shown in Fig. 3. At around 215 nm, the baseline fluctuation is small. With short wavelengths, the baseline rises before dropping down to negative values. With long wavelengths, the baseline describes a concave path moving upwards.

It would seem then that performing measurement at 215 nm would be fairly problem-free, but this is not necessarily the case. The chromatograms shown in Fig. 4 were obtained using a measurement wavelength of 215 nm, but the wavelength bandwidth was changed. Note that the baseline fluctuates quite a lot when the wavelength bandwidth is increased. Around 215 nm, the change in absorbance at the short-wavelength end is larger than the change at the long-wavelength end (Fig. 5) and so the effect is like a shift to the short-wavelength end. The wavelength bandwidth for a standard single wavelength UV-VIS detector is around 8 nm and so care is required when performing GE to liquid-B concentrations exceeding 50%.

Let us check the spectra for liquids A and B. Even though both contain TFA at the same concentration (0.01M), the spectra differ greatly, as shown in Fig. 6. Therefore, the changes in the GE base that have been mentioned occur mainly because of changes in the spectra for the liquids themselves, rather than because of the way in which they were mixed.

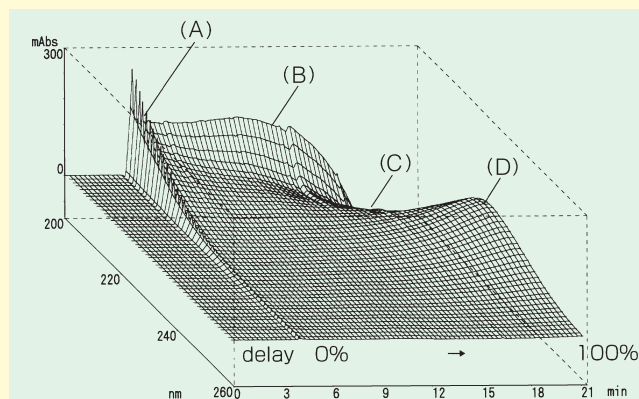

Fig. 1 GE Baseline Obtained with Water/Acetonitrile Containing TFA  
Column: ODS

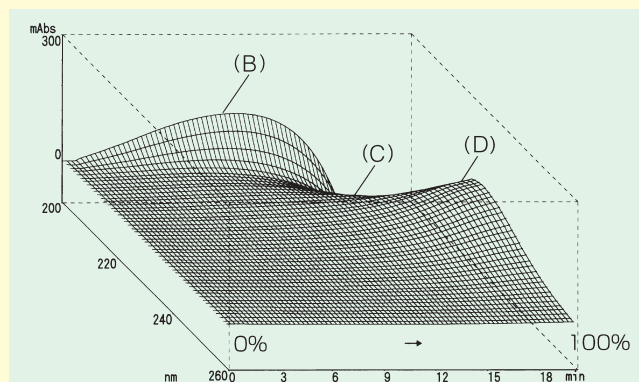

Fig. 2 GE Baseline Obtained with Water/Acetonitrile Containing TFA  
Column: None

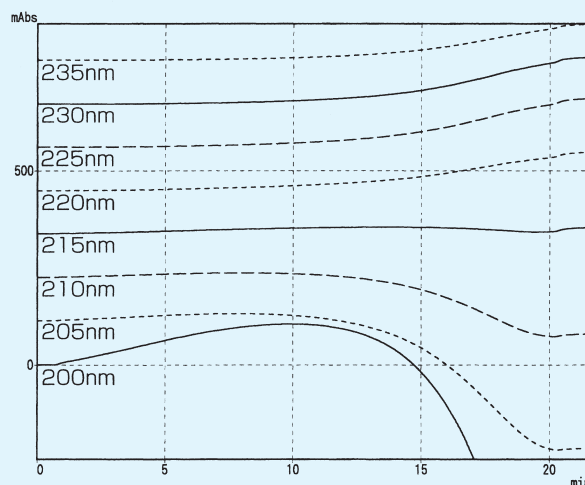

Fig. 3 GE Baseline Obtained with Water/Acetonitrile Containing TFA  
Same conditions as Fig. 2.

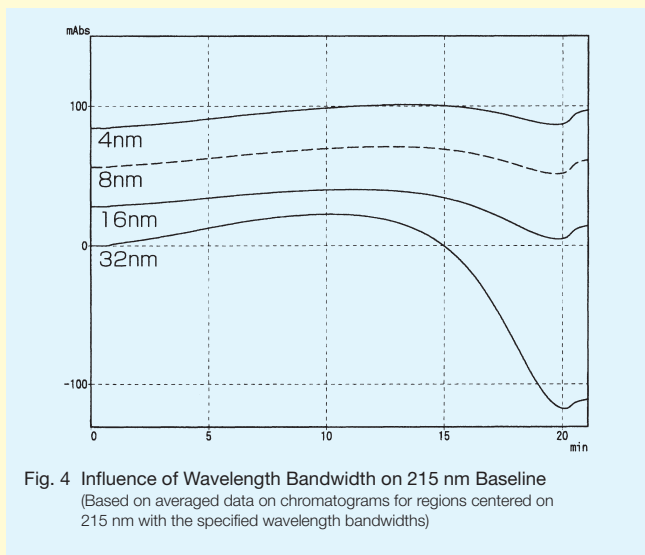
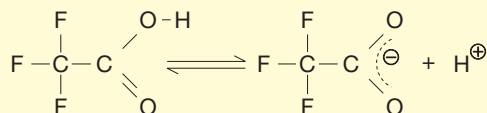

Fig. 4 Influence of Wavelength Bandwidth on 215 nm Baseline  
(Based on averaged data on chromatograms for regions centered on 215 nm with the specified wavelength bandwidths)

Why do the absorption spectra change when the proportion of acetonitrile increases? There are various possible causes. One is the suppression of TFA dissociation. Another is mutual interaction between TFA and acetonitrile.

We performed an experiment in which we tried to maintain the dissociated state of TFA as much as possible. Instead of water, TFA dissolved in 0.1 M phosphoric acid (sodium) buffer solution (pH 2.1) was used as the solvent for liquid A. (As shown in Fig. 6, the spectra for this solution are almost the same as the ones obtained with water as the solvent.) GE was performed going from 0% to 70% concentration of liquid B. Irregular fluctuations in the baseline were not observed in the results, which are shown in Fig. 7. Therefore, it can be concluded that the changes in the spectra are mainly due to changes in the dissociated state of TFA. (If the acetonitrile percentage is high, the equilibrium shown below shifts to the left.)



If GE is performed with an organic acid, such as acetic acid, without using TFA, a similar form of baseline fluctuation occurs. Before assuming that there is a problem, first consider whether or not this fluctuation is acceptable and whether or not it presents a problem with regard to qualitative and quantitative analysis.

Reference

G. Winkler et al, *J. Chromatogr.*, 347 (1985) 83-88

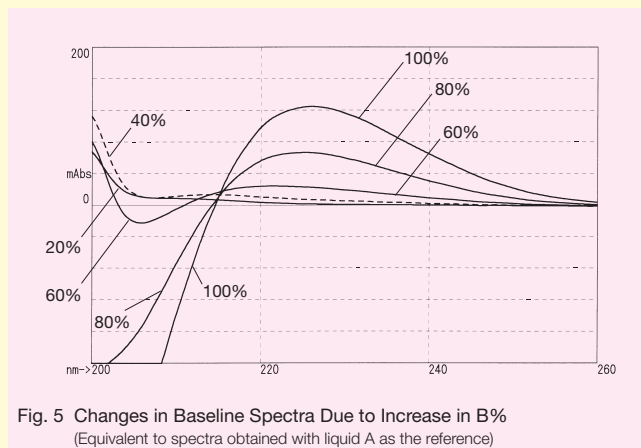

Fig. 5 Changes in Baseline Spectra Due to Increase in B%  
(Equivalent to spectra obtained with liquid A as the reference)

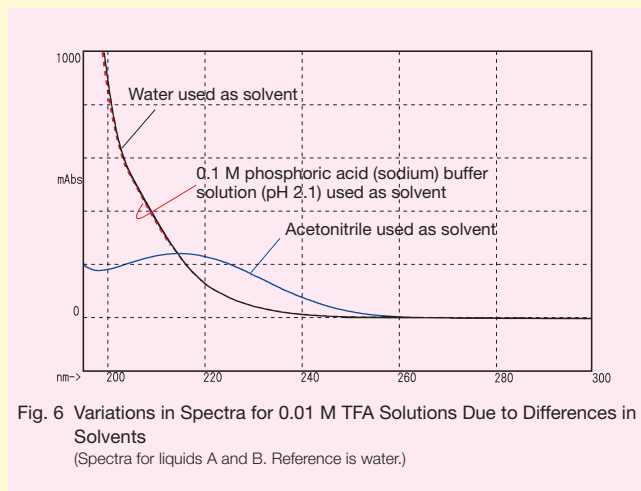

Fig. 6 Variations in Spectra for 0.01 M TFA Solutions Due to Differences in Solvents  
(Spectra for liquids A and B. Reference is water.)

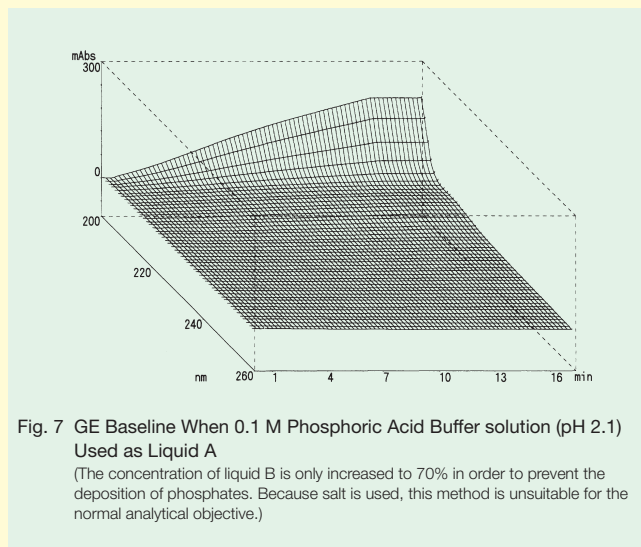

Fig. 7 GE Baseline When 0.1 M Phosphoric Acid Buffer solution (pH 2.1) Used as Liquid A

(The concentration of liquid B is only increased to 70% in order to prevent the deposition of phosphates. Because salt is used, this method is unsuitable for the normal analytical objective.)

# Ion-Pair Chromatography -Choosing between Alkyl Sulfonate and Perchloric Acid-

Ion-pair chromatography (IPC) is a technique for separating charged matter and is used widely as a selective analysis method for acids and bases, especially in reversed-phase chromatography. However, analysts often complain, for example, about the difficulty of setting analysis conditions for IPC, and that a satisfactory level of reproducibility cannot be attained. These problems probably occur because of insufficient consideration of the selection of and usage conditions for counterions (ions having a charge opposite to that of the target constituent) added to the mobile phase. Here, we will use alkyl sulfonate and perchloric acid, which are often used in the IPC of salts and cations, as examples, consider their characteristics, and look at some key points related to their selection.

## Alkyl Sulfonate

Alkyl sulfonate ions are typical counterions used for the IPC of positively charged matter and, usually, those with a carbon number in the range 5 to 12 are used as sodium salts. In general, the separation mechanism in reversed-phase ion-pair chromatography is usually explained in terms of two processes: the ion-pair distribution process where the target component forms ion pairs together with the counterions and is taken into the stationary phase; and the ion-exchange process where the target constituent undergoes ionic interaction with counterions that were hydrophobically adsorbed by the stationary phase and is retained. With alkyl sulfonate, however, the ion-exchange process can be considered as the main mechanism. For this reason, the constituent-retention effect increases with the alkyl sulfonate carbon number and, for the same type of alkyl sulfonate, the retention strength is higher for lower concentrations of the organic solvent in the mobile phase. (If a type of alkyl sulfonate with a high carbon number is used under conditions where the organic solvent concentration is extremely low, a quasi-ion-exchange mode is entered, and once equilibrium is reached, it is possible to retain the target constituent without adding counterions to the mobile phase.) The concentration of the counterions also affects constituent retention but with a surface-active agent such as alkyl sulfonate, there is a special relationship between the concentration and the retention behavior. This is shown in Fig. 1. In the low concentration region, target retention increases in a linear fashion, but saturation occurs at a certain concentration (called the "fold-over point"), and target retention starts to fall beyond this point. This is explained as the result of alkyl sulfonate forming micelles and a second hydrophobic phase being created in the mobile phase. Therefore, the counterion concentration that can be used for IPC is limited to a certain range.

## Perchloric Acid

Unlike alkyl sulfonate, perchloric acid (normally used as a sodium salt) is not hydrophobic in itself and so there is no possibility of achieving any kind of ion-exchange effect. It does, however, have a large ionic radius and easily forms ion pairs, and so the separation mechanism for IPC can be thought of as consisting almost entirely

of the ion-pair distribution process. For this reason, there is no fold-over point between the concentration and constituent retention, and the retention gradually increases with the concentration. Furthermore, regardless of the organic solvent's concentration, the constituent-retention effect is uniform.

However, because the constituent-retention effect attained with perchloric acid derives from the hydrophobic properties of the constituent itself that is exhibited when charge is lost due to pair formation, depending on the constituent, there may be cases where it cannot be applied.

## Selection of Counterions

Let us take a look at the ways in which these counterions are selected in accordance with their characteristics. The purpose of IPC that uses these counterions is basically to increase the retention of bases and cations but it is also used to suppress peak tailing (a phenomenon that is prone to occur with, for example, silica gel columns incorporating ODS). Alkyl sulfonate is better for controlling constituent retention over a wide range and is therefore more suitable for the former purpose. On the other hand, perchloric acid is more suitable for the latter purpose as it is more convenient and can be applied to any constituent. Therefore, the choice between alkyl sulfonate and perchloric acid is usually based on a choice between constituent retention and tailing suppression. However, if the hydrophobic ions belong to the target constituent, the large difference between alkyl sulfonate and perchloric acid disappears.

When using alkyl sulfonate, the concentration of the organic solvent in the mobile phase becomes an important factor in deciding on an appropriate carbon number. In order to elute the constituent in a certain position with a constant organic solvent concentration, higher concentrations must be set for smaller carbon numbers. As shown in Fig. 1, however, there is a limit on the counterion concentration, and low carbon numbers cannot be used if the organic solvent concentration is high. On the other hand, it is not necessarily true to say that using a high carbon number is desirable in terms of the counterions. From the perspective of column equilibrium, a lower carbon number is advantageous. The time taken to reach equilibrium is longer for lower organic solvent concentrations and counterion concentrations. If a type of alkyl sulfonate with a high carbon number is used with a low organic solvent concentration, this naturally entails low concentration use and so a considerable amount of time is required for column stabilization. Therefore, it is important to decide the organic solvent concentration before selecting the carbon number. Fig. 2 provides rough guidelines on the effective usage conditions for counterions (i.e., counterion concentrations and organic solvent concentrations). Use it as reference for counterion selection.

## Setting the Organic Solvent Concentration

When setting the organic solvent concentration, it is first necessary to consider the hydrophobic properties of the target constituent

itself. This involves considering the extent to which the constituent is retained with a mobile phase not containing any counterions. For example, in order to elute the constituent with IPC in 10 minutes, it must be necessary for elution to take place within 10 minutes without any counterions. Therefore, taking the organic solvent concentration giving a retention time in this state of 10 minutes as a lower limit, it is necessary to set a concentration no lower than this. If IPC is used simply for the purpose of increasing retention of the constituent, any

suitable concentration no lower than this limit can be set but, when separating constituents that have similar hydrophobic properties, the relative retention is lower for higher organic solvent concentrations and so it is desirable to select a concentration as close as possible to the lower limit. Also, the upper limit when analyzing bases or cations, or even neutral substances or acids, is the concentration at which these can be appropriately retained.

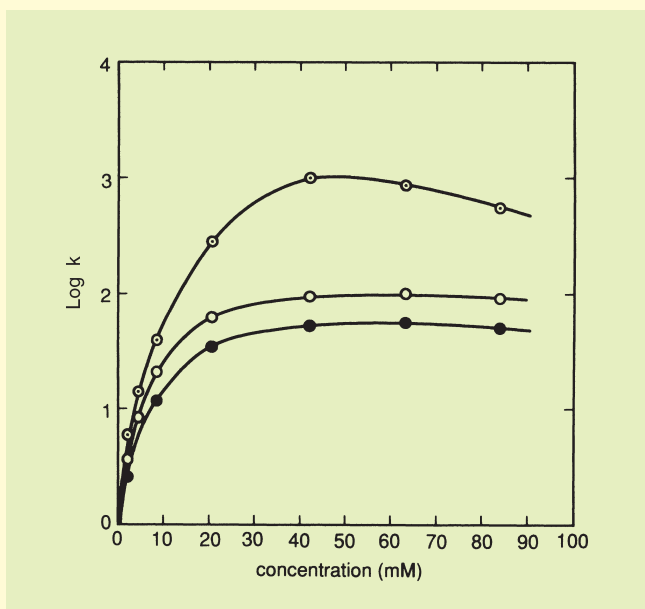

**Fig. 1 Influence of Ion Concentration on Constituent Retention**  
 Analysis Conditions  
 Column: STR ODS-M  
 Mobile phase: 10 mM citric acid (sodium) buffer solution (pH 4.6) containing sodium 1-octanesulfonate / acetonitrile = 5/1 (v/v)  
 Flow rate: 1.0 mL/min  
 Column temperature: 40°C  
 Detection: UV, 280 nm  
 Constituents: ● Norepinephrine, ○ Epinephrine, ⊙ Dopamine

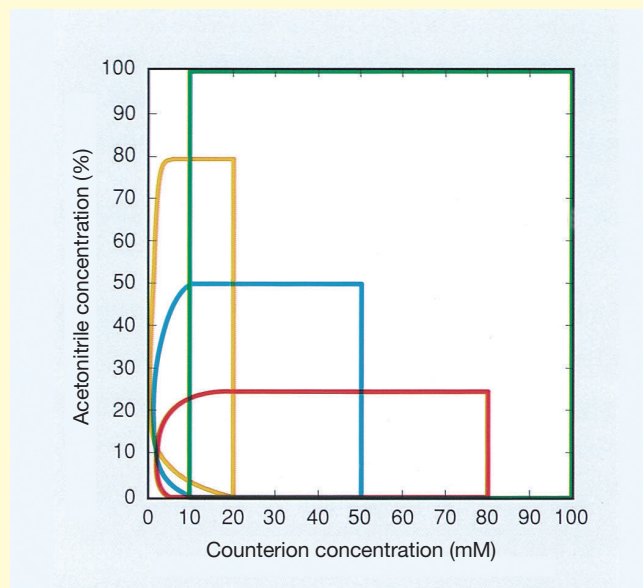

**Fig. 2 Counterion and Organic Solvent (Acetonitrile) Concentration Ranges for Which Effective Ion-Pair Chromatography Can Be Expected**  
 Red: Hexanesulfonic acid Blue: Octanesulfonic acid  
 Yellow: Decanesulfonic acid Green: Perchloric acid

# Measuring Accurately with Electronic Balances

Electronic balances have developed rapidly and now represent the mainstream of analytical balances. This is because they offer many advantages that were not available with mechanical balances. For example, they allow anyone to perform measurement simply and quickly, they can be used to create printed records of measurement results, and they have many optional functions. Even with these handy electronic balances, though, care is required to ensure accurate measurement. Here, we will be looking at some points related to this.

## Differences Between Mechanical Balances and Electronic Balances

As previously mentioned, electronic balances offer many advantages. They do have a disadvantage, however, that was not a problem with mechanical balances, and that is that their sensitivity is affected by changes in temperature. With conventional mechanical balances, such as direct-reading balances and geometric balances, the mass of a sample is measured by balancing it with a weight. On the other hand, with electronic balances, the mass of a sample is measured by balancing it with the electromagnetic force that is generated between a permanent magnet and a coil. The weight of this electromagnetic force is not stable in the way a weight used in a mechanical balance is. More specifically, a change in temperature causes a change in the electromagnetic force and this manifests itself as a change in sensitivity.

## Sensitivity Calibration and Calibration Weights for Electronic Balances

Since the sensitivity of electronic balances changes if the temperature changes, the sensitivity must be calibrated. The timing and frequency with which the sensitivity should be calibrated depend on the season and the use of heating/cooling equipment. The following gives a very rough guide for appropriate calibration frequencies, classified according to the number of display digits.

5-digit display (e.g., 300 g/10 mg): Once a week

6-digit display (e.g., 300 g/1 mg): Once a day

7-digit display (e.g., 200 g/0.1 mg): Every time it is used

Sensitivity calibration must also be performed whenever the location of the balance is changed.

One point requiring caution is that the weights used do not necessarily have the level of precision required for calibration. Even the most precise, top-grade commercial weights (e.g., a 100 g weight with a tolerance of 4 mg) may not be sufficient for the calibration of an electronic balance. For this reason, electronic balances with built-in calibration weights are a convenient alternative.

Changes in the sensitivity of an electronic balance cannot be gauged simply by looking at a thermometer hanging on the wall. This is because the internal temperature of the balance takes time to conform to the ambient temperature. For this reason, as mentioned earlier, electronic balances with 7-digit displays

need to be calibrated every time they are used. This effort can be avoided by using an electronic balance equipped with a function that checks the internal temperature and performs a complete automatic calibration when required.

## Samples and Sample Containers

When using an electronic balance with a reading limit of less than 0.1 mg, the temperature of the sample and sample container must be close to the temperature inside the sample compartment. Otherwise, the reading may change even if though there is no change in the sample mass. (See Fig. 1.) The graph in Fig. 2 shows how the reading of the balance changes over time when a sample container at a temperature different to that inside the sample compartment is placed on the balance. It can be seen that the influence of convection and changes in air density that result from the temperature difference cannot be ignored. The worst scenario is where the sample volume is small but the sample container is large, as is the case when measuring the change in mass of a small quantity of sample inside a beaker. In order to check for errors, measure an empty beaker under the same conditions as the beaker containing the sample before and after measuring the change in the sample mass. If the reading for the mass of the empty beaker is the same before and after measuring the change in the sample mass, then it is reasonable to conclude that measurement was performed correctly. If there seems to be an error, place the sample and sample container inside the sample compartment, close the doors tightly, and wait until the temperature difference has gone before performing measurement.

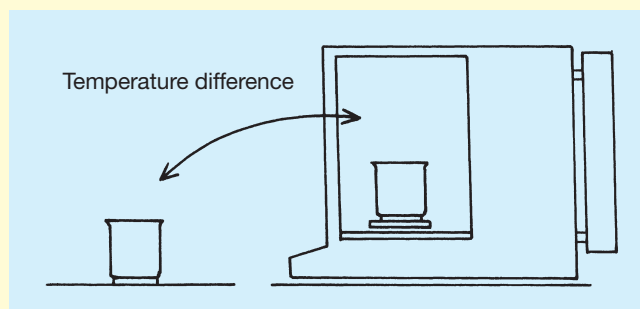

Fig. 1 When a sample at a different temperature is placed on the balance...



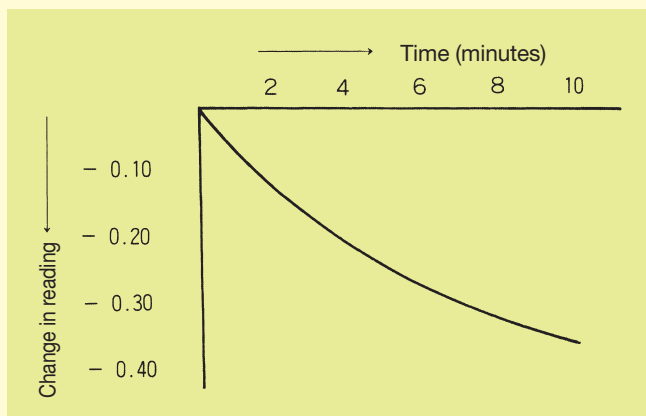

Fig. 2 ...the reading changes over time.

### Sample Density

The measurement result obtained with an accurately calibrated electronic balance does not necessarily give the correct weight. The mass is measured correctly only when the sample density is  $8.0 \text{ g/cm}^3$ . This is because the buoyancy for the calibration weight and the sample are different. Also, changes in temperature result in changes in the air density, and this in turn changes the influence of buoyancy. Therefore, even if the sample is measured with an accurately calibrated balance, if the density is not  $8.0 \text{ g/cm}^3$ , the measurement results will vary with the ambient temperature. Compensation for the effects of buoyancy is particularly necessary when measuring mass changes in samples (or sample containers) with a low density and a large volume.

### Influence of Static Electricity

If the ambient humidity is low, static electricity may build up on the sample and sample container, and this may result in the balance readings becoming unstable, changing each time the sample is placed on or taken off the balance. When working with a sample or sample container composed of a highly insulating material, establishing whether a problem is due to the influence of static electricity or due to a fault in the balance can be performed easily, compared to a highly conductive material.

In order to inhibit the buildup of static electricity, ensure that the ambient humidity does not drop below, say, 60%.

Also, if static electricity does build up on the sample or sample container, it may still be possible to obtain satisfactory results by covering with metal such as aluminum foil.

### Top-Loading Electronic Balances Used for Analysis

Nearly all conventional mechanical balances with a reading limit of 0.1 mg or less were bottom-loading. Electronic balances, however, even ones in this class, are mostly top-loading. Top-loading balances offer superior operability but they do have a disadvantage in that the measurement result may vary depending on where the sample is positioned on the pan. The size of the error depends on the balance but it is something that should be checked beforehand.

**Please take this opportunity to check all the points mentioned here, even for balances that you are accustomed to using on a daily basis, and always strive to ensure correct measurements.**

# Causes of Quantitative Errors Originating in Sample Preparation

The process of performing analysis using HPLC can be divided into sample preparation, injection, separation, detection, and data processing. The causes of quantitative errors may originate in any of these stages but here we will be looking at those related to sample preparation.

## Preparation of Standard Solutions

There is a tendency for this aspect to be considered lightly. As shown in Table 1, there are many points that require attention. Out of these, “adsorption of target constituent to container” (K) is particularly important. Some examples are shown in Table 2. There are cases where adsorption can be inhibited by selecting an appropriate solvent, and there are also cases where a container made of a different material must be used. Adsorption may also be detected from a lack of linearity in the calibration curve (or failure of

the curve to pass through the origin) that occurs when the solution is diluted.

“Oxidation or decomposition of target constituent” (N) is also important. For example, ascorbic acid is easily oxidized by dissolved oxygen and iron (III) ions in aqueous solutions, and the concentration drops over time. In this case, measures such as lowering the pH and masking the iron ions with EDTA-2Na are recommended. It is also recommended that injection is performed immediately after preparation. In general, oxidation and decomposition are inhibited by, for example, adding a reducing agent, performing nitrogen substitution, using a non-aqueous solvent, using a brown bottle, or storing in a dark, cold places. Oxidation and decomposition can also be detected from a reduction in area value that occurs when the sample solution is injected several times.

Table 1 Preparation of Standard Solutions

	i) Measure the weight of the standard substance.	ii) Add solvent to create a solution.	iii) Preserve the solution.
Operation			
Item where error originates	<ul style="list-style-type: none"> <li>(A) Insufficient accuracy of balance</li> <li>(B) Mistake in weighing procedure</li> <li>(C) Impurities</li> <li>(D) Undetermined hydrates</li> <li>(E) Hygroscopic properties</li> </ul>	<ul style="list-style-type: none"> <li>(F) Insufficient accuracy of apparatus</li> <li>(G) Mistake in volume-adjustment procedure</li> <li>(H) Mistake in dilution operation</li> <li>(I) Insufficient solubility (Temperature changes also considered.)</li> <li>(J) Uneven solution (turbidity, fluctuations)</li> <li>(K) Adsorption of target constituent to container</li> <li>(L) Commingling between target constituent and container or atmosphere (special case)</li> </ul>	<ul style="list-style-type: none"> <li>(M) Evaporation of solvent</li> <li>(N) Oxidation or decomposition of target constituent</li> </ul>



Table 2 Possible Ways in Which the Target Constituent Adsorbs to the Container

Material	Examples of easily adsorbed constituents	Measures used to inhibit adsorption
Glass	Cations (quaternary ammonium, metal ions) Amines	<ul style="list-style-type: none"><li>● Lower the pH.</li><li>● Add perchloric acid ions.</li><li>● Add competing ions.</li></ul>
Metal	Anions (organic acid, $\beta$ -diketone, tropolone) Chelate-forming constituents	<ul style="list-style-type: none"><li>● Add competing ions.</li><li>● Lower (or in some cases, raise) the pH.</li><li>● Add masking agent.</li></ul>
Polymer	Highly hydrophobic constituents	<ul style="list-style-type: none"><li>● Reduce the polarity.</li></ul>

### Pretreatment of Actual Samples

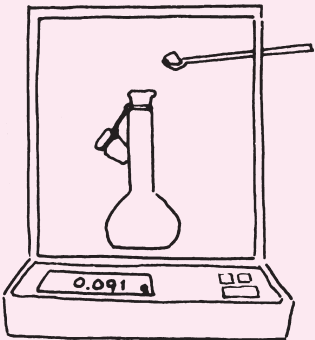
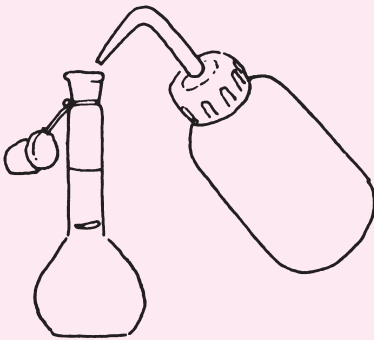
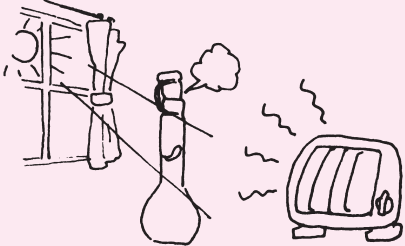
The problem of the extraction recovery rate must be considered with this procedure. In solid-liquid extraction (incorporating a pretreatment column) and liquid-liquid extraction, it may not be possible to attain a high recovery rate or the recovery rate may be unstable. In protein removal, the target constituent may adsorb to degenerated protein, causing a reduction in the recovery rate. Normally, the recovery rate is evaluated by adding the target constituent to the sample and extracting it. The change in the relationship between the amount of target constituent added and the increase in the peak area in the chromatogram compared to when the target-constituent solution is injected without extraction is investigated.

If there is a problem in the recovery rate, either the extraction method is changed, or extraction is performed after adding an internal standard. In this case, the internal standard must have a similar chemical structure to the target constituent and the extraction efficiency must be approximately the same. (Refer to page 26.) Pretreatment is often performed with this method in cases where the recovery rate is not 100% but a relatively stable rate can be attained.

Always strive for a high level of accuracy in daily analysis work by considering the potential causes of errors that require particular attention as well as the possibility that some kind of problem is currently occurring.

# Peaks Caused by Dissolved Air in Sample Solvents

Peaks of unknown origin (ghost peaks) sometimes appear in HPLC analysis. These can be particularly troublesome when testing pharmaceuticals for impurities. There are various causes of ghost peaks but one possible cause that is often overlooked is dissolved air in the sample solvent. Here, we will look at this issue in the context of reversed-phase separation and UV detection.

## 1. Appearance of Peaks Possibly Caused by Dissolved Air (Oxygen)

If the type and composition of the organic solvent differ between the sample solution and the mobile phase, it can be predicted that some form of peak will appear. There are also cases, however, where peaks appear when the mobile phase is injected as the sample solution. When this is retained and eluted, it makes the analyst wonder what on earth it could be. One possible cause of this is a difference in the amount of dissolved air (or, particularly with UV detection, dissolved oxygen).

Fig. 1 shows the results obtained by injecting the mobile phase as the sample, where the mobile phase consists of a mixture of methanol and water, and is degassed online. Injection was performed after changing the concentration of dissolved oxygen and the results were compared. When the sample (mobile phase) was injected in the normal state, namely, saturated with air, a peak appeared. (Labeled a) in Fig. 1. Approx. 10 mAbs when 10  $\mu$ L was injected.) This peak almost completely disappeared (labeled b) in Fig. 1) when the sample was injected after performing a helium purge. (The concentration of dissolved oxygen was close to zero). The peak was much bigger (labeled c) in Fig. 1) when the sample was injected after performing an oxygen purge. (The concentration of dissolved oxygen was approx. five times that of the air-saturated state.)

On the other hand, when the mobile phase was not subjected to online degassing, hardly any peak appeared when the sample was injected in the air-saturated state. (Labeled a) in Fig. 2.) A negative peak was observed when a helium purge was performed. (Labeled b) in Fig. 2.) It can be concluded from these results that differences in the amount of dissolved oxygen in the mobile phase and the sample solution can result in the appearance of peaks.

## 2. Size of Peaks

We will now consider the peak size. Fig. 3 shows a comparison of spectra obtained for air-saturated (i.e., not degassed) methanol and degassed methanol. When methanol is degassed, the absorbance is reduced. The difference in absorbance depends on the wavelength. At 210 nm, it exceeds 300 mAbs whereas at 254 nm, it is approx. 10 mAbs. Using these values, a simple calculation is performed to obtain the peak height for the case where air-saturated methanol is injected into degassed methanol.

With a flow rate of 1 mL/min and an injection volume of 10  $\mu$ L, if we view the peak as a triangle with the base corresponding to period of 0.4 minutes, the peak height at 210 nm exceeds 15 mAbs and the peak height at 254 nm is approx. 0.5 mAbs. We can see that the peaks are quite large at short wavelengths.

What about other solvents? Fig. 4 shows differential spectra for different types of solvent, obtained by subtracting the spectra for the degassed state from spectra for the air-saturated state. The absorbance of each of the solvents is increased by the dissolved air. The influence of dissolved air is small for water and acetonitrile and large for hexane, methanol, and THF.

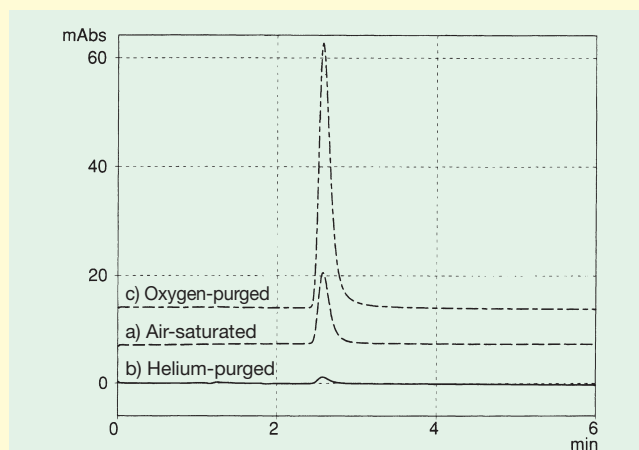

Fig. 1 Peaks That Appear When Mobile Phase Injected (Actual Mobile Phase Degassed)

### Analysis Conditions

Sample: 10  $\mu$ L of mobile phase, a) air-saturated, b) helium-purged, c) oxygen-purged  
Column: STR ODS II (4.6  $\times$  150 mm)  
Mobile phase: Methanol/water = 85/15, degassed  
Flow rate: 1 mL/min  
Temperature: 40  $^{\circ}$ C  
Detection: 210 nm

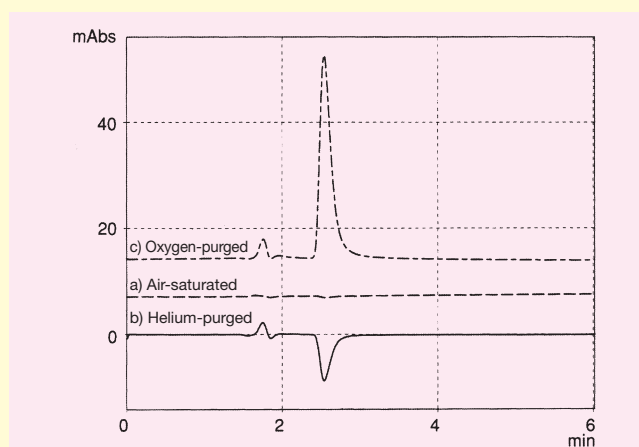

Fig. 2 Peaks That Appear When Mobile Phase Injected (Actual Mobile Phase Not Degassed)

### Analysis Conditions

Mobile phase not degassed. Otherwise, same as Fig. 1.

These changes in absorbance do not correspond to the solvents' oxygen solubility levels. For example, hexane has a much higher oxygen solubility level than methanol<sup>1)</sup> but the change in absorbance for hexane is smaller. We can therefore conclude that the absorbance originates in the interaction between oxygen and the solvent, rather than the absorbance of oxygen itself.

## 3. Elution Position of Peaks

There is a tendency to think that peaks originating in dissolved oxygen are eluted quickly. Like the retention behavior of the sample



constituent, however, elution occurs later if the proportion of methanol in the mobile phase is reduced. Fig. 5 shows an example of elution in which the mobile phase and the sample solvent have the same solvent composition. The same tendency is also exhibited when phosphate buffer solution is used instead of water. It is possible, then, that this peak may not separate from the target constituent. This peak becomes smaller as the proportion of methanol becomes lower.

#### 4. Checking Peaks Possibly Caused by Dissolved Air

The following criterion can be used to check any suspicious peak that appears while using a gas-liquid separation membrane degasser. If this criterion is satisfied, there is a high possibility that the peak originated in dissolved air.

- 1) Peaks of almost the same size appear at almost the same elution position when the sample solvent and the injection volume are the same. The sample solution is agitated (shaken) or left in a semi-open system in order to saturate it with air. When the sample solvent is diluted and "X" times the volume is injected, approx. "X" times the area is obtained.
- 2) Mobile phase (air-saturated) is injected and the elution time at which the peak appears is the same as that for the suspected peak. When mobile phase is injected after degassing (by purging with helium for about 10 s), the peak becomes smaller.
- 3) When the mobile phase is delivered without passing it through a degasser, and the sample solution is injected, the peak becomes smaller. If air-saturated mobile phase is injected, the peak definitely becomes smaller than it was in 2). It may not necessarily become smaller, however, if the sample-solvent composition differs greatly from the mobile phase.

#### 5. Countermeasures

It is difficult to completely remove peaks originating in dissolved air but we will look at some ways of making them smaller. (Here it is assumed that a methanol/water mobile phase is used.)

- 1) Replace the methanol mobile phase with an acetonitrile one (for HPLC). When replacing, consider the elution capacity and the separation selectivity. (Refer to page 6.)  
→ If changing the conditions is possible, this is the best method.
- 2) Lower the proportion of methanol in the mobile phase. Replace the column with one that is suitable for analysis (i.e., a column with low retention or a short column).  
→ Not using ODS means that flexibility is lost, and technical knowledge is also required.
- 3) Stop online degassing of the mobile phase.  
→ This method is not recommended because the generation of bubbles in the flow line may adversely affect the quantitative accuracy and stable detection may not be possible.
- 4) Degas the sample solution before injection. The solution can be substantially degassed by purging with helium for approx. 10 s.  
→ A lot of effort is required and this method may not be very effective for continuous operation.

The following methods can be used to improve separation from the target constituent.

- 1) If the target constituent is ionic, change the elution position of the target constituent by changing the pH value of the mobile phase.
- 2) Change the type of organic solvent used.

These aspects should generally be considered as part of method development.

As described above, even if a ghost peak is somehow judged to originate in dissolved air, there may be many cases where the problem cannot be solved easily. Even so, ascertaining the cause is extremely important for the personnel developing and controlling the analysis conditions.

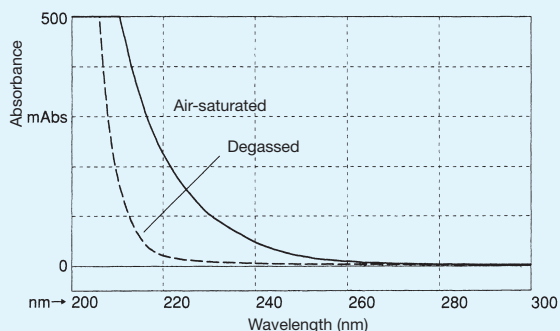

Fig. 3 Influence of Degassing on Methanol Spectra

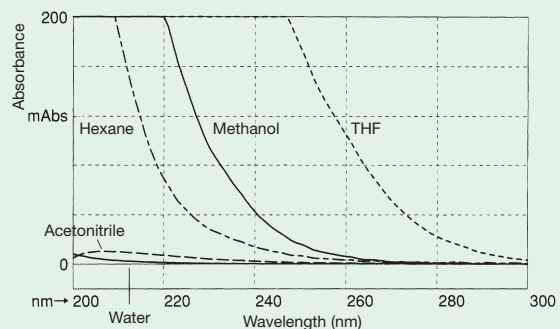

Fig. 4 Differential Spectra Showing Increase in Absorbance of Solvents Due to Dissolved Oxygen\*

\*Obtained by subtracting solvent spectra for the degassed state from solvent spectra from the air-saturated state.

Water: Purified water; Acetonitrile: HPLC type; Methanol: HPLC type; THF (Tetrahydrofuran): HPLC type; Hexane: HPLC type

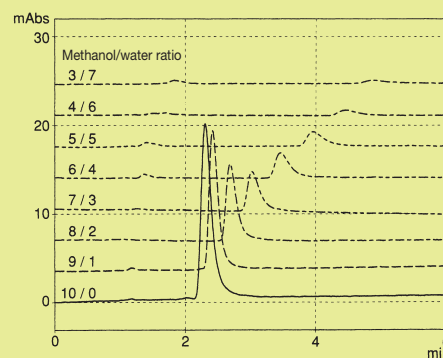

Fig. 5 -Examples Showing Influence of Proportion of Methanol in Mobile Phase on Elution Position and Area

(The elution position varies with the column history.)

Analysis Conditions

Sample: 10  $\mu$ L of mobile phase, air-saturated

Column: STR ODS II (4.6  $\times$  150 mm)

Mobile phase: Methanol/water (proportions given in graph), degassed

Flow rate: 1 mL/min

Temperature: 40  $^{\circ}$ C

Detection: 210 nm

- 1) S.R. Bakalyar, M.P.T. Bradley and R. Honganen, *J. Chromatogr.*, 158, 277-293 (1978)

# Influence of Sample Solvent on Peak Shape

Have you had the following experiences with reversed-phase analysis?

- Even though the same volume of standard solution (methanol solvent) and sample solution (aqueous extract) are injected, for some reason the constituent peak obtained for the standard solution is broader.
- When injecting methanol solvent, doubling the injection volume has an extremely bad effect on the separation.

Here we will look at some possible causes of these problems.

Fig. 1 shows how the number of theoretical plates ( $N$ ) for caffeine changes when the sample solvent is changed. If a sample solvent with the same methanol/water ratio as the mobile phase (3/7) is used, a clear drop in  $N$  (i.e., the peak gets thicker) can be observed for injection volumes of 100  $\mu\text{L}$  or more.

If 100% methanol is used, a drop in  $N$  is observed for injection volumes of just 10  $\mu\text{L}$  or more, and readings are obtained above this level. (See Fig. 2.) For an injection volume of 100  $\mu\text{L}$ , elution starts very early (almost no retention) and takes place gradually, and a result of  $N < 100$  is obtained. While in the column, the sample solvent can be regarded as part of the mobile phase and so, in this case, it is possible that the sample solvent acted as a mobile phase with a high elution capacity and moved the constituent quickly.

On the other hand, when 100% water was used, a drop in the number of theoretical plates was not observed, even though a relatively large volume (1 mL) was injected. In fact, there was a slight increase overall. Also, the retention time was 1 minute later. This was probably because the sample solvent acted as a mobile phase with a low elution capacity and so the caffeine was concentrated at the column inlet, and the separation process started once again in the mobile phase.

In other words, the effect was similar to point injection. We can see, then, that if the sample injection volume is relatively large, the type of sample solvent has a large influence on the peak shape and the retention time. This point requires attention in method development.

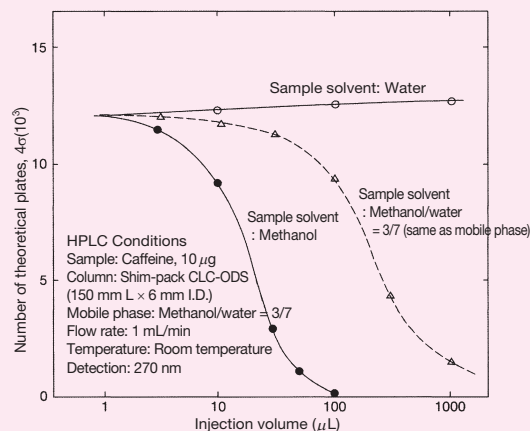

Fig. 1 Influence of Sample Solvent on Number of Theoretical Plates

The concentration is divided by a factor of 10 when the injection volume is increased by a factor of 10, and the absolute injection volume for caffeine at each of the injection points is fixed at 10  $\mu\text{g}$ .

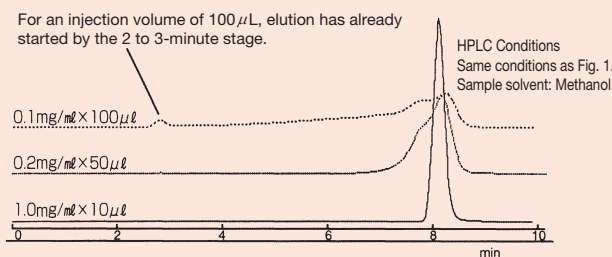

Fig. 2 Examples of Peak-Shape Changes for Injection of Sample Solvents with High Elution Capacity

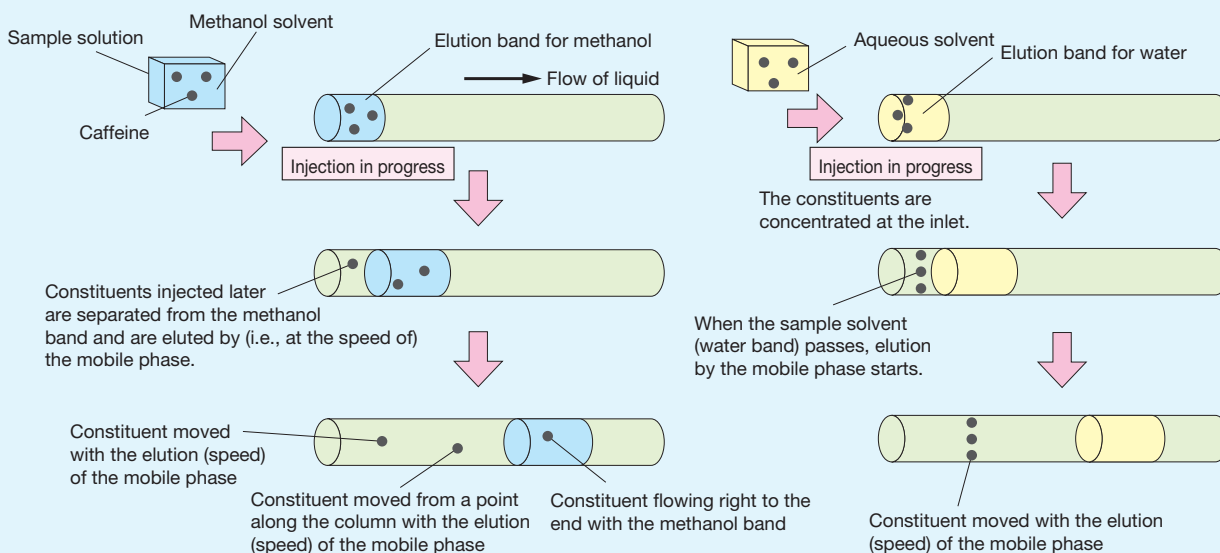

Fig. 3 Comparison of Methanol Solvent (Left) and Aqueous Solvent (Right) Used as Sample Solvent in High-Volume Injection

# Check Methods for Abnormal Increases in Solvent Delivery Pressure

## 1. Introduction

We often get the following sort of telephone inquiry: "The column pressure has increased. Do I have to replace it?" However, it often turns out that the solvent delivery unit had reached the maximum pressure and stopped, and that the problem (clogging) was not in the column, but in another place. Here, we will look more closely at this problem.

## 2. Background Knowledge

### <Problems That May Occur with Abnormal Increases in Solvent Delivery Pressure>

Let us look at the problems that may occur when there is an abnormal increase in the solvent delivery pressure.

- A. If too much pressure is applied on the column-filling material, the material may crack or become flattened, and be pushed inside. This means that further pressure is applied. If a gap opens at the inlet-filling section, peaks are deformed. With size-exclusion chromatography, the pore size becomes smaller and so separation is adversely affected. Pressure is applied downstream from the column, and if the pressure gradient of the column itself is low, damage is relatively slight.
- B. If too much pressure is applied to the detection cell itself, there may be a liquid leakage or the cell may crack.
- C. If tubes or filters become clogged with insoluble matter, liquid may not flow smoothly, and constituents may adsorb to these parts, causing deformation of peaks.
- D. If the solvent delivery pressure becomes too high, solvent delivery may not be possible at the prescribed flow rate. Also, the service life of consumable parts may be shortened.

### <Setting the Solvent Delivery Unit's Maximum Pressure>

In order to detect abnormalities earlier, the maximum pressure of the solvent delivery unit is set to a value between 1/2 and 2/3 of the column's withstand pressure (10 to 15 MPa for a 5  $\mu\text{m}$  silica analysis column). If there is a resistance tube<sup>1)</sup> (see Fig. 1), a high-sensitivity damper<sup>2)</sup>, or a pre-column<sup>3)</sup> between the solvent delivery unit and the injector, because pressure is applied on it, the corresponding pressure is added to the value set for the maximum pressure.

## 3. Check Methods for the Flow Line

### <First, check the mobile phase bottle.>

If white turbidity is visible in the mobile phase bottle, it is probably insoluble matter that has built up in the flow line. Although there is a suction filter, this occurs because the downstream filter pores are often smaller. Even if the mobile phase is filtered, deposition may occur later if there is little leeway in the solubility of the solute.

On the other hand, using only purified water may result in the propagation of bacteria. With the gradient elution of buffer solution and organic solvent, use a beaker or a flask to check beforehand that there is no deposition after mixing. Depending on the mixing ratio, white turbidity may even occur when organic solvents are mixed together. If white turbidity or deposition occurs, in addition to rinsing the flow line, reconsideration of the mobile phase is also required.

### <In general, remove tubing in order from the downstream end when checking the flow line.>

In order to identify the place where abnormally high pressure is occurring, the tubing is, in general, removed in order from the downstream end, solvent is delivered, and the pressure is checked. If the maximum pressure is reached quickly, the flow rate is lowered and the procedure is repeated.

First, connection (1) in Fig. 1 (check for back-pressure tube<sup>4)</sup>) is removed and solvent is delivered. If the pressure drops suddenly (by several hundred kPa or more), then this indicates clogging in the back-pressure tube. If it does not drop, it indicates that the clogging is further upstream and so, next, connection (2) (check for detector) is removed and investigated. After this, connections (3) (analysis column), (4) (guard column, line filter), (5) (injector), (6) (resistance tube, pre-column, etc.), and (7) (solvent delivery unit's line filter) are investigated in the same way. In some cases, other connectors are removed. When checking the tube, cell, filter, or injector, there is a problem if a pressure of several hundred kPa occurs at the part itself. (A pressure of several hundred kPa may naturally occur in tubing for semi-micro systems.) Clogging is liable to occur at filters and at the inlets to fine tubes and so these places require particular attention.

Flow line checks for the column oven interior are performed with the oven open, in other words, at close to room temperature. Therefore, delivering solvent at the same flow rate used in analysis may result in too much pressure being applied to the column. It should normally be acceptable to deliver at around half the flow rate.

## 4. Solutions for Different Parts of the Flow Line

There are parts of the flow line where clogging can be rinsed away (i.e., dissolved) and parts where it cannot. (See Table 1.) In cases where it cannot, either the flow is reversed or that section of tubing is replaced.

### <Tubing>

Parts prone to clogging include the junctions between tubes with a large inner diameter and fine tubes, and parts where the flow line bends. (See Fig. 2.)

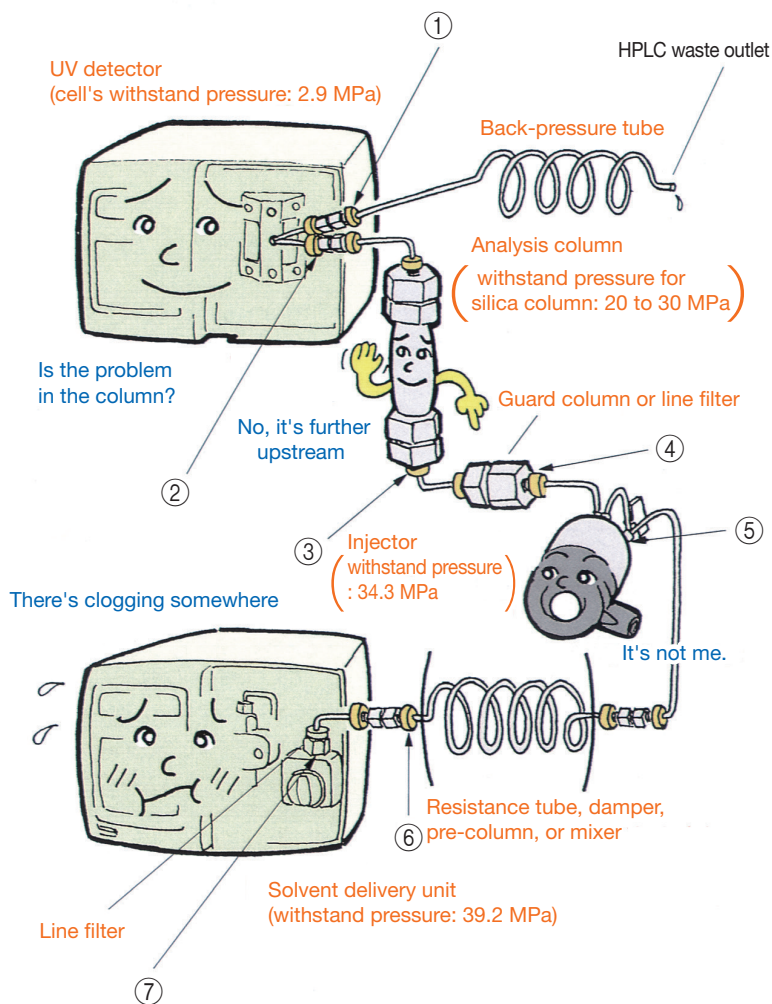
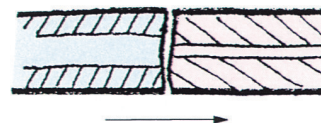

Fig. 1 The clogged part of the flow line can be identified by removing tubing in order from the downstream end and checking the pressure.

Joints between tubes with a large diameter and fine tubes



Places where the flow line bends

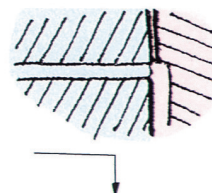

Fig. 2 Places Prone to Clogging

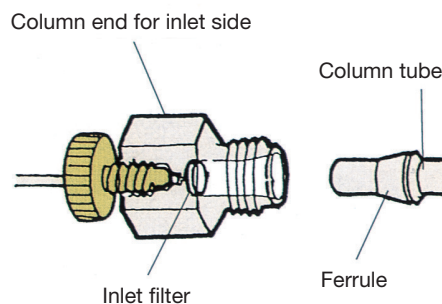

Fig. 3 Case where input filter is integrated with column end

Table 1 Examples of Clogging and Rinse (Dissolving) Solvents

Type of clogging		Rinse (dissolving) solvent
Soluble	Low-polarity compounds	Organic solvent
	Salts	Water, acidic water*, basic water
	Metal powder	0.1 N nitric acid solution
Insoluble	Dirt, dust large metal particles	There is no appropriate rinse solvent and so try reversing the flow.

\* For example, 1% acetic acid solution.

Table 2 Examples of Solution Combinations That Should Not Be Mixed Directly

Solution combination	Problem	Countermeasure
Water and low-polarity solvent	Emulsion	Use 2-propanol or acetone as substitute solvent
Buffer solution and organic solvent	Deposition	Use water as substitute.
Nitric acid and alcohol	Reaction	Use water as substitute.





There are many cases where the problem is solved by cutting a length of approx. 1 cm off the inlet end of the tubing. (Therefore, it is convenient to use a hand-tightened PEEK male nut for the connector.)

#### <Detector Cell>

If the pressure of the UV cell is extremely high, rinsing is performed after disassembling the cell in order to prevent cracking.

#### <Column>

If the column pressure is quite high, a column check is performed (measurement of the number of theoretical plates under the manufacturer's specified conditions) to investigate whether or not it satisfies the requirements of the intended purpose. If the pressure is extremely high, as a general rule, the column is typically replaced. If there is clogging in the filter in the inlet side's column end, however, it may be possible to solve the problem using the following method, although the success of this method is not assured.

- ① The flow rate is reduced by half and the flow is reversed.
- ② The pressure applied to the inlet side's column end is investigated. (Fig. 3 shows the case where the input filter is integrated with column end.) If that pressure is high, ultrasonic cleaning is performed, and if this is not successful, the end is replaced. In some cases, however, the new end and the ferrule (see Fig. 3) cannot be closely connected. In this case, vulcanized tape is used to prevent liquid leakage. If the filter can be removed from the end, it is replaced.

If the inlet side's filter seems to become clogged often, it is advisable to insert a line filter between it and the injector. This may, however, cause slight broadening of the peaks.

#### <Line Filter, Injector>

Either the flow is reversed or the relevant part is disassembled and subjected to ultrasonic cleaning.

### 5. Considerations for Different Situations

#### <Using after a long interval:>

When using the equipment after a long interval, or if the previous operating conditions are unclear, the flow line is first rinsed with the column removed.

#### <Pressure extremely high even when solvent delivered at low flow rate:>

If the maximum pressure is soon reached when the solvent is delivered at a low flow rate, instead of removing parts in order from the downstream end, remove the whole flow line, starting from the upstream end, and connect each part directly to the solvent delivery unit to investigate it.

#### <Pressure increases gradually each time sample is injected:>

This could be because of insoluble matter in the sample or matter that dissolves in the sample solvent but not in the mobile phase.

#### <Pressure increases a little on injection and then decreases:>

This could be because of insufficient solubility of the sample constituent or an increase in the viscous resistance pressure that occurs when the sample solvent and mobile phase are mixed.

### 6. Points to Note in Daily Analysis

#### <Filter the mobile phase and sample solvent.>

Be sure to filter the mobile phase and, in particular, the sample solution with a membrane filter. Also, mix together solutions used in a gradient system, and the mobile phase and the sample solution, and check that there is no insoluble matter.

#### <Get into a habit of recording the pressure during analysis.>

In order to ensure the early discovery of problems, make a record of the pressure whenever analysis is performed.

#### <Perform zero-adjustment of the solvent delivery unit.>

In order to ensure accurate pressure monitoring, perform zero-adjustment on a regular basis. Zero-adjustment is performed with the drain valve open with no solvent flowing.

#### <Take appropriate measures for the tip of the detector's outlet tube on completion of analysis.>

Because the tip of the detector's outlet tube (back-pressure tube) is in contact with the air, the solvent in the tube is in a position prone to evaporation. On completion of analysis performed using a buffer solution, either insert the tip of the tube in the waste (replace if cloudy) or wrap it in parafilm. If the equipment is not going to be used for several days, remove the column, and replace the contents of the HPLC flow line with water and then methanol. When using a mobile phase that may shorten the column's service life, thorough rinsing should, of course, be performed before storage.

- 1) Resistance tube: The resistance tube referred to here is a tube with, for example, a length of 2 m and an inner diameter of 0.1 mm. It connects to the solvent delivery unit's outlet and, it is used to improve the action of solvent delivery unit's high-pressure damper, by adding several MPa to the pressure applied with the analysis flow rate.
- 2) High-sensitivity damper: This damper is used to reduce the pump pulsation, and obtain a high-sensitivity baseline for the conductivity, the electrochemical behavior, the refractive index, and all other detected items. It is usually used together with a resistance tube.
- 3) Pre-column: This column is installed upstream from the injector for the purpose of protecting the analysis column from the mobile phase.
- 4) Back-pressure tube: This is a resistance tube that is connected to the downstream side of the detector cell (i.e., the back). A tube with a length of 2 m and an inner diameter of 0.3 mm is usually used with UV detectors. The pressure applied when water or methanol is caused to flow at 1 mL/min is in the range 100 to 200 kPa. It is used if bubbles are formed when the cell unit is almost at atmospheric pressure.

Note:  $1 \text{ kgf/m}^2 \approx 9.8 \text{ Pa} \approx 0.0001 \text{ kgf/cm}^2$

# Internal Standard Method

▶ Although the absolute calibration method is commonly used as a quantitation method for HPLC, there are cases where it yields large errors. In particular, fixed volumes of standard solutions and sample solutions must be injected accurately when using this method. It is almost impossible to avoid errors when injecting extremely small sample volumes. With the internal standard method, in order to remove this kind of error, known volumes of an internal standard (I.S.) substance are added to the standard solution and the sample solution. The ratio of the peak sizes for the substance and the target constituent are obtained, and this is used to perform quantitation. Because this method is a relative method, not only does it compensate for inconsistencies in the injection volumes mentioned above, it also compensates for the influence of the measurement conditions on the analytical values. For example, it inhibits the influence of fluctuations in the mobile-phase delivery volume, drops in the energy level of the lamp light source, evaporation of the sample solvent, and changes in the composition of the mobile phase. Another important application is the way it is used to compensate for errors (recovery-rate errors) that occur in sample pretreatment.

▶ I.S. substances must satisfy the following conditions and consequently selection can sometimes be difficult.

- 1) Its peak must be completely separated from the peaks for other constituents contained in the sample.
- 2) It must not already be contained in the sample.
- 3) It must be eluted close to the target constituent.
- 4) Its chemical structure must be similar to that of the target constituent.
- 5) It must be chemically stable and easy to obtain.

(If the purpose is only to compensate for inconsistencies in injection volume, condition 4) is not required.)

▶ Let us look more closely at the internal standard method by considering an example of its practical application. Here, we will look at the analysis of theophylline (pharmaceutical) in blood serum performed using etophylline as the I.S. substance. First, several

standard solutions of theophylline with different concentrations are prepared (e.g., 10, 20, 30, and 40  $\mu\text{g/mL}$ ). Etophylline solution (approx. 20  $\mu\text{g/mL}$ , 1-N perchloric acid solution) is prepared as the I.S. solution. After mixing 1 mL of each of the theophylline standard solutions with 0.5 mL of the I.S. solution, approx. 10  $\mu\text{L}$  of each mixture is injected, and the ratio of the peak areas is obtained for theophylline and the I.S. substance. (See Fig. 1.) The kind of calibration curve shown in Fig. 2 is created from the data obtained. The X-axis represents the concentration ratio ( $C_x/C_s$ ; x: theophylline; s: I.S. substance) and the Y-axis represents the area ratio ( $A_x/A_s$ ). In fact, the same I.S. solution is added to the blood serum and so, because  $C_s$  is constant, the X-axis in this case is used to represent the theophylline concentration (" $C_x$ " in the graph). Next, 1 mL of blood serum is mixed together with 0.5 mL of I.S. solution. After centrifugal separation, approx. 10  $\mu\text{L}$  of supernatant is injected, and the area ratio for theophylline and I.S. is obtained from the resulting chromatogram (Fig. 3). If this ratio is 0.75, for example, then we can deduce from Fig. 2 that the concentration of theophylline in the blood serum is 15  $\mu\text{g/mL}$ .

▶ In the example, the solvent for the I.S. solution is 1-N perchloric acid, which also functions as a protein removal solution. In this case, the purpose is not just compensation for inconsistencies in injection volume but also compensation for inconsistencies in pretreatment (i.e., compensation for changes in liquid volume resulting from protein removal) and so etophylline, which has a structure very similar to theophylline, is selected as the I.S. substance. (In particular, compounds that cause protein adsorption are not suitable in this case.) It goes without saying that care is required to ensure that each peak lies within the range for which the linearity of the detector response is maintained.

▶ As mentioned above, although the internal standard method involves quite a lot of restrictions regarding the selection of I.S. substances, it is a quantitation method that offers a higher degree of accuracy.

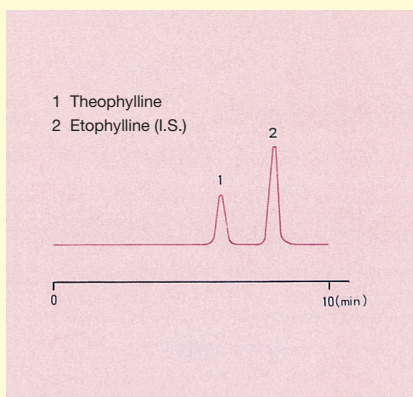

Fig. 1 Chromatogram for Standard Substance (10  $\mu\text{g/mL}$  of theophylline)

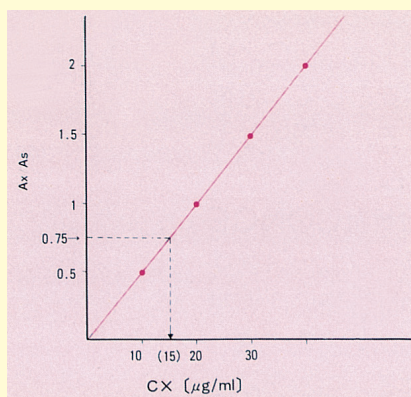

Fig. 2 Calibration Curve

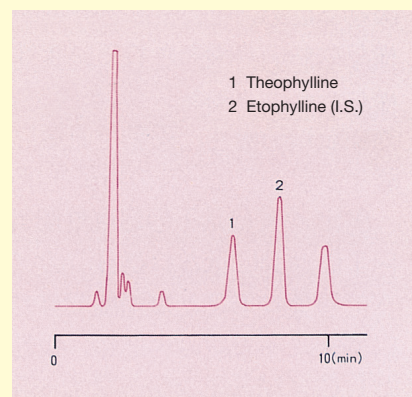

Fig. 3 Chromatogram for Blood Serum

# Formulas for Number of Theoretical Plates

The number of theoretical plates (N) is an indicator used to assess the performance and efficiency of a column, and is expressed by formula 1).

$$N=16 \left( \frac{tr}{W} \right)^2 \dots 1) \quad tr: \text{Retention time; } W: \text{Peak width}$$

For a Gaussian peak, this peak width, W, is spanned by the points where the peak tangents intercept the baseline, and is equal to the width at 13.4% of the peak height.

In order to simplify calculation and handle non-Gaussian peaks, the following formulas are used at facilities conducting analysis. These include the half peak height method, which is often encountered in JP (Japanese Pharmacopeia) and elsewhere.

### ① Half Peak Height: JP

Calculation is performed using the width at half the peak height ( $W_{0.5}$ ). This method is used widely as calculation by hand is fairly simple. It is also used in DAB (German Pharmacopeia), BO (British Pharmacopeia), and EP (European Pharmacopeia). (However, 5.54 is used as the coefficient that appears in 2.) With peaks that spread out towards the bottom, this formula gives a larger value for N than other formulas.

$$N=5.55 \left( \frac{tr}{W_{0.5}} \right)^2 \dots 2)$$

### ② Tangent: USP (United States Pharmacopeia)

Calculation is performed with formula 1) taking as the peak width the section spanned by the points where the tangents at the inflection points on the right and left of the peak intercept the baseline. If the peak overlap is large, N is small. Problems occur when, for example, the peak is deformed and there are multiple inflection points.

$$N=16 \left( \frac{tr}{W} \right)^2 \dots 1)$$

### ③ Area/Height

Calculation is performed using the peak's area and height. Although a comparatively high level of accuracy and reproducibility can be attained even if the peak is deformed, if the peak overlap is large, a large value is calculated for N.

$$N=2\pi \left( \frac{tr \cdot H}{A} \right)^2 \dots 3) \quad A: \text{Area; } H: \text{Height}$$

### ④ EMG (Exponential Modified Gaussian)

Parameters reflecting consideration of the asymmetry of the peak are introduced, and the width at 10% of the peak height ( $W_{0.1}$ ) is used. Because the width near the baseline is used, with peaks that spread out towards the bottom, this formula gives a smaller value for N than other formulas. Also, calculation is not possible if the peaks are not completely separated.

$$N=41.7 \frac{\left( \frac{tr}{W_{0.1}} \right)^2}{\frac{b_{0.1}}{a_{0.1}} + 1.25} \dots 4) \quad \begin{array}{l} a_{0.1}: \text{Width of peak's front half at 10\% of height} \\ b_{0.1}: \text{Width of peak's back half at 10\% of height} \\ \text{(for tailing peak)} \end{array}$$

These formulas give the same value of N for Gaussian peaks. Peaks usually exhibit some degree of tailing, however, and this gives rise to differences in the value of N. (See Table A.) If there is severe peak deformation (e.g., Peak 1 in Table B), then the value of N can be several times as large or small. This can make the task of deciding which formula to use quite difficult.

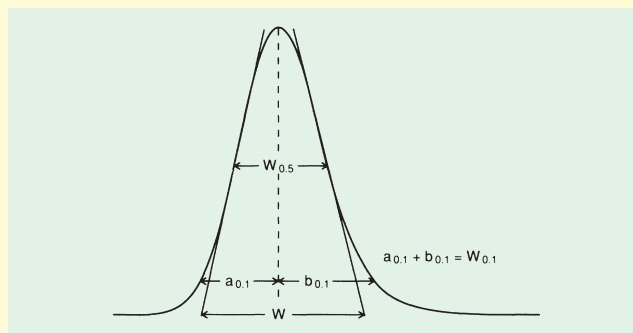

Fig. 1 Peak Width

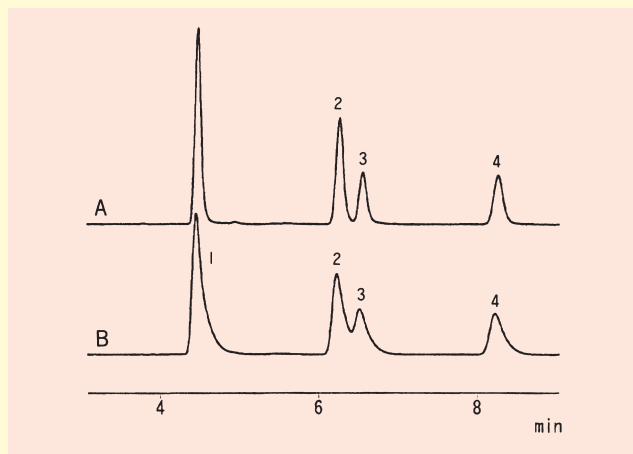

Fig. 2 Chromatograms

	A (slight tailing)				B (significant tailing)			
	1	2	3	4	1	2	3	4
Half peak height (JP)	15649	20444	20389	22245	5972	7917	—	9957
Tangent (USP)	14061	18516	20309	21447	5773	7692	5795	9707
Area/height	13828	19207	17917	21020	4084	7845	6217	8641
EMG	10171	15058	14766	17836	1356	—	—	4671

Number of Theoretical Plates for Peaks

Whether or not separation is possible is an important point in relation to reliable quantitation and so the opinion that formulas that are strict on peaks that spread towards the bottom (tailing) is quite a common one. Unfortunately, there is no consensus on how to regard N and W. Therefore, if evaluation is already being performed using a specific method, then in order to ensure consistency, it is considered advisable to continue using the same method.

With Shimadzu's CLASS-VP HPLC workstation, performance reports can be output using any of the above four methods. Use this feature to record the column performance results together with the analysis results.



Shimadzu Corporation  
[www.shimadzu.com/an/](http://www.shimadzu.com/an/)

Company names, product/service names and logos used in this publication are trademarks and trade names of Shimadzu Corporation or its affiliates, whether or not they are used with trademark symbol "TM" or "®".  
Third-party trademarks and trade names may be used in this publication to refer to either the entities or their products/services. Shimadzu disclaims any proprietary interest in trademarks and trade names other than its own.

For Research Use Only. Not for use in diagnostic procedures.  
The contents of this publication are provided to you "as is" without warranty of any kind, and are subject to change without notice. Shimadzu does not assume any responsibility or liability for any damage, whether direct or indirect, relating to the use of this publication.